

Pubd in 2 pts.

1 M. 1-288

1824

2 289-end

1826

MEMOIRS

OF THE

WERNERIAN

NATURAL HISTORY SOCIETY.

MEMOIRS

W. H. HARRIS

NATURAL HISTORY SOCIETY

MEMOIRS

S. 58.

OF THE

W. H. HARRIS

NATURAL HISTORY SOCIETY

MEMOIRS

W. H. HARRIS

NATURAL HISTORY SOCIETY

1881

Botanical Department

MEMOIRS
OF THE
WERNERIAN
NATURAL HISTORY SOCIETY.

VOL. V.

FOR THE YEARS 1823-24.

PART I.

WITH SEVEN ENGRAVINGS.

EDINBURGH:

PRINTED FOR

ADAM BLACK, NORTH BRIDGE, EDINBURGH;

AND LONGMAN, HURST, REES, ORME, & BROWN,

LONDON.

1824.

MEMOIRS

OF THE

WERNERIAN

NATURAL HISTORY SOCIETY.

VOL. V.

FOR THE YEARS 1833-34.



PRINTED BY

EDINBURGH:

PRINTED FOR

ADAM BLACK, NORTH BRIDGE, EDINBURGH;

AND TOWNMAN, NORTON, BIRMINGHAM, & BROWN,

LONDON.

1834

P. NEILL, Printer.

CONTENTS

OF

PART I. OF VOL. V.

	Page.
I.— <i>An Account of the Foramen centrale of the Retina, generally called the Foramen of Scemmering, as seen in the Eyes of certain Reptiles.</i> By Dr R. Knox.	1
II.— <i>Observations on the Lesser Guillemot and Black-billed Auk, the Colymbus Minor and the Alca Pica of Linnæus.</i> By L. Edmondston, Esq.	8
III.— <i>Observations on the Anatomy of the Duck-billed Animal of New South Wales, the Ornithorynchus paradoxus of Naturalists.</i> By Dr R. Knox.	26
IV.— <i>Tentamen Methodi Muscorum; or, A New Arrangement of the Genera of Mosses, with Characters, and Observations on their Distribution, History, and Structure.</i> By R. K. Greville, LL. D., and G. A. W. Arnott, Esq.	42
V.— <i>Register of the Weather at Corfu, during the Months of August, September, October, and November, 1821.</i> By Mathew Miller, Esq.	90
VI.— <i>Additional Observations relative to the Foramen centrale of the Retina in Reptiles.</i> By Dr Knox.	104

	Page.
VII.— <i>Contribution to a Natural and Economical History of the Coco-Nut Tree.</i> By Mr Henry Marshall, Surgeon. - - - -	107
VIII.— <i>Observations on the Organs of Digestion and their Appendages, and on the Organs of Respiration and Circulation, in the Ornithorynchus paradoxus.</i> By Dr R. Knox. - - - -	144
IX.— <i>An Account of a Series of Thermometrical Observations, made hourly at Leith, during Twenty-four successive Hours, and once every Month, from July 1822 to July 1823.</i> By Mr John Coldstream. - - - -	175
X.— <i>Notice of a Journal of a Voyage from Rio de Janeiro to the Coast of Peru, by Mr William Jameson, Surgeon.</i> By G. A. W. Arnott, Esq. 187	187
XI.— <i>Inquiry into the Origin and Characteristic Differences of the Native Races inhabiting the Extra-tropical Part of Southern Africa.</i> By Dr R. Knox. - - - -	206
XII.— <i>A Monograph of the Genus Pyrola.</i> By Mr David Don. - - - -	220
XIII.— <i>Descriptions, Characters, and Synonyms of the different Species of the Genus Larus, with Critical and Explanatory Remarks.</i> By Mr William Macgillivray. - - - -	247
XIV.— <i>Sketch of the Geographical Distribution of Plants in Yorkshire.</i> By J. Atkinson, Esq. - 277	277
XV.— <i>On a new British Species of Spatangus.</i> By the Rev. Dr Fleming. - - - -	287

List of Engravings in Part I. of Vol. V.

- PLATE I. Represents the Poison-gland and Duct in the foot of the *Ornithorynchus Paradoxus*; described at p. 40.
- II. Illustrative of the Characters of the genera *Gymnostomum*, *Schistostega*, *Anictangium*, and *Hedwigia*; pp. 54, 60, 66, 71.
- III. Illustrative of the characters of the genera *Diphygium* and *Buxbaumia*; pp. 78, 88.
- IV. Represents the Foramen centrale as seen in the eye of the *Lacerta superciliosa*, and of Apes; described at p. 105.
- V. Represents the complex Clavicle and Scapulæ of the *Ornithorynchus paradoxus*, and the Sternum of a Fossil Animal; described at p. 172.
- VI. Organs of Generation in the Male *Ornithorynchus*; described at p. 174, under Art. 4. Also, *Spatangus ovatus*; described at p. 288.
- VII. Cranium of a Kaffre; alluded to at p. 211. Also, Female Figure from the Cave of Elephantina, noticed at p. 216.

ADVERTISEMENT.

IN laying its Memoirs before the Public, this SOCIETY does not hold itself as responsible for the facts or opinions which may be advanced on the various topics of Natural History that are discussed. These, accordingly, must be distinctly understood as resting entirely on the individual authority of the respective Writers who have favoured the Society with Communications.

MEMOIRS, &c.

I.—*An Account of the Foramen centrale of the Retina, generally called the Foramen of Sœmmering, as seen in the Eyes of certain Reptiles.*

By ROBERT KNOX, M. D. M. W. S. Med. Ch. Soc. &c.

(*Read 15th November 1823.*)

WHEN Dr SÆMMERING announced his discovery of a transparent point or *foramen* in the human retina, nearly, or, as some say, precisely in the axis of vision, it excited very strongly the attention of anatomists, and of the philosophic world generally. It was indeed a singular circumstance, that so remarkable, and so easily detected, an appearance should have escaped the observation of the distinguished anatomists who preceded SÆMMERING. The public attention having been much roused, numerous researches were immediately instituted by many English and foreign Anatomists, with the view of determining whether this perforation, or transparent portion of the retina, was

peculiar to man, or was extended to other species of vertebral animals. The result of these inquiries, so far as I have been able to collect, is as follows.

—“ In Man,” (observes BARON CUVIER, *Anat. Compar.* t. ii. p. 422.), “ there is, near the entry of the nerve, and almost at the point which corresponds to the axis of the eye, a small fold of the retina, which forms a slight convexity, when the more external membranes are removed. In the midst of this fold there is a transparent point, which at first sight appears like a hole; the edges of this point are tinged with yellow in adults, but not in the new-born infant. This peculiarity of the human eye, which had escaped the observation of all anatomists before SCÆMMERING, is found in no other animal, except in monkeys. We have observed it in the *Cynocephalus*, in the *White-nosed Guenon*, &c. In the first, the transparent part is considerably larger than in man, and of an oval form: there is sometimes a yellow spot at its side.

“ The Maki, which of all Mammalia approaches nearest the monkeys, has only a slight fold, without any spot or transparent point. The other species have nothing similar.”

These facts, and others, relative to the pathology of this *foramen* in the human retina, were pointed out by many distinguished comparative anatomists. The yellow spot or tinge, more or less surrounding the foramen, is said to be wanting when vision has been obstructed; and the plait is small and wrinkled. In monkeys, the yellow spot is occasionally absent. The important fact, that the appearances are limited to the eyes of man and a few quadrumanous animals, has been much dwelt on by physiologists, whilst the existence of a *foramen*, or transparent point of the membrane of the retina, situated in the actual line of vision, has been deemed by most absolutely inexplicable.

In a work just published by DE BLAINVILLE, a distinct and direct allusion is made to a theory, partially supported by nature, but which, in the present instance, is not applicable.

It is there remarked *, that “ the differences which the Mammalia present, in the point of view we at present consider, are always susceptible of being divided into two categories; the one sort, pretty nearly inexplicable, is connected with what we have called the classical degradation, and with the degree of organisation to which the species belongs; the others are evidently in relation with the medium in which the animal must seek its food, or with the time of day during which it is so employed,—or, finally, perhaps with the nature and kind of its food.”

“ I arrange (he continues) in the first category, the sort of yellow spot, with a small depression, more or less oval, translucent in the middle, around which the retina is somewhat folded, which may be remarked in this membrane at some distance externally from the entrance of the optic nerve, in the axis itself of the globe of the eye. It is found only in the human species, and in the real apes of the Old and New Continent.”

Unfortunately for the ingenious theory just quoted, the transparent point of the retina or foramen, and the fold of the membrane, exist in a class of animals differing widely from man, and from the apes of the Old and New Continent: the class I allude to is Reptiles. I shall here briefly describe the appearances, and the particular species in which I have detected so singular an appearance.

Professor JAMESON having requested me to re-examine with great care my dissections of the class of *Reptiles*, and

* Principes d'Anatom. Compar. p. 375.

having most kindly and liberally furnished me with the necessary specimens from the Museum, and, at the same time, pointed out the works of the comparative anatomists of Germany, with whose labours he is intimately acquainted, I deemed it a favourable opportunity for completing my inquiry into the organ of vision, and of adding to those observations which I had the honour lately to submit to the Royal Society of Edinburgh. It is not my intention here to enter into any details relative to the eye of Reptiles generally, but simply to describe the transparent point, or *foramen centrale*, and fold of the retina, which I have found to be comparatively much more developed in these animals than in man himself.

The animals in which these appearances were discovered by me were all of the Lizard tribe *, and the first in which I remarked the presence of the transparent point, was the *Lacerta superciliosa* of naturalists. The notes taken during the dissection are as follow.

1mo, The eye-ball comparatively large, resembling in external form that of the bird; the sclerotic horny and strong anteriorly, of a bluish colour, soft and elastic posteriorly. The retina very thick, somewhat firm and opaque. Where the optic nerve enters the interior of the eye-ball, there is a distinct marsupium, or black circular body, proceeding forwards apparently through the centre of the vitreous humour: this membrane, no doubt, incloses the bloodvessels distributed to the lens, hyaloid membrane, &c. Anteriorly, somewhat superiorly and towards the mesial line or plane, we perceive, on looking on the surface of the retina which regards the vitreous humour, a comparatively large transparent, nearly circular spot, through

* I ought to remark, that the most of these specimens had been preserved for a great length of time in spirits.

which may be distinguished the dark-coloured *choroid*. Close to this is generally placed a fold or reduplication of the retina, which is in general remarkably distinct. This fold (or folds, for, occasionally, there are more than one), either proceeds from the transparent point towards the insertion of the optic nerve, or close to it. Sometimes the fold seems, as it were, to lie over the transparent point, and partly to conceal it from view; or the point is formed in the edge of the fold itself, as in apes; but, in general, the fold runs directly from the insertion of the optic nerve upwards and inwards, passing very close to the edge of the *foramen centrale*. It will readily be imagined, that the farther dissection of this part of the retina was attended with much difficulty, on account of the smallness of the eyeball. On the inner surface of the retina, and covering even the transparent point, is an excessively delicate vascular membrane, apparently supporting the branches of the central artery of the retina. When we remove the retina from the choroid, the former of these membranes, in some specimens, divides readily into two very distinct layers. The first, or that nearest the vitreous humour, is of an opaque-white, pulpy and thick; the second, or that situated next the choroid, is thin, of a slight bluish cast internally, pale brown externally, and cannot be detached *en masse* from the choroid, though sufficiently large flakes may be forced off with the edge of the knife. Near the Point of Sœmering inwards, towards the insertion of the optic nerve, and around the *foramen centrale*, these two membranes are strongly connected with each other, and cannot be separated. When the whole of the membrane which we generally call retina is removed from the choroid, and drawn gently towards the optic nerve, there is evidently a circular aperture in the retina, constituting the *foramen centrale*, and

6 ACCOUNT OF THE FORAMEN CENTRALE

the choroid has at this point a slight projection inwards*.

I have stated that the fold of the retina is sometimes totally unconnected with the *foramen centrale*, but may be found occasionally proceeding from the point of insertion of the optic nerve outwards. When there are more than one, they resemble radii drawn from the centre of a circle towards its circumference. Sometimes a large deep fold proceeds from the optic nerve towards the edge of the transparent point, and from it outwards in a straight uninterrupted line. It would seem, therefore, that the formation of these folds is accidental, in so far as regards their presence, or absence, or situation; but that they do not depend for their production, as has been supposed, on any mechanical disturbance of the internal parts of the eye-ball after death.

Two specimens of the *Lacerta superciliosa* were examined, and one of the variety called *Scutata*: in all these the above anatomical appearances were remarkably distinct; and being comparatively larger than in man, did not require, in order to be perfectly seen, the aid of magnifying glasses.

Three specimens of a small lizard, agreeing in description with the *Lacerta Calotes* of naturalists, were examined. In these the eye-ball is somewhat less than in the *superciliosa*; but in all other points, as the distribution of the retina, the existence of the transparent point, deep and extensive folds of the retina, &c., the animals entirely agree.

In a very small specimen of the *Lacerta striata*, I observed the retina folded in a remarkable manner, and, by the aid of a strong glass, I thought I perceived a small

* There is in my possession a very beautiful preparation illustrative of this long disputed point.

transparent point situated as usual, and close to the edge of this duplication of the retina: and, in a small variegated lizard, with lobated feet, I observed the *foramen* or *point* very distinctly*.

In the lizard called by naturalists the Gecko, the marsupium is very small, and the *foramen centrale*, or transparent point, is wanting. Neither could I perceive it in the lizard called by naturalists *Lanins* (the *Lacerta Mabuja*); in them also the marsupium is very small, though distinct. We thus discover that the foramen of SÆMMERING is found in a particular family of lizards, whilst it is wanting in others. Analogy would lead us to suspect its presence in the Chameleon, whose eye I have not yet had an opportunity of examining. It remains also to be discovered, whether the same anatomical distribution extends to the higher orders of lizards, as the Iguana, Tupinambis, and Crocodile †.

There remains only a single additional fact which I wish to communicate in this notice; it regards the supposed existence of vessels passing between the foramen of SÆMMERING and the vitreous humour. With the view of determining this point, I opened the eye-ball *in situ* with the greatest care, and watched the removal of the humours from the retina; but however frequent the examination, I could never discover the smallest appearance of blood-vessels, lymphatics, or membranes, connecting at this point the retina and vitreous humour.

* These lizards belong more strictly to the class of true or proper Lizards than either the *Superciliosa* or *Calotes*.

† I have since ascertained that neither marsupium nor *foramen centrale* are present in the Crocodile.

EDINBURGH, }
June 20. 1823. }

II.—*Observations on the Lesser Guillemot and Black-billed Auk, the Colymbus Minor and the Alca Pica of Linnæus.*

By LAURENCE EDMONDSTON, Esq.

Corresponding Member of the Wernerian Natural History Society.

(Read 26th April 1823.)

THE practice of conferring specific distinctions on animals essentially identical, has been, among systematic writers, more general than that of confounding those which are distinct; and in the progress of extended and accurate observation, it becomes perhaps equally advantageous to retrench fictitious species as to discover new ones.

The system of LINNÆUS, long maintaining an influence so powerful and extended, and fixing on certain artificial, and often arbitrarily assumed, external characters, as legitimate grounds of specific difference, contributed much to that excessive and fallacious multiplication of species of which we find so many instances in zoology. This was indeed a very natural result of that artificial system, which it was perhaps expedient and necessary for LINNÆUS to

select in the infancy of that science which his genius and industry so surprisingly advanced. Hence it happened that, in zoology, as in botany, the attention was perpetually in search of some one or two characters which, it was presumed, must necessarily distinguish each individual species. In birds, for instance, the colour of the plumage, especially of certain parts, as the tips of the primary quill-feathers, the tints of the iris, of the bill, feet, or peculiarity of habits, without noting the causes of diversity, were each separately held to be immutable specific distinctions.

It seemed to be forgotten, that it is seldom by one difference, but an assemblage of many, that nature marks specific distinctions; and had this been more frequently kept in view, we should have had less now to unlearn in some of the most interesting and apparently simple walks of natural history.

BUFFON and his followers adopted an opposite, but more erroneous, course,—preferring vivacity and eloquence of description to conciseness and accuracy of systematic arrangement; and their labours are conspicuous chiefly for the elegance of their style.

The modern French school seems peculiarly to have distinguished itself by the variety of its divisions in the higher departments of classification; and a tendency to excessive refinement of nomenclature has perhaps been too frequent in their writings. Authors on classification have outstripped the progress of observers on species, and, amidst the multiplicity of their subdivisions, seem sometimes to have lost sight of one of their chief objects—the discovery and accurate delineation of species. But it is still to this school, next to that of LINNÆUS, to which zoology owes most of its interest and accuracy. The illustrious CUVIER has ennobled and exalted it to the rank in the scale of knowledge

which it has a right to occupy, and has unfolded its intimate connection with physiology and geology.

Discussions that have for their object the enlargement and more accurate knowledge of such a science, will always be candidly appreciated by a mind truly philosophical, though they may be destitute of the parade of diagrams, or the mazy ingenuities of political arithmetic. The period is long past when flippant sneers at the patient and necessarily minute labours of the naturalist were received as wit; it is now practically known that it is infinitely easier to ridicule than to reason; and that nothing is so contemptible as contempt from ignorance.

Another frequent source of error in specific distinctions may obviously be found in the practice of determining species merely from the examination of stuffed specimens, with little of that previous and necessary preparation, alone to be derived from the frequent and continued habit of observing animals in their living state, and ranging over their native haunts untrammelled by persecution or domestication. It could hardly be expected that museums alone could confer that *visus eruditus*, so necessary and useful in discriminating animals from each other, as it is in other subjects of comparison. There is a physiognomy that marks different species, as individuals of the same species are often easily distinguished, when we have frequent opportunities of observing them, which, although difficult to be described, is yet strongly felt by the experienced, and which often affords the hint for the detection of more tangible grounds of difference. What is it chiefly but this that renders the rude fisherman or woodman often more accurate in specifically distinguishing his native animals than the systematic naturalist,—or which enables the shepherd to know each individual of his flock of many hundreds?—differences in their aspect, which by others are inappreci-

able, are to him prompt and certain grounds of distinction. With what superior facilities to the northern naturalist would a native of the tropical regions enter on the description of his indigenous animals, that, for example, of the numerous species of birds of paradise, of humming-birds, parrots, monkeys, insects? and the tropical zoologist would find a difficulty of a similar kind, though not so extensive, in describing our northern animals.

To these causes are mainly to be ascribed much of the difficulty and error which we meet with in the study of zoology, as well as to the immense diversity of its objects; and much requires yet to be supplied, even in one of its most interesting and apparently most accessible branches, Ornithology.

Our knowledge of many species of European birds is still sufficiently defective; and from their being more frequently presented to our observation, and naturally furnishing criterions of distinction for others, they especially require to be clearly known.

In the notices of a few of those species that have occasionally been submitted to the attention of the Society, I have felt the influence of the preceding views, and have uniformly communicated only the result of my own observations, in the first instance.

When I found opinions of others on the same subjects, whether favourable or opposed to my own, I have freely examined them; but have not allowed myself to enter into discussions in regard to all the speculations that have been advanced, as these add but little to the value of ornithological investigation.

I shall have the honour of continuing this series of observations which I have commenced on several northern animals, regarding which obscure notions may still be entertained; and those to which I shall confine my attention

at present, and which aptly illustrate the preceding views, are, the two supposed species of Lesser Guillemot and Black-billed Auk, the *Colymbus Minor* and *Alca Pica* of LINNÆUS.

It cannot but appear surprising that their claims to specific distinction should not long since have been disposed of, and that there should be still naturalists who remain in doubt, or assert their distinction. I was induced to apply particular attention in endeavouring to settle this question, not more from its involving the knowledge of the identity of two species, and opposing established opinions regarding them, than from my desire not hastily to deny the accuracy of the views of MONTAGU, an ornithologist of whose acuteness and industry I entertain so high an estimate; and I feel quite satisfied, that had his opportunities of observation in this instance been more varied and continued, his candour would have induced him to have relinquished opinions which he has so elaborately and ingeniously supported.

Last summer, while in Zetland, I possessed opportunities the most select for determining the weight to be attached to his opinions on these two species, and clearly convinced myself that what I had always believed regarding them was literally correct. I had also collected a regular uninterrupted series of specimens of the Razor-Bill and Foolish Guillemot, from the egg to the full-grown birds, erroneously described as distinct species. And the loss of the parcel, containing also other specimens of interest, from the shipwreck of the vessel by which they were transmitted to this city for the inspection of the Society, I much regret, as it not only deprives me of many conclusive and satisfactory illustrations, but precludes that brevity which I am anxious to observe in discussions of this description.

The opinion which I hold regarding the *Colymbus Minor* and *Alca Pica* is, that they are merely the young, or the old in winter-plumage, of the two species *Colymbus Troile* and *Alca Torda*, the Foolish Guillemot and Razor-Bill. Many ornithologists have maintained that they are separate species, but as MONTAGU has included all that has been advanced for this opinion, I shall examine chiefly what he has stated on this subject.

It has been insisted on as a very strong circumstance in favour of the distinction of the two disputed species, that they are uniformly inferior in size and length of bill to those which are maintained to be their respective species in a state of maturity; but even if this difference of size were admitted, it could not be of any weight in specific distinction:—it is very inconsiderable, and very varying, and can be observed only for a limited time; for, according to MONTAGU, we can have an opportunity of seeing these species of Lesser Guillemot and Black-billed Auk only during the winter months. Is it not very natural to anticipate that the young should not attain the full size of the parent birds for some time? Inferiority of size, therefore, should rather be a presumption against the opinion of their distinction. But, as far as my observations go, there is no uniform difference of size; they are fully as often to be met with equal in size as inferior; and even individuals of the *C. Troile* and *A. Torda* often materially differ in this respect. This irregularity may chiefly be attributed to inequality in their supplies of food, to which they must often be exposed in their earlier age, when the tendency to permanent size is impressed,—from the habit of prematurely committing themselves to a boisterous and capricious element, and, consequently, often being separated from the protection of the parent birds.

The bill is said to be longer in the Foolish Guillemot, and there is an indenture near the point in both mandibles, while, in the Lesser, there are only the rudiments of a slight indentation in the lower mandible. My experience proves that the bill of the Foolish Guillemot is shorter in the young, and gradually lengthens with age. This was the case with those I reared from a few days old till they were ready to fly, when they had acquired precisely the plumage of the Lesser Guillemot; but were still inferior even to it in size and length of bill. The less numerous indentures in the bills, which are regarded by MONTAGU as peculiarly supporting his opinion, seem to me to lead to an opposite one. It is well known (as he himself admits) that the Razor-Bill, so analogous to the Foolish Guillemot in its changes of plumage and habits, has in its young state neither the size of bill, nor the numerous indentations, which it has in the adult.

It is surprising that this analogy should not have excited his suspicion. The white line extending from the bill to the eye in the Razor-Bill, and from the eye down the neck in the Foolish Guillemot, are conceived to be distinctive. In many specimens I examined, during last summer, these marks were absent; and in many specimens of the other two birds I have found them well defined; and the Danish writer MOHR*, in his *Islandik Natur Historie*, expressly mentions this as no ground of distinction.

* In this author I find most of the opinions I entertained on northern sea-fowl fully confirmed. For instance, he distinctly states the *Colymbus Immer* to be the young of the Northern Diver; and mentions not only its capability, but vigour of flight,—a fact which, being so long unaccountably overlooked, gave rise to so many fanciful and ridiculous conjectures to account for its habits and incubation. It is singular that this book, which is one of the best topographical works in natural history, seems so little known. It was published at Copenhagen in the year 1786.

The sulcæ in the bill of the Alca Torda cannot be considered as peculiar, for MONTAGU mentions a specimen of Black-billed Auk shot in February, in which the bill was as much furrowed as in the Razor Bill; and FABRICIUS also says, that all the young Alcæ have the bill less sulcated and coloured than the adults; —“ hinc character de “ sulcis sumptus lubricus satis.”

This I have myself repeatedly verified. It may be strikingly seen in what occurs in the Puffin: and indeed it seems surprising that *its* young should not also have been described as a distinct species, equally as the young Razor-Bill.

The black in the plumage of the Razor-Bill and Foolish Guillemot is less deep, and it extends over the whole head and neck; while, in the others, the throat and sides of the head are white, and the black parts of the plumage are of a deeper tint. This, which is stated as peculiar to the Lesser Guillemot and Black-billed Auk, is exactly the winter-plumage of the young of the others. The old ones also assume the same appearance, still retaining the slight difference of a fainter shade of black on the upper part of the body. The specimen of young Guillemot, caught by MONTAGU in June, exhibits distinctly the young of the *preceding* autumn, passing into the plumage of the adult; and the winter-plumage of the Razor-Bill, as stated by FABRICIUS, is the same as that of the Black-billed Auk. The Little Auk is admitted to change its plumage in winter, to become white on the throat and sides of the head,—while these parts are black in summer. This is exactly such a change as its congenerous bird the Razor-Bill is asserted to undergo.

If the Colymbus Troile and Alca Torda be distinct species from the others, and preserve their distinct appearance, how happens it that we never meet with them in winter?

Though it were granted that they migrate, yet a few ought occasionally to be seen during winter. The fact stated by MONTAGU, of a few Guillemots, in their usual plumage, being found in the end of January on the coast of England, is merely an instance of the old birds acquiring the summer-plumage sooner than the young ones; and, moreover, this is confessed by MONTAGU to be “a *single* instance:” besides, if it were necessary, it might still be reasonably supposed, without receiving his conclusion from this fact, that these individuals had assumed their summer plumage earlier than is the general habit of the species; and this is an irregularity not unfrequent in other birds, and which may often result from their not having paired the preceding year; their moulting, and winter change may thus have been less complete; for I have certainly remarked, that incubation renders the moulting succeeding it more severe, and the change of plumage more marked.

If the *Colymbus Minor* and *Alca Pica* be distinct species, Why are we not acquainted with their young?—or, Are the young always the same in appearance as the old? This is, however, contrary to the analogy of all water-fowl in our latitudes, and especially to that of the other species of this genera.

The Black-billed Auks are said to occur more numerous-ly in Greenland than the Razor-Bill; but FABRICIUS, whom MONTAGU quotes for this fact, expressly says, he never saw the Razor-Bills there during summer,—it applies to the winter season; and the winter-plumage of the Razor-Bill, according to his description, is the same as that of the other. If then, as he admits, the sulcæ in the bill are no specific distinction,—how could he distinguish these two species from each other? It is sufficiently suspicious that he should never have seen the Razor-Bills in summer, when they are comparatively numerous in winter; but it

is easy to account for this, when he informs us, that the plumage of the Black-billed Auk in summer is just that of the Razor-Bill at the same season. It is farther remarkable, that while FABRICIUS gives minute details regarding the Razor-Bill in summer, a bird he declares he had never seen in Greenland during that season, he should say comparatively so little of the Pica at the same season, a species he mentions having seen at all periods of the year. He also states, that the Razor-Bill lays two eggs; and every other naturalist, including MONTAGU himself, mentions only one; and my observation agrees with this. And he asserts that the weight of the Black-billed Auk is *superior* to that of the Razor-Bill; yet he maintains the same opinion as MONTAGU, of the distinction of these two species. These remarks shew the contradictions into which this author has been led; and that, though his authority is highly respectable in many other points of Arctic zoology, in this it must be received with limitation.

If they be the same species, MONTAGU conceives they must moult four times a-year, since four different states of plumage may be remarked; but this inference is not at all necessary. These different states are accounted for by supposing, what is the fact, and what is acknowledged to be so, that they moult partially twice a-year; and that the other changes of plumage are acquired, not by new feathers, but by the change of colour of the old ones. Of facts exemplifying this change of colour in the old feathers, every practical naturalist has ample opportunities of satisfying himself; and for farther information on this point, I have only to refer to a very useful and interesting work, "The Philosophy of Zoology," by a most intelligent and zealous naturalist, Dr FLEMING, whose opinion respecting these disputed species I am happy to find is the same as my own.

MONTAGU refers the disappearance from the British coasts during winter of the Razor-Bills and Foolish Guillemots to migration; but this is a cause that has been much too generally applied to account for the apparent absence of many species in certain countries; it may be often accounted for by supposing them to change their plumage, or merely to disperse, when not induced by incubation to keep to certain haunts, and in numerous assemblages.

FABRICIUS says, that the Razor-Bills and Black-billed Auks breed in Greenland, and are found there during the winter; but MONTAGU states, that the Razor-Bills, not being so hardy as the others, migrate from the British coasts in winter, and their place is taken by the others. How, then, does it happen that the tribe of Razor-Bills in Greenland are so much superior in hardihood to their effeminate race on our coasts, and are able to brave the rigours of the frozen regions, when so many of the Black-billed Auks even are compelled to quit them? Or, if some migrate southward, how comes it to pass that they are never seen on the British coasts? The Black-billed Auks are very far from being so numerous in Zetland as in Scotland,—perhaps not much more frequent in that country than in England,—yet if such multitudes came from Arctic countries, we ought occasionally to observe them there on their passage southward, as happens with other birds, which visit it as a half-way station.

Not a single Lesser Guillemot or Black-billed Auk is seen on the coasts, even of Zetland, for six weeks after the alleged migration of the other species. This is decidedly opposed to all my observations. I have met with them from the period at which the Razor-Bills and Foolish Guillemots are first observed to quit the cliffs (in August), throughout the winter, till the middle of the ensuing spring. If they be not the same species, how shall we account

for this circumstance, that they are uniformly found in Zetland a month or six weeks before any other Arctic birds make their appearance? Many of them are also then in a state of moulting, and incapable of flying; others have their osseous system almost cartilaginous,—their sexual organs imperfect, proving them to be young birds, and therefore also equally incapable of flying. All this could not have happened if they had had so distant and stormy a migration to have effected.

There are no Lesser Guillemots or Black-billed Auks to be found in Zetland in summer. Those met with in winter are regarded by the fishermen as the same species as the others. Their habits are said to be different. It is mentioned that the Lesser Guillemots and Black-billed Auks are found in great numbers on the coast of Scotland during the winter, while very few are found on the coast of England; and in neither country a single individual of the other two species is to be found, though vast numbers breed in England. To migrate northward in winter is conceived to be unnatural and inconsistent, and, it is presumed equally so, to suppose the young birds to be different in their habits from the parent birds. If the old and young present the same plumage in winter, then there is no necessity for supposing that the former migrate; and the objection of distinction of habits does not exist: but, besides, difference of habits is not a specific mark in many instances; it of course constitutes an important feature in specific distinction; but then it is *permanent* difference, not that of season or age, or insulated from other circumstances. Many birds of the same species are very different both in plumage and habits in the young and adult state, and many species modify their habits according to locality.

The Black-backed Gull, for instance, feeds on fish and carrion alone in some countries; in others, he mimics the

Eagle, and treats himself to birds and young lambs! The Cormorant, in some situations, perches on trees, while, for the most part, he rests only on rocks by the water-side.

The Hooded Crow, in maritime situations, forgets his characteristic timidity for the water, and skims along its surface like a Gull in pursuit of small sea animals, though, as I have sometimes witnessed, he occasionally suffers from his aquatic excursions. I believe one of the most characteristic marks of distinction of species of birds is to be found in their modes of flight; it at least furnishes a good generic distinction. And to those who are in the practice of observing the habits of birds, this difference of flight is very striking: no one is more aware of this than the expert sportsman, for much of his success depends on this knowledge.

The reason of these birds accumulating in Scotland in winter, and not in England, is quite apparent; the deep bays and friths of the former afford them food and shelter, which the exposed coasts of the latter cannot confer. It cannot be mere climate; for there is surely not so great a difference between the winter temperatures of these countries, as in proportion to the greatly superior numbers that are found in Scotland at that period of the year. It is accordingly in the Frith of Forth and the Moray Frith in the east, and the corresponding lochs in the west, that they are chiefly found, while they are comparatively rare on the intermediate exposed coasts. The supposition, therefore, that they should migrate northward to a short distance in the winter, is not in "violation of the actual cause of the propensity to migrate."

The Foolish Guillemot and Razor-Bill produce each one young one in the year. The young, till about a week old, are covered by a dusky-grey down; and the first colour of the feathers is that of the parent-bird. Previous

to quitting the cliffs, about the middle of August, they have attained about one-half the size of the old ones: at this period the plumage is changed, the under part of the neck and sides of the head having become white. This is the state of plumage in which they have been described as distinct species, and they preserve it during the winter. In December they have attained the size of the adult birds. To assure myself of their changes, I kept several individuals tame till they were able to fly, and thus distinctly traced them. On the approach of spring, they may be seen passing into the summer-plumage of the mature birds. These also change in winter, turning white on the lower part of the neck and sides of the head; but, in the earlier part of this season, they may be distinguished from the young, by their greater size, and the less vivid black of the plumage. In the old Razor-Bill, also, the bill is larger, and more furrowed. In the adult Guillemot, the bill is considerably longer. As the season advances these distinctions become less apparent; but the old birds acquire their summer-plumage earlier in spring than the young.

There appears, therefore, no reason for separating the *Colymbus Minor* and *Alca Pica* from the Foolish Guillemot and Razor-Bill; and hence two species are expunged from the list. In the discussion which has led me to this result, I have been necessarily minute; but I have hardly been more so than the very ingenious and respectable ornithologist from whom principally I have differed. The opinion I have supported is not a new one, but has been held by many naturalists, who have, however, chiefly contented themselves with its mere statement, without satisfying their readers with an exposition of their reasons for it. This I conceived it to be useful to supply, especially as the advocate for the opposite opinion had displayed so much elaborate ingenuity in maintaining it. The discus-

sion may also not be useless, in illustrating some of those sources of error and precipitancy of observation, which have so much obstructed the advancement of zoology. If species so much in our way have been so long erroneously known, it is not surprising that others less numerous and accessible should be also so. The great influence, too, of MONTAGU, in questions of British Ornithology, required that the few errors into which he had been unconsciously led by partial observation should be fully understood.

The habits of the Razor-Bill and Guillemot are similar, and very interesting; they are gregarious, more or less, all the year round. They occupy the same kind of cliffs during the breeding-season, though the two species do not indiscriminately mingle on the same rock. They select long parallel ledges in the precipices about half-way from their summits, where they may be seen in large flocks, sitting close together, and ranged above each other in regular rows; their white breasts, black heads, and erect forms, giving them a peculiar and orderly appearance.

They live in the most cordial harmony with each other, and display uncommon affection for their young. These are taken to sea long before they seem capable of flying, and when their wings can be employed chiefly in assisting their motions under water. The fishermen assert, that the old birds carry them on their backs to the sea; but this seems unnecessary. I have seen some quit the rock for the first time; they were not one-third of the size of the adult birds; and all that the wings seemed able to effect, was a kind of balancing motion, to weaken their fall in the water. When they reached it, they immediately dived, and, although visiting it only for the first time, swam well, and kept long under it; and some even dexterously eluded, after the manner of their species, shots fired at them, by diving on the flash of the pau. The parent-birds were near,

and anxiously endeavouring to allure them from our reach. After the old ones have brought the young to sea, they almost immediately leave the land, and both young and old are then found in great numbers several miles off. The object of thus hurrying out to sea, seems to be to remove their young from their more numerous enemies, and to place themselves in comparative safety in commencing the process of moulting. This is very complete, or at least leaves them during part of its progress without the power of flight, the old feathers being generally cast before the new are sufficiently long for this purpose. The Velvet Ducks in North America are annually killed in great numbers during the moulting process, when they are incapable of flying; and the Auks and Guillemots would experience similar havoc, if instinct did not teach them to withdraw from the reach of their more formidable pursuers. After an absence of two or three weeks, they again approach the coast, and are found occasionally in parties of three or four individuals.

The young are easily tamed, but I think rather difficult to rear. They display an unaccountable restlessness towards evening, incessantly moving about, and uttering a plaintive, piping sound. They do not seem to be able to exist long in situations where they have not the opportunity of diving, and this, perhaps, is the reason of their going so early to sea. The fact, at all events, seems certain, however difficult it may be to assign a physiological reason for it.

The thorax is very much elongated, and capable of great distension. The circulating system is much developed; the heart and primary red vessels peculiarly capacious. The blood seems in greater quantity, and its colour is deeper than in land-birds,—a fact I have remarked in most diving animals. The tenaciousness of life is very remark-

able. Two old Guillemots were confined in a cage for a fortnight, in endeavouring to domesticate them : during the whole time they obstinately refused all food ; and when I released them to their native element, they seemed little changed, but in weight. One was a little weaker than the other ; and it was interesting to observe the care and tenderness with which it was regarded by its more vigorous companion : when it was unable to keep up with him, he would occasionally turn back, swimming round it, and apparently encouraging it by sounds and gestures to proceed beyond the reach of danger.

They are often observed to swim long after being shot through the heart : if the lungs, however, are wounded, they are unable to continue under water. The more speedy way of depriving them of sensation and life is by a sudden and violent concussion of the whole body.

It seems almost impossible to tame the old birds ; indeed this is no unusual case, where birds naturally familiar in the wild state, or easy of domestication in the young, are incapable of it when in the old.

From their breeding, for the most part, in situations of tolerably easy access, so much devastation is annually committed by the fishermen among old birds, eggs, and young, that their number seems progressively diminishing ; and it is to be regretted that the proprietors do not exert themselves to limit this abuse. It is not as it was formerly in Zetland, and still is in some remote islands, when sea-fowl constituted a regular and necessary article of subsistence. The fishermen never trust to them for this use, and the most experienced and adventurous climbers are often the most indigent ; besides, it is only the inhabitants of a few districts, that, from their vicinity to the haunts of sea-fowl, can practise their annual depredations, and they are observed to be certainly not more substantial than their

neighbours. The practice encourages irregular, rapacious, and dangerous habits, for fatal accidents are not unfrequently occurring to the fowlers: and checking its excess, would be repelling no romantic notions of liberty and attachment to country, associated with the chace, in minds alive to the refined pleasure of sublime scenery; for it is not the love of the chace, but its supposed subserviency to their emolument or taste, that induces them to pursue it.

It has been observed, that, around grazing islands, and situations where sea-birds were formerly numerous, fish were also very abundant; and that the diminution of both keeps pace in some degree with each other, although fishing is not now more generally practised than before. Causes for this result it might not be difficult to assign. Besides, water-birds, by scattering migratory fish, as the herring, tend to render them more stationary and permanent in countries through which they might merely pass.

Many of these species, also, in defence of their nests, prevent the more powerful rapacious birds from approaching near them, and thus are indirectly the protectors of the flocks that pasture in their vicinity.

Proprietors seem not sufficiently aware of these advantages, or of the inexpressible interest and ornament which the feathered inhabitants throw over the rocky scene.

EDINBURGH, }
March 24. 1823. }

III.—*Observations on the Anatomy of the Duck-billed Animal of New South Wales, the Ornithorynchus paradoxus of Naturalists.*

By ROBERT KNOX, M. D.

Member of the Wernerian Natural History Society, and
of the Medico-Chirurgical Society of Edinburgh.

(Read 17th May 1823.)

MEMOIR I.

*On the Organs of Sense, and on the Anatomy of the
Poison-Gland and Spur.*

IT will not be expected that, after the numerous dissections of the Ornithorynchus, performed in England, Germany, and France, by the most distinguished living anatomists, any very remarkable facts should have escaped notice. I am anxious that this should be borne in mind, for there are many who, viewing the Ornithorynchus as an excessively rare animal, might suppose every fact brought forward to be new, and censure the want of details, which could be useful only in the description of an animal hitherto altogether unknown. Now, this is far from being the case with the subject of the present memoir; for, at least one specimen has been anatomized in Germany, by Professor BLUMENBACH; one in Prussia, by M. RUDOLPHI; several

in France by the very celebrated author of the *Leçons d'Anatomie comparée*, and by others; and about ten specimens, in the best state of preservation, in London.

Professor JAMESON, who did me the honour to entrust the dissection to me, encouraged me to proceed in carefully noting the details, because, though nothing novel should present itself, the investigation might still prove useful, by confirming the discoveries of others. We were also aware that the descriptions of the most celebrated anatomists were completely at variance with each other, and with those of naturalists, relative to the anatomy of some very important organs; and that, consequently, the physiology of these organs must remain doubtful and conjectural, until the cause of these differences should be satisfactorily explained. I have only farther to mention, that as it was necessary to respect the skeleton, which is intended for the Museum, I did not consider myself at liberty to attempt any very minute dissections of the nerves, organs of sense, ligaments of the joints, and soft parts situated in the bottom of the neck and upper part of the thorax, which were otherwise required to render the observations complete.

It is well known that the specimens of this very extraordinary animal first brought to Europe were considered by many as impositions. They reached England by vessels which had navigated the Indian seas, a circumstance in itself sufficient to rouse the suspicions of the scientific naturalist, aware of the monstrous impostures which the artful Chinese had so frequently practised on European adventurers; in short, the scientific felt inclined to class this rare production of nature with eastern mermaids and other works of art; but these conjectures were immediately disproved by an appeal to anatomy.

As the animal became better known, attempts were made by naturalists to arrange it with the Mammalia, to which

grand division of the animal kingdom it evidently belonged; and, accordingly, in the Manuel of M. BLUMENBACH, we find it classed with the Beaver, Seal, Lamantin, &c. In the “*Regne Animal*,” the Ornithorynchus is better arranged with the *Edentata*, and is placed last. Two species are mentioned, one with reddish, smooth and slender hair, the *Ornithorynchus paradoxus* of BLUMENBACH; the other characterised by dark-brown hair (*brun-noiratre*), flattened and crisped*. M. CUVIER conjectures that these may be but a variety from age; but I have observed, that all the dried specimens preserved in the Museum belong to the first species,—whilst the two animals lately imported, and of which I dissected one, belong decidedly to the second. These different species may be distinguished, not merely by the colour and texture of the hair, but also by the shape of the tail, which, in the latter, altogether resembles that of the beaver, as well in external appearance as in internal structure.

The specimen dissected measured $16\frac{1}{2}$ inches from the end of the upper bill to the extremity of the tail; from the edge of the cloaca to the extremity of the tail measured about four inches.

The Ornithorynchus and Echidna (an animal closely allied to the former) are oviparous †. As they have no mammæ, they are without the grand characteristic mark of the first class of animated beings. Already naturalists begin to think, that animals differing so remarkably from the Mammalia, cannot with propriety be arranged with them.

The skin being the part to which naturalists chiefly direct their attention, has been sufficiently well described.

* Voyag. de PERON, I. pl. xxxiv. The drawings of the Ornithorynchus in PERON'S Works are ill-executed, judging by the specimen now before me.

† HOME, Phil. Trans.

The palmated feet, and membrane extending beyond the toes of the anterior extremity; the remarkable peculiarity of the bill, resembling so closely that of the duck, and to which an almost incredible number of nerves are distributed by all the great divisions of the fifth pair of cerebral nerves; the peculiarity of the hair, which is of two sorts, one sort fine and jointed, found on most parts of the body, but chiefly on the sides and abdomen,—the other bristly, flat, and shaped like the head of a spear, and which is found chiefly on the back and tail; all these facts, I believe, have been already noticed. The beaver-like tail of the animal is covered with short hairs of the spear-pointed form; these more resemble bristles than hairs. The skin is thick and compact; and a powerful *panniculus carnosus* extends over the whole body, the feet, tail, and bill, being of course excepted. Some very distinct muscular slips arise from the *panniculus carnosus*; the most remarkable are, 1st, The *platysma myoides*, or *dermo-clavicular*, arising near the angle of the jaw, and proceeding downwards to be inserted into the aponeurosis covering the horizontal branch of the clavicle; 2d, The *dermo-humeral*, a strong muscular slip, arising from the *panniculus carnosus*, lying over the lower ribs, and following the course of the pectoral muscles, is inserted into the os humeri, tendinous in common with the above muscles; 3d, The *dermo-tibial*, a strong slip, which joins the caudo-tibial, and has a common insertion with it; *lastly*, Two very strong muscular expansions, arising from the skin of the back, and loins, and converging like the radii of a circle towards its centre, are inserted into the root and sides of the tail, and into the transverse processes of several caudal vertebræ: these are elevators of the tail, and may be called *dermo-caudal*. The action of the others does not require any particular notice. These are the chief peculiarities of the *panniculus*

carneus in the *Ornithorynchus paradoxus*: under the skin of the tail it degenerates mostly into a cellular tissue, in which is deposited a dark-yellow fatty matter. We may readily imagine the great powers possessed by this, the most extensive muscle of the body, over the viscera contained within it; and how, being only a little increased in the *Echidna*, this latter should thereby be enabled to roll itself up into the form of a ball, after the manner of the common hedge-hog.

The skin and subcutaneous cellular tissue abounded so much with oil, as to render this part of the dissection unpleasant; the cellular tissue betwixt the *panniculus carneus* and subjacent muscles was coarse, and in many places assumed the form of semitendinous fasciæ. The skin extending beyond the toes of the anterior extremity contains within its substance five narrow longitudinal horny processes, resembling that which is found within the integuments of the upper mandible; the two innermost toes of the hind feet are likewise characterized by a process of the skin extending beyond the nails. I shall consider the bill of the *Ornithorynchus* as the organ of touch, by means of which the animal searches for its food; the supply of nerves is such as to render it the most perfect instrument of the kind with which we are acquainted. The length of the upper mandible, including the flap, is three inches nearly; that of the lower bill, and flap, only two.

The organs of taste and smell will not detain us long: the latter organ, indeed, could not be properly examined, as I was not at liberty to injure the bones of the face; it is probably not very energetic. The nostrils open anteriorly near the point of the upper mandible; the anatomy of the posterior nares is regular, as in the *Mammalia*. The tongue has already been sufficiently well described by authors; it is covered with a thick cuticle, and cannot be considered

as possessing much sensibility; it seemed to me that the gustatory branch of the fifth was comparatively very small, but the hypoglossal nerves were large, and proportioned to the development of the strong muscles connected with, or entering into, the composition of the tongue. It is sufficiently curious, that the muscular apparatus supplying the tongue of the Ornithorynchus should much resemble that with which animals having a highly extensile tongue are furnished; yet, in the former, the lower surface of the tongue is so secured as to render extensive motions of this organ impossible. The tongue is fleshy and thick: at about $\frac{8}{10}$ ths of an inch from its base, or $1\frac{2}{10}$ ths of an inch from its point, are inserted the lingual teeth, which, like the other teeth of the animal, are entirely cuticular, and may be removed by maceration along with the cuticle. I shall return to this subject when speaking of the organs subservient to digestion. The palate is marked by several transverse folds: deep notched indentations run along the sides of the lower bill, from its angle nearly to the point; those of the upper bill are found only near the angle of the mouth. These reduplications of the membrane of the bill might be supposed to increase the sentient surface; but it seemed to me that the nerves did not proceed to them in such abundance as to the anterior portions of the bill. I should consider, then, these folds as intended merely to allow the mandibles to close very accurately, and thus to prevent the escape of those smaller insects on which probably the animal feeds.

Though the actual organ of hearing did not come under my observation, still there presented themselves several appearances relative to those appendages, placed between it and the external air, which merit the attention of the Society. There is no external ear, or rather there is no ear externally; for although there be no cartilaginous projec-

tion exterior to the integuments, yet a tolerably perfect concha exists immediately beneath them. The longitudinal aperture by which the ear opens on the integuments is situated immediately behind the eye, and not far from the posterior or floating edge of the flap of the bill. The hairs are disposed around this aperture, as the feathers around the ear in birds. There is nothing peculiar in the aperture itself as to muscles, &c., but it opens immediately into a considerable cavity, formed by a cartilaginous plate, disposed after the manner of the concha of the Mammalia, and which we must consider as the true external ear of the animal, though it be not external to the integuments. The cartilaginous plate is fixed, on the one hand, to the long tube, connecting it with the cavity of the tympanum, and, on the other, in a very loose manner, to the superjacent integuments. Distinct muscles are attached to it, as in the Mammalia, which have the concha situated externally. These arise from the *panniculus carnosus*, and are inserted into the concha: there can be little doubt, that, by their action, and the loose attachment of the cartilage of the ear to the integuments, considerable motions are performed by it,—the object of which must be to increase the general cavity formed by the concha, and cartilaginous tube of the ear, and in some measure to increase the size of the external aperture. Nearly one half of the external opening of the ear is formed by the edge of the cartilaginous tube; the common integuments form the remaining half, because the cartilage properly called Concha is thrown back under the integuments, having an extensive margin attached slightly by cellular tissue to the integuments, completing, in this way, the circle of the meatus externus. We thus see that there is a certain degree of inaccuracy in stating that the Ornithorynchus has no external ear; and that it should be said that it has no ear externally, since a tolerably

perfect external ear exists immediately beneath the integuments. It is extremely probable that a similar distribution of these parts may exist in some other animals described as being without external ears.

We may now proceed from without inwards towards the internal ear, and briefly sum up the anatomy of the whole, as far as a respect for the skeleton permitted me to investigate. There is, first, the external opening, which had been mistaken for the simple termination of the cartilaginous tube of the ear, but which we have demonstrated to be the opening of the concha, that part of the cartilage which, in other animals, is in part detached from the head to form a true external ear, being in this animal concealed by the integuments, but in such a way as not to impede its functions. I need hardly mention, that the concha was situated at the side of the opening farthest removed from the cranium. From the cartilage of the concha arises a remarkably long cartilaginous tube, proceeding from the upper part of the head, close to the eyes, over the lower jaw, as far as the base of the cranium; it measures in length $1\frac{6}{10}$ ths of an inch, and nearly $\frac{4}{10}$ ths in breadth, when opened. The texture of the middle tunic is not quite cartilaginous; it terminates at the root of the styloid process, and opens wide into the cavity of the tympanum. Near its termination in the tympanic cavity, a few projecting points, on its inner surface, mark the probable existence of small cartilaginous bodies. The Eustachian tube is entirely cartilaginous, and is not inclosed in any osseous case; this is owing to a deficiency of a great part of the osseous circle constituting the frame of the *membrana tympani*. Now, in consequence of this deficiency, the anatomy of these parts is somewhat peculiar; for, in addition to the Eustachian tube being simply cartilaginous, and not inclosed in any osseous case, (which, so far as I know, is peculiar to this animal), the

ossicula of the ear are much exposed, and the tympanic cavity has a great portion of its parietes composed of soft parts, or, in other words, is placed in a great measure external to the cranium. The anterior part of the malleus is strongly attached to the extremities of the pterygoid processes of the sphenoid bone. The stapes is composed of a single stalk and circular plate, by which it is inserted into the vestibular foramen of the internal ear, the foramen being itself also circular. The form of the stapes appeared to me to be that in which the ear differed most from that of the Mammalia, and even approached reptiles and birds; and had nature preserved the same form of stapes throughout the whole class of Mammalia, we might have noticed the stapes in the Ornithorynchus as a wonderful peculiarity. But this is not the case, for, in the Cetacea, the stapes differs from all other mammiferous animals; it does not indeed resemble that of the Ornithorynchus; but it is sufficient for our present purpose, that it differs essentially from that type which nature has so extensively observed. "Instead of the two branches," observes CUVIER, "the Cetacea have a solid body, compressed conically, and perforated by only a very small foramen." In the Ornithorynchus this perforation is wanting, (though it be present in some birds, as in the Owl); and the slender stalk and circular plate of the stapes bear the closest resemblance to the analogous ossiculum in birds and reptiles. Between the external ossiculum, or that connected with the membrana tympani, and which bears a close resemblance to the malleus in many of the Mammalia, and the stapes, there exists an irregular triangular-shaped bone, evidently analogous to the incus. It is true, that this bone may, in the Ornithorynchus, be merely a process of the malleus; but I am by no means of this opinion, for the following reasons: 1st, It is most readily detached from the malleus; 2dly, It has a consider-

able resemblance to the incus of the Mammalia, and has precisely the same situation; *lastly*, The vertical direction in which it is placed, shows that it cannot be a process of the malleus. In thus reducing the ossicula of the ear to an analogy with those of the Mammalia, I am not unwilling to admit, that there are certain points of resemblance with those of reptiles and birds, more particularly in the semi-cartilaginous state of the bones themselves, in the exposed situation of the cavity of the tympanum, in the very peculiar form of the stapes; but it must be evident, I think, to all, that certain of these deviations from the usual structure arise out of the deficiency in the osseous parietes of the tympanic cavity, and consequent attachment of the small bones of the ear, and the membrana tympani itself, to a portion of the pterygoid processes. On the other hand, the internal aspect of the cavity of the tympanum appears quite regular; the vestibular foramen, that which in Man, by a faulty nomenclature, is called oval, is in the Ornithorynchus perfectly circular. An attempt is made, by a projection of the bones, to divide the tympanum into two cavities, in one of which is situated the *ossicula auditus*, and the vestibular opening. By the wide opening into the other cavity passes the facial nerve, which escapes from the cavity by a hole close to the cochlear opening of the internal ear; this latter is much larger than the vestibular. The principal branch arising from the superior cervical ganglion passes along the roof of the tympanum, and internally with regard to the stapes, on its way to join the fifth pair of cerebral nerves.

It will be readily understood that the cavity of the tympanum, which is inclosed partly by osseous, and partly by cartilaginous parietes, is considerable. Its anterior portion may be divided into two principal cavities, viz. that which contains the ossicula and vestibular foramen, and that

which extends upwards under a portion of the temporal bone, forming the glenoid cavity, and consequently extending towards the zygomatic arch. The posterior cavity, whose parietes are in like manner partly osseous and partly cartilaginous, contains the cochlear opening, and a part of the facial nerve in its passage outwards. A strong osseous plate, proceeding from the temporal bone to the base of the styloid process, is that which chiefly divides the anterior and posterior cavities from each other; but as the parietes of this second cavity of the tympanum are cartilaginous on one aspect, viz. the lower, the foramen by which the facial nerve escapes from the cranium is not completely osseous, but has about a third of its circle composed of cartilage. I shall conclude this sketch of the organ of hearing of the *Ornithorynchus*, by observing, that in no part of the anatomy of this animal have I found a greater deviation from the strictly mammiferous structure, as in the formation of the tympanic cavity, and in the small bones contained within it.

The position of the eyes in the upper and anterior part of the head, close to the edge of the flap, has been already noticed. The eye-balls are small, and placed deep in the orbits; they seemed to me quite regular, both as to internal structure, and to the muscular and nervous parts situated externally to the eye-ball. I could not perceive very distinctly any lachrymal gland, though anteriorly there is a small duct, which would seem to lead into the cavity of the nose, and, if real, may be considered as analogous to the lachrymal duct in the *Mammalia*. The convexity of the cornea belonged to a sphere not much smaller than the sclerotic; the lens is flat and soft; the orbit incomplete. Owing to the long immersion in spirits the internal structure of the eye-ball could not be distinctly made out, and

it would be tedious to describe its external muscles, which, so far as I could judge, did not differ greatly from those of the Mammalia*.

2. *On the Poison-Gland and Spur.*

It seldom happens that Nature leaves animals unprovided with means of defence against their enemies, and she has furnished the *Ornithorynchus Paradoxus* with one of the most extraordinary which probably exists. The comparative anatomists, as well of the Continent as of England, who first examined this animal, viewed the spurs as connected with the organs of generation: they were evidently peculiar to the male; and it was conjectured by Sir E. HOME, and by the celebrated CUVIER, that they were merely accessory organs, and were accordingly classed with the organs of prehension. They are thus described in the *Anatome Comparée*: “L’ergot de l’Ornithorinque et de l’Echidné est composé de deux osselets ou de deux phalanges, dont l’une tres court, aplatie, s’articuli sur une facette de l’astragale, située du cote interne et inferieur de cet os, et l’autre orgueale plus longue, de figure conique, sert de moule à la corne qui forme l’ergot. Cette corne est pointue, assez longue, fixée du coté interne de l’articulation du pied, ayant sa pointe dirigée en dedans.”—Tom. v. p. 116.

A similar opinion was formed of the use of these spurs by most French and German anatomists. Some years after, a brief notice found its way to this country of severe cases of poisoning having followed a wound made by the spur of the *Ornithorynchus*. In consequence of this notice, the attention of anatomists was roused, and a specimen examined by Dr DE BLAINVILLE, and one by Professor

* I thought I noticed a third eye-lid, though very small,

RUDOLPHI, with a view to discover the poison apparatus, if any existed. The known excellency of these distinguished naturalists, as comparative anatomists, induces me to think that the specimens examined by them must have been extremely mutilated, for their descriptions bear no resemblance to the true anatomy of the poison-gland and spur.

On the heel of each of the hind feet there appears externally a spur, much resembling that found in the common dunghill-cock. It is strong, semitransparent, and pointed; and there is evidently an aperture at the point, or rather on its convex surface, and sloped, as if a small piece had been cut out of it, without shortening the spur. Through this, a delicate black body, like a bristle, projects; it seems of a horny consistence; though a strong magnifying glass was used, it did not appear to be hollow. On removing the integuments carefully, the spur is found to rest by its base on a flat bone, placed longitudinally over the tarsal bones, and situated between the lower extremity of the tibia (to which it is attached), and the tarsal bone corresponding to the inner toe. Its principal connection, however, is principally with the astragalus. In this way two joints are formed, viz. one between the bone on which the spur rests and the other bones of the tarsus, and the other between the spur itself and the bone. The motion in both these joints is inwards towards the tail, and this is the direction which the spur assumes, and the only one in which it can possibly wound. If a longitudinal section be made of the spur, it will be found to contain a comparatively large membranous canal, gradually increasing as we proceed towards the base; this membranous tube is contained in the centre of the spur, which immediately around it has a whiter appearance than the more external portions, but has no resemblance to bone, as some estimable authors have stated: it is merely a little firmer than the other parts

of the horn. As the membranous duct approaches the base of the spur, it becomes very strong, as if semicartilaginous tunics were superadded to it; just as it quits the spur to enter the sole of the foot, the duct makes a sudden turn, and is much contracted; it next expands a little, and at this point its parietes are so thick as to give it the appearance of a bulb or gland, an appearance which, together with the deep situation of the sac in the hollow of the foot, led M. DE BLAINVILLE to consider it as the poison-gland itself, and which evidently has been the cause of the very singular errors committed relative to the anatomy of the spur. When this bulb is laid open, it is found to be merely a continuation of the mucous canal, which has at this point become greatly strengthened in its parietes, and assumed an almost muscular appearance. In the hollow of the foot the duct opens by a sudden turn into a comparatively large sac, surrounded and inclosed by strong ligamentous and tendinous parts, connected with the small bones of the foot. From this sac or bag, which in either foot contained a good deal of a brownish, mucous matter, arises the great duct leading to the poison-gland. We may now trace this duct either from the sac towards the gland, or *vice versa*. If the first plan be adopted, we perceive that the duct enters the central sac by a small round orifice, and next makes a very sudden turn to reach the superficial part of the foot, and is soon found almost immediately under the integuments. From this point it proceeds towards the gland, gradually decreasing in strength of parietes, but increasing in diameter until it terminates, or rather commences in the poison-gland itself, situated over and somewhat above the hip-joint and loins. Throughout its course the duct lies imbedded in loose cellular membrane, and beneath the caudo-tibial muscle, which must be removed, in order to

have a perfect view of the duct*. It is rather difficult to state the precise length of the duct from its origin in the poison-gland to its passage into the small sac situated in the hollow of the foot; for about $1\frac{8}{10}$ ths of an inch its parietes are comparatively thin, and its diameter sufficient to admit a common blowpipe. The remainder of the duct, and the sudden turn it makes to pass down into the centre of the foot and to reach the sac, have been already described.

The poison-gland itself is about an inch in length, and $\frac{5}{10}$ ths of an inch in breadth. It is a conglomerate gland, that is, made up of smaller ones, imbedded in a tissue of a different appearance, and which is probably cellular. It lies longitudinally with respect to the spine, immediately above the hip-joint, and close to the os innominatum of the corresponding side. It advances but little towards the loins; it covers many of the muscles which rotate the thigh, and may readily be found by merely removing the integuments, panniculus carnosus, and a small quantity of loose cellular membrane lying over the os innominatum and hip-joint.

The functions of these parts may now be very readily understood. The poisonous fluid secreted by the gland is conveyed by the long duct into the sac situated deep in the hollow of the foot close to the heel. From this it is projected into the membranous canal contained in the centre of the spur, and which, by an almost inexplicable error, has hitherto been mistaken for a bone. Along this it will easily flow into the wound inflicted by the spur, passing through

* The whole anatomy of the Poison Gland and Duct, has been beautifully depicted by the artist I employed, Mr R. MACINNES; and the circumstance, that none of the artists employed had the least knowledge of the anatomy of the parts, will no doubt be deemed of considerable importance by many.





the small perforation existing, as well in the termination of the membranous canal, as in the spur itself. I am not prepared to say what may be the precise use of the small dark bristle-like body filling up, as it were, the extremity of the canal in the spur. It is not connected particularly with the membranous canal, but it must be evident that the poisonous fluid may find its way to the point of the spur by the sides of the horny substance alluded to. Fluids injected into the duct, near its commencement in the gland, pass into that contained within the spur, and even out of the extremity of the latter; and the pressure of a moderate column of quicksilver forced the metal to distil in excessively minute globules from the point of the spur.

The accompanying engraving (Plate I.) scarcely requires any explanation. On the upper and back part of the thigh and loins may be seen the large poison-gland and duct leading from it towards the bottom of the foot; a small steel-probe has been passed along the duct into the sac, in order to show the mode of its entrance into the latter; the bulb at the base of the spur, the membranous canal, and the spur itself, are all sufficiently distinct.

 IV.—TENTAMEN METHODI MUSCORUM;

OR,

*A New Arrangement of the Genera of Mosses,
with Characters, and Observations on their
Distribution, History, and Structure.*

By R. K. GREVILLE, Esq. F. R. S. E. M. W. S. &c.

AND

G. A. WALKER ARNOTT, Esq. A. M. F. R. S. E. M. W. S.

(Continued from Vol. IV. p. 150.)

(Read 26th April 1823.)

 MEMOIR II.
GYMNOSTOMOIDEÆ, *Gen.* (5—8.)

CHAR. CALYPTRA aut dimidiata aut mitræformis. Seta terminalis vel lateralis, longitudine et colore valde varians. Theca integra, sæpius æqualis, sed quandoque angulata. Operculum deciduum. Peristomium nullum.

CHAR. Calyptra either dimidiate or mitriform. Seta terminal or lateral, varying much in length and colour. Theca entire, generally equal, sometimes, however, angular. Operculum deciduous, and leaving beneath it no trace of a peristome.

Obs. To this tribe belong all HEDWIG'S *Gymnostomii* (excepting *Sphagnum*), and PALISSOT'S section of "*Les Apogones urne tubulée*," with the exception of *Tetraphis*, which that author unfortunately supposed to be destitute of teeth; not having seen the true operculum, he mistook the peristome for that part,—“se divisant en quatre portions egales dentiformes permanentes.”



GEN. V. GYMNSTOMUM, *Hedw. Schreb.*

FRUCT. *Calyptra* dimidiata, magna, vel thecæ appressa vel inflata, et tunc interdum 4-angulo-pyramidata, persistens et maturitate medio latere rumpens sic pseudo-mitræformis. *Seta* terminalis innovatione quandoque quasi lateralis, plerumque foliis perichætialibus multo longior, thecæ subconcolor, rigida, stricta aut flexuosa, in una tamen specie pallida, crassa, carnosâ. *Apophysis* raro ulla? *Theca* integra subglobosa hemisphærica, turbinata, ovata, oblonga, aut cylindræa, etiamve angulata æqualis, aut quandoque sic medio subconstricta ut quasi apophysata, in speciebus diversis varians, sed in eadem plerumque at non semper constans; ore interdum contracto sed sæpius amplo, nudo, in quibusdam tamen annulo gaudente, brunneo-fuscescens, lævis, striata vel sulcata. *Operculum* deciduum, thecæ concolor, obliquum, rostratum, conicum aut mammillatum in quibusdam acutum, in aliis obtusum, semper integrum. *Peristomium* nullum. *Columella* ætate plerumque theca brevior, interdum longior et operculo adnatum, sæpius filiformis vel subclavata, stricta, rarius ampla, obconica vel potius infundibuliformis. *Sporula* valde variantes.

CHAR. DIFF. *Calyptra* dimidiata. *Seta* terminalis. *Theca* ore nudo.

FRUCT. *Calyptra* dimidiate, large, either closely embracing the theca, or inflated, and then sometimes quadrangular and pyramidal, persistent, and, in consequence of a lateral fissure, which then takes place midway between the base and the apex, becoming eventually pseudo-mitriform. *Seta* terminal, but sometimes apparently lateral from innovations; generally much longer than the perichæatial leaves; similar in colour to the theca; rigid, straight, or flexuose; in one species, of a whitish colour, thick, and carnose. *Apophysis* rarely any? *Theca* entire, subglobose, hemispherical, turbinate, ovate, oblong or cylindrical, or even angular, equal, or sometimes so contracted in the middle as to appear furnished with an apophysis; varying in different species, but tolerably constant in the same; the orifice is sometimes contracted, but more frequently large, naked; in some instances furnished with an annulus, reddish-brown, smooth, striated or sulcated. *Operculum* deciduous, of the same colour as the theca, oblique, rostrate, conical or mammillose, acute or obtuse, always entire. *Peristomium* none. *Columella*, when mature, usually shorter than the theca, in some species, however, exerted, and even adnate with the operculum; mostly filiform or clavate, straight, rarely large, obconical, or rather infundibuliform. *Sporulæ* various.

DIFF. CHAR. *Calyptra* dimidiate. *Seta* terminal. *Mouth of the theca* naked.

VEG. The stems of the *Gymnostoma* are extremely variable in length. In some species there is scarcely any at all; in others they are longer, but still simple; while in several they are much elongated, and repeatedly branched. The former, as might be expected, grow either in a solitary or tufted manner; the latter closely matted and interwoven together. The leaves present a reticulation curiously

varied; that of *G. Griffithianum* being perhaps the most remarkable, and resembling concave *foveæ* or pits, rather than regular cellules. *G. ovatum* is worthy of notice, from its leaves having a mass of minute round gemmæ on their nerve and centre. In regard to form, the leaves differ considerably; in *G. Griffithianum* they are nearly round; in *G. ovatum* ovate, with a hair-point; in *G. microstomum* and *Donianum* subulate; and if *Drepanophyllum* of RICHARD, HOOKER *, and SCHWÆGRICHEN †, be added to the genus, they are sometimes falcate. They are also either acute or obtuse, entire, dentate or serrate, usually slightly concave; but in *G. involutum*, they are remarkably involute; and in *G. julaceum* convolute; their arrangement on the stem is in every instance imbricated; the doubtful *Drepanophyllum* alone having them inserted bifariouly. In none of the species are the cauline ones destitute of a nerve.

Obs. In this genus the two opposite extremities exhibit little in common; yet, with the exception of *Drepanophyllum*, the species may be said to form an uninterrupted series. Some bear a near affinity in general habit to other genera; as, for instance, *G. Griffithianum* to *Splachnum*, and *G. microstomum* to *Weissia*, &c.: such anomalies, however, must necessarily occur both in the embryonate and exembryonate tribes of vegetables. Of the above examples, however, *G. Griffithianum* is not in reality so closely allied to *Splachnum* as has been by some imagined; the reticulation of the leaves is of a very different nature, and the thick carnose seta is totally at variance with that genus.

* Musci Exotici, tab. 145.

† Sp. Musc. Supp. 2. tab. 125.

Drs HOOKER and TAYLOR have said (*Muscologia Britannica*), "A delicate horizontal annular membrane may be seen to arise within the mouth of the capsule of some species, when examined in a fresh state, as in *G. microstomum*, *G. fasciculare*, *G. truncatulum*, and, above all, in *G. Griffithianum*, in which, not unfrequently, this membrane is entire." And afterwards, "The membrane stretching across the mouth of the capsule is only to be seen in fresh specimens." Should this membrane in the latter moss be found hereafter to arise from the *stoma* (which, indeed, we very much doubt, but which, if it were the case, would bring this extraordinary plant under BROWN's character of *Hymenostomum*), and not to be a mere cover to the sporular sac, it would lead to the formation of a new genus. SCHWÆGRICHEN, indeed, in his Second Supplement to HEDWIG's *Species Muscorum*, has ventured to constitute of it a genus from such dried specimens, as in which he confesses he never saw the character: he has called it *Ædipodium*, and has separated it from *Gymnostomum*, because it has "peristomium nullum aut exigua membranula indivisa." Now, every moss possesses this "membranula indivisa," arising from the lining of the theca; but in all the species of *Gymnostomum*, it is peculiarly evident at some particular stage.

In our description of the fructification, we have noticed the columella, which, in some few species, is of a most remarkable form. Dr HOOKER has delineated a curious example in *G. Xanthocarpum*, and we have added that of *G. pyriforme* in one of the plates accompanying this paper. In the latter, if a specimen be taken before the fructification be quite mature, and the operculum with the opercular membrane be forcibly, but carefully detached, we perceive a membranaceous expansion, which, if the sporules be removed, resembles an inverted cone, the base or superior

portion of which, is attached all round to the sporular bag at the margin of the theca. That part of this membrane which unites the lining of the theca to what is usually called the summit of the columella, is in this genus commonly of a strong nature,—so much so, as to induce Mr BROWN, and also ourselves at one time, to conclude that *G. microstomum** possessed a horizontal membrane actually arising from the wall of the theca. This, however, is not the case: but even supposing it were so, the difficulty of examination is so great, and the membrane itself so evanescent, this character alone would be but of little use, though certainly sufficient to remove any plant from the true *Gymnostoma*.

With the membrane which covers the sporular bag, the peristome of *Leptostomum* must not be confounded. In that genus, Dr HOOKER remarks, that the peristome is very near that of *Diphyscium*; and we add, also, to the internal peristome of *Buxbaumia* and *Ptychostomum*, (HORNSCH.); but *Leptostomum* and *Ptychostomum* we think more naturally allied to *Bryum*.

We have already mentioned that some species possess an annulus. Dr HOOKER, in his “*Musci Exotici*,” has figured two, *G. julaceum* and *involutum*. WEBER and MOHR (Handbuch, p. 86.) first pointed out this part in *G. tenue*,—“*Arte solventes operculum, annulum s. fimbriam, cujus nec HEDW. nec SCHRAD. mentionem fecerunt, observavimus.*” This was soon afterwards also observed by RÖHLING. To these three must be added, *G. trichodes*

* Mr BROWN constitutes of this plant his genus *Hymenostomum*, with the character—“*Stoma edentulum, clausum epiphragmate (e membrana exteriore orto), disco tenuissimo (a columello libero) mox rupto et evanido; limbo persistente, horizontali indiviso.*”—Linn. Trans. v. 12. p. 572.

(WEBER and MOHR), the *Weissia trichodes* of HOOK. and TAYL., and *Grimmia trichodes* of SMITH, which we conceive to belong to this genus.

We shall conclude our observations, by noticing, that Sir JAMES EDWARD SMITH alludes to the Hyssop of SOLOMON being contained in this genus, and states it (according to the Linnean Herbarium) to be *G. fasciculare* *. WEBER and MOHR do not seem certain as to the species; and PALISSOT DE BEAUVOIS, without assigning any reason, changes it into a *Phascum*, as, when speaking of the Phasca, he observes, “ parmi lesquelles on croit reconnoître l’Hyssope de Salomon.” The last notice of this subject is to be found in Mr GRAY’S extraordinary work on British Plants, where he gravely adds, and with his usual brevity, the following *synonym*, under *Gymnostomum fasciculare*: “ *The hyssop that groweth on the wall.*—English Bible.”!

We shall only add to the above, conceiving the whole to be a matter of mere speculation, on which every one has a right to say what he pleases, and without much danger of refutation, that it is as probable that the hyssop may be neither a species of the genus *Hyssopus* nor of *Gymnostomum*. If we examine the New Testament, we shall perceive, that at the time of our Saviour’s crucifixion, when he thirsted, that they filled a sponge with vinegar, and placed it on *hyssop*, “ ὑσσώπῳ περιθεντές,” in order to extend it to him, (St John, ch. xix. v. 29.) Now, Matthew uses a different expression; he says, they put the sponge on a *reed*, “ και περιθεισ καλάμῳ,” (Matth. ch. xxvii. v. 48.) And Mark, (ch. xv. v. 36.,) confirms this, “ περιθεισ τε καλάμῳ.” From these authorities, one might infer, either, that hyssop was a reed, or, as καλάμος

* Fl. Brit. p. 1166. and Eng. Bot. t. 1245.

may be a wand, or slender branch of any kind, so ἵσσοπος is the bush or tree from which the twig was taken; but whichever be the reading, the hyssop of St John can neither be the herb known at this day under that name, nor any of the Musci. In interpreting rigorously the passage in 1. Kings, ch. iv. v. 33. we do not find any thing dissonant to this: "And he spake of *trees* (*lignis* in the Vulgate, and ξύλων in the Septuagint), from the cedar that is in Lebanon, even unto the hyssop that springeth out of the wall." But might not hyssop have been the name for *any* small plant, in contradistinction to the magnificent cedar*?

HAB. *Gymnostomum* is a genus widely distributed in every quarter of the globe, each claiming a greater or less number of species; temperate climates are, however, the most favourable to their production. Most of the species are found on the ground, some on rocks, and one only, that we are aware of, on trees (*G. viridissimum*). Those most rare

* As this subject has excited no small interest with many speculators, we shall add here the literal translations in Latin of the passage, taken from different Versions.

1. HEBREW—"Et locutus est super *lignis* a *cedro* quæ in Libano, et usque ad *hyssopum* quæ egrediens in pariete."
2. SYRIAC—"Disseruit etiam de *arboribus*, a *cedris* Lebani usque ad *sempervivum* quod prodit in pariete."
3. ARABIC—"Locutus est de *arboribus*, et exposuit virtutes earum; disseruit autem de quibuscunque *arboribus*, a *cedro* Libani usque ad *herbam* quæ nascitur in pariete."
4. GREEK—"Et locutus est de *lignis*, a *cedro* quæ est in Libano, et usque ad *hyssopum* egredientem per parietem."
5. VULGATE—"Et disputavit super *lignis*, a *cedro* quæ est in Libano, usque ad *hyssopum* quæ egreditur de pariete."

It will be remarked, that the Syriac and Arabic use a different phrase from hyssop. The Chaldee Version has not this passage at all, but a totally different one in its place.

in this country are, *G. Griffithianum*, *trichodes*, *conicum*, and *Donianum*. The first has been gathered on Ingleborough, Snowdon, and the mountains of Angushire; the second in Sussex, and near Dublin; the two last are abundant in the very few stations in which they are found. *G. conicum* is, according to Mr MACKAY, too frequent in the Dublin Botanic Garden; and *G. Donianum* we have recently had the pleasure of rediscovering, in the utmost profusion, in Mr DON's old and only station, the Den of Dupplin, Perthshire. Very few *Gymnostoma* are to be met with on elevated mountains, though many occur in subalpine districts.

HIST. The Mosses composing the present genus, formed with DILLENIUS and LINNÆUS a part of *Bryum*. At that period no attention was paid to the peristome; but as soon as HEDWIG commenced his work of reformation, the genus *Gymnostomum* was established: and at the same time was described another genus nearly allied to it, by the name of *Hedwigia*, the same as *Anictangium* of the *Species Muscorum*. In that work fifteen *Gymnostoma* are published, and seven *Anictangia*, from which must be deducted, as being varieties, or belonging to other genera, the following; from *Gymnostomum* five (of which one is *Schistostega*), and from *Anictangium* six species (of which one is a *Gymnostomum*, and another an *Hedwigia*). In the first Supplement published by SCHWÆGRICHEN, twenty-four species of the one, and ten of the other, are enumerated. BRIDEL in his last work gives us no fewer than four genera formed out of the above, *Gymnostomum*, *Pyramidula*, *Schistidium*, and *Anictangium*; of which, the first contains thirty species, the second one, the third six, and the last two: *Pyramidula*, however, is a true *Gymnostomum*, and ranks next to *G. pyriforme*, and of his two species of *Anictangium*, the

one is a variety of a *Gymnostomum*, and the other an *Orthotricum*. Upon the whole, there are scarcely more than twenty-nine or thirty true species known of *Gymnostomum*, including those described by Dr HOOKER in *Musc. Exot.*, (with the exception of Mr BROWN's *Leptostoma*, which we conceive to form an excellent genus). In Great Britain, Sir JAMES EDWARD SMITH enumerates sixteen species (*Fl. Brit.*); these he increases in his *Compendium* to twenty; but Drs HOOKER and TAYLOR, in their *Muscologia Britannica*, reduces them to fourteen.

There are a few plants which require to be noticed in this place, some of which have been denied to belong to this genus, and others improperly retained.

Ædipodium, the new genus constituted by SCHWÆGRICHEN, we have already mentioned. *Gymnostomum trichodes* has been described by HEDWIG as an *Anictangium*, by SMITH as a *Grimmia*, and as a *Weissia* by Drs HOOKER and TAYLOR. We are more inclined to follow WEBER and MOHR, and other authors, who deny it a peristome, than those who hold a contrary opinion. The authors of the *Muscologia Britannica* observe,—“The curious peristome of this plant, in an early stage, represents only a membranous ring, lying horizontally within the edge of the mouth of the capsule: this, however, as maturity advances, splits into sixteen equal, short, and very obtuse teeth, which become erect, and afterwards reflexed over the mouth of the capsule.” Sir J. E. SMITH, in *Eng. Bot. tab. 2563*, also remarks, “Mr BORRER observes, that the fringe seems a continuation of the inner coat of the capsule, and looks at first like a thin inflexed membrane, nearly closing the mouth; afterwards, when dry, it becomes reflexed, forming sixteen very short, blunt, flat, and pale teeth, and soon falls off.—Mr J. D. SOWERBY found each tooth divided by a line, transversely furrowed,

and occasionally emarginate *. Now, it should be observed, that these teeth, which are acknowledged to arise from the interior of the theca, appear to be a continuation of the lining; whereas, in all the *Weissia*, the teeth either spring from the surface of the stoma, or immediately from within; and are formed at the same time with the theca itself; but the supposed teeth being thus only formed by the splitting of the horizontal membrane which connects the lining of the theca with the summit of the columella (and which we have already remarked to be peculiarly strong in *Gymnostomum*), the plant should perhaps be retained among those destitute of a true peristome †.

Dr HOOKER has published a new and singular species of *Gymnostomum* in his exquisite *Musci Exotici* ‡, under the name of *Capense*, which Mr BROWN conceives to form of itself a distinct genus, named by him *Glyphocarpa* ||. Unfortunately the latter has published no character; but, whatever it be, it assuredly ought not to rest on the form or striæ of the theca, as, by the same principle, *G. Lapponicum* might also be removed; and *Bartramia arcuata*, on

* By the plate in English Botany, the peristome is decidedly that of an *Orthotrichum*; and indeed were the *Muscologia Britannica* and English Botany description of *actual teeth* to be correct, we would feel rather inclined to constitute of this a new genus, and arrange it close to *Calymperis*, in the *Orthotrichoideæ*.

† Since the plates for this paper have been engraved, we have observed, in *Gym. microstomum*, a similar structure, the horizontal membrane, which is usually striated, being, by age, turned upwards into sixteen very obtuse teeth. May not, in a similar way, *Weissia affinis* of HOOKER and TAYLOR'S *Muscologia*, be merely *Gymnostomum conicum*, from which it does not otherwise differ?

‡ *Musc. Exot.*, vol. ii. t. 165.

|| *Linn. Trans.* vol. xii. p. 575.

account of its smooth theca, be separated from all the remaining *Bartramiaë*. As long, therefore, as generic distinction is rigorously taken from the fructification, it will, if Dr HOOKER's character be correct, remain in that group among which he has placed it.

Depranophyllum of RICHARD, first published by Dr HOOKER as a *Dicranum*? is another very extraordinary plant, which we have hitherto alluded to in the light of a doubtful *Gymnostomum*; the fact is, no character has yet been formed which excludes it from that genus. From its most peculiar habit alone, we have no hesitation in believing it to be totally distinct; at the same time, the little that is known about it, renders it impossible for us to notice it, except in this place*. SCHWÆGRICHEN also describes and figures it in his second Supplement, and makes the sole character depend on the naked male flowers. Were we to hazard an opinion, we should be inclined to consider it an *Anictangium*, and not far from *An. torquatum*, with which it has a considerable affinity; and if its calyptra be ultimately proved to be mitriform, we would feel inclined in that case to destroy the next genus we are to describe, *Schistostega*, and form the whole into a distichous-leaved section of *Anictangium*.

Species referable to other genera, are, *G. pennatum* (vid. *Schistostega*), *G. aquaticum* (vid. *Hedwigia*). *G. pulvinatum* and *subsessile* belong to *Anictangium*. *G. prorepens*, retained as such by all authors, we have ascertained to possess sixteen geminate teeth, without a capitate columella, so that it belongs to the *Orthotrichoideæ*. From an

* We wrote, some time ago, to our friend M. ACHILLE RICHARD, requesting him, if possible, to examine his father's specimens, and endeavour to discover something additional respecting the fructification. We have not yet been favoured with an answer to our queries.

examination of many specimens we have also ascertained that the calyptra is actually mitriform; though, from its irregular splitting at the base, it sometimes appears with one predominant fissure, or dimidiate, as in HEDWIG'S figure: this plant is therefore a true *Orthotrichum* *.

PLATE II.

- Fig. 1. Theca of *Gymnostomum Donianum*, shewing the elongated columella.
2. A young plant of the same species.
 3. A mature calyptra of the same.
 4. Theca of *Gym. microstomum*, with the membrane within the orifice.
 5. Theca of *Gym. Griffithianum* exhibiting the same structure.
 6. Theca of *Gym. viridissimum*.
 7. Theca of *Gym. involutum* divided, to shew the columella.
 8. Calyptra of the same.
 9. Theca of *Gym. pyriforme*, with the expanded membrane within the mouth.
 10. The mouth of the theca of the same dissected, and more highly magnified; it exhibits the summit of the columella expanding into a membrane which is attached to the top of the lining of the theca; the sporules are seen within.
 11. Calyptra of the same species when full grown. In a young state it is almost mitriform.

* We find that BRIDEL once formed a genus of this plant, called *Anodontium*, which Mr Brown seems rather inclined to favour, by mentioning, in Linn. Trans., vol. x. p. 315., that he had ascertained two new species. BRIDEL, however, in his *Methodus nova Muscorum*, reduces the genus again to *Gymnostomum*.

GYMNOST^m SCHISTOSTEGA ANICTANG^m HEDWIGIA.





12. Operculum of *Gym. fasciculare*.
 13. Do. of *Gym. conicum*.
 14. Do. of *Gym. involutum*.
 15. Cellules of the leaves of *Gym. Griffithianum*.
 16. Do. of *Gym. pyriforme*. Similar to which are those of *Gym. fasciculare* and *Gym. (Pyramidula) tetragonum*.
 17. Do. of *Gym. minutulum*; which may also serve to represent those of *Gym. truncatum* and *ovatum*.
 18. Do. of *Gym. Donianum*; resembling also those of *Gym. conicum*.
 19. Do. of *Gym. Xanthocarpum*.
 20. Do. of *Gym. tortile*.
 21. Do. of *Gym. microstomum*. (The smallest reticulation of any of the *Gymnostoma*.)
- All the figures more or less magnified.

GEN. VI. SCHISTOSTEGA, *Mohr*.

FRUCT. *Calyptra* mitræformis*, basi integra, fugax, theca paulo brevior, tenera, pallido-fuscescens, laxè reticulata. *Seta* terminalis, cauli subæqualis, lutescens demum rufescens, erecta, capillaris, nunquam tortilis, apice paululum incrassata. *Apophysis* nulla. *Theca* integra, lævis, subglobosa, minutissima, maturitate luteo-fusca, ore contracto, incrassato, thecæ concolore † absque annulo. *Operculum* tenerrimum, convexiusculum, striato-reticulatum,

* —“ integra secedit.” HEDW. Stirp. Cr.

† —“ luteo.” HEDW, Stirp. Cr.

“ non integrum, sed de summitate in lacinias irregulares illico sese revolventes decedens dilutissime rutilans*.” *Peristomium* nullum. *Columella* maturitate nulla. *Sporulæ* exiguæ, globosæ, pallido-virides, hyalinæ.

CHAR. DIFF. *Seta terminalis*. *Theca ore nudo*. *Operculum laciniatum, laciniis deciduis*. *Calyptra campanulata, basi integra*,

FRUCT. *Calyptra* mitriform, entire at the base, fugacious, somewhat shorter than the theca, tender, of a pale brownish colour, and loosely reticulated. *Seta* terminal, equal in length to the stem, yellowish, at length reddish, erect, capillary, never twisted, somewhat incrassated at the apex. *Apophysis* none. *Theca* entire, smooth, subglobose, excessively minute, yellowish-brown when mature; orifice contracted, with an incrassated margin, without an annulus, and of the same colour as the theca. *Operculum* delicate, slightly convex, reticulated in a striated manner; “ not entire, but splitting from the centre into irregular laciniaë, which are revolute and deciduous, and of a very pale red colour.” *Peristomium* none. *Columella* in the mature theca none. *Sporulæ* exceedingly minute, globose, pale green, pellucid.

DIFF. CHAR. *Seta terminal*. *Theca with a naked mouth*. *Operculum laciniated, the laciniaë deciduous*. *Calyptra campanulate, entire at the base*.

VEG. The roots of *Schistostega* are simple or branched, of a brownish colour, and pellucid. The stems are simple,

* HEDW. Stirp. vol. i. p. 78.

or most rarely branched, one to three-fourths of an inch in length, filiform, erect, and flexuose; naked from the base to about two-thirds of the whole length, when it becomes clothed with distichous leaves of a lanceolate form, plane, bright green, nerveless, entire, and loosely reticulated;—“they are decurrent at the base, but by no means confluent; those in the centre are the longest, and they gradually diminish in size above and below*.” The perichæatial leaves are much narrower than those of the stem.

OBS. The calyptra of this moss we have found, by careful examination, to be campanulate, or entire, as HEDWIG describes it. Few authors seem to have noticed it since his time from their own observation. As to the operculum, we have borrowed part of our character from HEDWIG, having never been able to satisfy ourselves completely respecting the laciniaë, but this we shall mention more particularly when we come to the history. If we consider the excessive minuteness of the theca, its form, and naked stoma, no other known moss can be confounded with it; the foliage, however, much resembles that of *Dicranum bryoides*, for which, as Dr HOOKER remarks, it has probably been frequently passed over. Among the *Gymnostomoideæ* it approaches to *Drepanophyllum* alone.

HAB. This singular moss seems to be confined to Europe, and hitherto has chiefly been observed in the northern division. In Britain, the only known stations are in Devonshire, where it was originally discovered by the Reverend Mr NEWBERRY, on the road from Zele to South Tawton Church, four miles from Okehampton. This habitat, about

* HOOK. and TAYL. Musc. Brit:

three years ago, we spent some days in examining without success. Since that time, however, this plant has been rediscovered by our friend the Reverend J. S. TOZER, who finds it on hedge-banks by the side of the Kings-bridge Road, a few yards after leaving the old road from Totness to Plymouth; also near the village of Harberton, about two miles and a half from Totness; and near Chelwill, in the same parish. He has likewise a fourth station, at Meavy Parsonage, near Horrabridge. Mr TOZER also writes, "I have invariably found it in the hollow mouldering part of our high hedges, the earth of which as the summer advances scales off, and renders it difficult to detect at that season of the year." SMITH's account agrees well with this: "In cavitatibus aggerum, sub sepibus vetustioribus, solo pingui*."

HIST. This moss was first described by DICKSON †, under the name of *Mnium osmundaceum*. HEDWIG very soon afterwards published it in his "Stirpes" as a *Gymnostomum* ‡; and EHRHART, about the same time, as *Dicksonia pusilla*, in his "Plantæ Cryptogamæ." It was still continued, however, as a *Gymnostomum* (*G. pennatum*) by HEDWIG in the Species Muscorum, and by SCHWÆGRICHEN in the Supplement. MOHR, in 1803 and in 1807, conjointly with WEBER, made a distinct genus of it, on account of the remarkable operculum, and named it *Schistostega*, a genus which is retained by the authors of the British Muscologia. HEDWIG, in his Stirpes already quoted, thus describes the *operculum*: "Non integrum, sed de summitate in lacinias irregulares illico sese revol-

* Fl. Brit. p. 1161.

† Crypt. Fasc. i. p. 3. t. 1. f. 4.

‡ Vol. i. p. 77. t. 29.

ventes decedit." WEBER and MOHR say, "Operculum ab apice fissum in lacinias revolvendo-aufuges." SCHKUHR positively denies this structure; and BRIDEL, in his last work, "Methodus nova Muscorum," fully agreeing with that author, observes at some length,—“SCHKUHRIUS acerrimus muscorum investigator e soli veritati studens, HEDWIGIUM graviter erravisse in observatione, descriptione et adumbratione hujusce musci operculis, nos edocuit. HEDWIGIUS nempe illiis striis tenerrimis a centro ad perisphæriam radiantibus ornatum esse, nec integrum sed de summitate in lacinias irregulares illico sese revolventes ac delabentes (quod casu semel fieri potuit) discedere affirmat. Tanta auctoritate moti WEBERUS MOHRUSQUE, imo idem se observasse dictitantes novum genus *Schistostega* a fissio operculo dictum effinxerunt. SCHKUHRIUS autem diu et pertinaciter hujusce musci capsulam percontatus operculum nec aliter reticulatum nec alio pacto quam in cæteris muscis abscedens invenit, quamvis valde tenerum fugaxque esse fateatur. Genus igitur *Schistostega* natura repudiat ipsa, et nomen illud in Muscologia non aliter quam *Trentepohlia* remanebit, nempe, argumenti instar optimos observatores facile in errorem delabi, si naturam paulo segnius aut mente jam præoccupata scrutantur.”

Notwithstanding the high authority of SCHKUHR, and BRIDEL's opinion of him, and we are led to believe that SCHWÆGRICHEN now agrees with them on that point, we certainly cannot suppose that HEDWIG's description of the lacinated operculum originated wholly in imagination. Mr TOZER, who has examined this part very attentively, informs us, that one, which he placed under the microscope, split, on being touched, into many segments radiating from the *circumference to the centre*; which, though it contradicts HEDWIG's character, "de *summitate* in lacinias," &c.,

yet contributes to establish the existence of a peculiar structure*. We ourselves, after repeated scrutiny, and lately, even in company with the learned authors of the *Muscologia Britannica*, have not been so fortunate. We could, however, perceive a series of striæ filled up by a reticulated vasculose structure, which, under favourable circumstances, might split in the manner described. Upon the whole, therefore, (not forgetting the uncommon habit of the plant, so unlike any *Gymnostomum*), we feel inclined, with MOHR, to consider it as a distinct genus. Besides, the calyptra is distinctly entire, which is sufficient of itself to remove it from *Gymnostomum*.

PLATE II.

- Fig. 22. & 23. Thecæ of *Schistostega pennata*, the first without the operculum.
24. Operculum of the same, shewing the striated and vasculose structure, as it appeared to us.
25. Calyptra of the same.
26. Sporules.
27. An entire frond.
28. Cellular structure of the leaf.
- All the figures are more or less magnified.

* This structure, as far as we may judge by HOOKER'S Plate, appears also to exist in *Drepanophyllum*; unless this be owing to the remains of some teeth lurking in the interior, as we have perceived in *Hedwigia Schmidtii* (HOOK.); in that case, *Drepanophyllum* must be again removed to the *Dieranoideæ*.

GEN. VII. ANICTANGIUM, *Hedw.*

FRUCT. *Calyptra* mitræformis plus minusve ad basin in lacinias irregulares fissa, quandoque pseudo-dimidiata, pallida, lævis, glabra. *Seta* terminalis, perbrevis, sæpius vix ulla, recta, rigida, thecæ concolor. *Apophysis* nulla. *Theca* quandoque subcylindracea, plerumque tamen turbinata, integra, nec sulcata nec striata, lævissima, rutilans seu fusca, ore nudo, subamplo crassiusculo colore saturatiore. *Operculum* deciduum, integrum, umbonatum seu convexo-rostratum, thecæ concolor, irregulariter celluloso-reticulatum. *Peristomium* nullum. *Columella* valde collapsa, et in fundo thecæ retracta*. *Sporulæ* magiusculæ subsphæricæ, reticulatæ; in una specie tripartitæ, punctatæ.

CHAR. DIFF. *Seta* terminalis. *Theca* ore nudo. *Operculum* deciduum, integrum. *Calyptra* mitræformis, basi irregulariter fissa.

FRUCT. *Calyptra* mitriform, cleft more or less into irregular segments at the base, sometimes even pseudo-dimidiate, pale, without striæ, glabrous. *Seta* terminal, extremely short, sometimes almost none, straight, rigid, of the same colour as the theca. *Apophysis* none. *Theca* sometimes almost cylindrical, but generally turbinate, entire, smooth, neither sulcated nor striated, reddish, or brown; the mouth naked, usually large, somewhat thickened, and of a deeper colour. *Operculum* deciduous, entire, umbonate or convexo-rostrate, of the same colour as

* Una in specie solummodo bene observavimus.

the theca, irregularly reticulated. *Peristome* none. *Columella* collapsed into a minute globular mass at the bottom of the theca. *Sporules* rather large, subspherical, reticulated; in one species tripartite, and punctated.

DIFF. CHAR. *Seta* terminal. *Mouth of the theca* naked. *Operculum* deciduous, entire. *Calyptra* mitriform, cleft irregularly at the base.

VEG. The stems of the species in this genus grow in a tufted manner, and are in all the species but one considerably branched. In *A. ciliatum*, *filiforme* (MICH.), *imberbe** (HOOK. & TAYL.), *repens* (HOOK.), and *torquatum* (HOOK.), they are either decumbent or creeping; in all the others, erect. Those of *A. torquatum* are tomentose beneath; “caulibus ramisque inferne ubique tomento ferrugineo obsitis, stipulisque admixtis †.” It is remarkable, that, in this genus, the leaves of most of the species are entirely destitute of a nerve,—a circumstance which assuredly contributes to mark a natural limit between it and *Gymnostomum*. A nerve, however, terminating in a piliferous point, is present in *A. pulvinatum* and *sessile*; and there is a percurrent one, of a brown colour, and remarkable strength, in *A. torquatum*. In regard to form, the leaves are usually ovate, obtuse, acuminate, and sometimes serrated at the apex; but in *A. torquatum*, they are ligulate, somewhat undulate, and “when dry, are so much curled as to cover the whole upper surface of the stem; and if macerated for ever so great a length of time, continue involuted in a most remarkable manner ‡.” It is also

* *A. filiforme* and *imberbe*, certainly do not differ from each other; and we are even inclined, along with WEBER and MOHR, and BRIDEL, to add them both to *A. ciliatum*.

† HOOK. Musc. Exot. t. 41.

‡ HOOK. loc. cit.

worthy of notice, that, in *A. torquatum*, they are distichous, while in all the other species they are “spissa imbricata.” The perichæatial leaves also vary, though not much, from each other. In *A. ciliatum* they are lacinated towards the apex, while the cauline ones are only denticulated. In *A. torquatum* they are erect, lanceolate, and imbricated, differing very widely from those of the stem.

Obs. The *Anictangia* bear considerable affinity to a few *Gymnostoma*, and in some instances come near to several *Grimmia*; from all of which, however, a slight examination shews them to be sufficiently distinct*. The genus, if the species be compared with each other, seems to divide naturally into two sections; of which *A. ciliatum*, *imberbe*, *filiforme*, *repens*, and perhaps *sessile*, would form the first.

The calyptras seem to vary exceedingly. In *A. pulvinatum*, HEDWIG represents it almost dimidiate; but SCHKURH, with more accuracy, makes it mitriform, with a few fissures at the base. SCHWÆGRICHEN figures and describes that of *A. sessile*, “subcampanulata lateraliter secedens;” and WEBER and MOHR agree by saying, “mitriformis in plures lacinias fissa, fissura una prævalente.” Again, in *A. cæspitium*, SCHWÆGRICHEN delineates it completely dimidiate, but describes it “conica, basi bis aut pluries fissa;” and WEBER and MOHR, to reconcile all parties, say, “dimidiato-mitriformis.” BRIDEL notices the contradiction between SCHWÆGRICHEN’s figure and description; “Calyptram SCHWÆGRICHENII icon valde diversam ab ejus

* With *Grimmia*, *Anictangium* has nevertheless been confounded; for, by an examination of PALISSOT DE BEAUVOIS’ own specimens, we found his *Hedwigia (Anictangium) nervosa* to be nothing more than *Grimmia apocarpa*, var. β , or *Grimmia stricta* of TURNER, Musc. Hib.

descriptione sistit.” Notwithstanding all these discrepancies, as far as our own observations extend, the calyptra may be pronounced truly mitriform; and in most, nay, in all, the species hitherto known to us, more or less cleft into several basilar fissures. This circumstance shews how closely this genus is allied to *Gymnostomum*, for in *G. pyriforme*, and some others, the calyptra is almost mitriform.

All the calyptras we have observed are glabrous; but RICHARD*, in MICHAUX’S Fl. Bot. Am., describes that of *A. filiforme* as subvillose; a fact doubted by WEBER and MOHR, who suggest, “an lusus naturæ?” and also by BRIDEL, “quod accuratius inquirendum.” Unfortunately in those specimens received from M. ACHILLE RICHARD, we have not been able to discover a single calyptra; but in others, from Boston, sent us lately by Mr GREENE, we have at length detected it, and found it apparently furnished with a few hairs. It ought, however, to be remarked, that, in this American variety, the ciliæ, towards the extremity of the perichæatial leaf, are so extremely brittle, as soon to render the leaf only serrated, and, from the structure of the hairs on the calyptra, we have little doubt that they are simply the broken and detached ciliæ of the leaf: we therefore still consider the calyptra to be, strictly speaking, glabrous.

HAB. The *Anictangia* appear to be as widely distributed as their neighbours the *Gymnostoma*. Europe,

* On examining the Herbarium of RICHARD, we found the following excellent description of this variety, which we take the liberty to publish:—
 “Folia arcte quasi squamatim imbricata, ovalia acuminata; involucri folia superne ciliata; operculum conoideum, muticum; calyptra caduca, oblonga, conoidea *subvillosa*; peristomium nudum.”

North and South America, and New Holland, possess a greater or less number. The species so abundant in this country was found by Mr BROWN in Australia, and has recently been sent to our friend Dr HOOKER, from Nepal. *A. imberbe*, found in Ireland, does not appear to differ from that in North America. All, we believe, grow either on the ground or on rocks.

HIST. We have adopted the genus nearly according to the definition given by Mr TURNER in his *Muscologia Hibernica*, and by Drs HOOKER and TAYLOR in the *Muscologia Britannica*, which differs considerably from that given by HEDWIG. It is the same as *Hedwigia* of PALISOT DE BEAUVOIS, but more precisely the *Schistidium* of BRIDEL, whose *Anictangium*, by the definition, is the *Hedwigia* of HOOKER. One species, *A. ciliatum*, was indeed described by EHRHART, and by HEDWIG in his *Stirpes*, under the name of *Hedwigia*; but that name was afterwards changed in the *Species Muscorum* to *Anictangium*; which species, it may be observed, was called a *Sphagnum* by DILLENIUS, and made by LINNÆUS (under the generic name of *Bryum*) a variety of *Grimmia apocarpa*.

In the *Species Muscorum* seven species are enumerated, of which one only ought to be retained. SCHWÆGRICHEN, in the *Supplement*, describes ten, from which eight may be rejected; but, at the same time, two of his *Gymnostoma* should be added. BRIDEL'S *Anictangium*, on which we shall enlarge in the next genus, contains two plants, neither *Anictangia* nor *Hedwigia*. In this country, Mr TURNER was the first to adopt the genus, and describe one species; another was added in the *Muscologia Britannica*; two more in the *Musci Exotici*; and one,

which we have however not seen, has been described by SPRENGEL in his "Neue Entdeckungen."

The principal alterations made in this genus, since SCHWÆGRICHEN published the Supplement, consist in the rejection of *A. setosum*, *bulbosum*, *planifolium*, and *cirrhosum*. The first, as a *Neckera*, and the second as a *Hookeria*, have been beautifully delineated by Dr HOOKER in his *Musci Exotici*, which may be consulted for further information. *A. planifolium* is still undecided, and from not having been seen by SCHWÆGRICHEN, is probably not in HEDWIG'S Herbarium. It appears not to differ materially from *Hypnum aciculare*, as SCHWÆGRICHEN himself conjectures; and there is little doubt of its having a double peristome. As to *A. cirrhosum*, it is most wretchedly figured in the *Species Muscorum*; but has, in the second part of the first Supplement, been called a *Schlotheimia*. BRIDEL also coincides in this. WEBER and MOHR in their *Synopsis Muscorum* make it a *Ulota*. We regard it as an *Orthotrichum**, thinking that *Schlotheimia*, *Ulota*, and *Macromitrium*, do not essentially differ from that genus.

PLATE II.

- Fig. 29. Theca of *Anictangium ciliatum*.
 30. Calyptra of the same.
 31. Operculum do.

* We allude here to a plant which is not uncommon in herbaria in this country, under HEDWIG'S name. This has very long leaves, *serrated* towards their extremity. But is this really HEDWIG'S plant? We must trust to SCHWÆGRICHEN, and the German muscologists, for information. We also possess another, perhaps more likely to be the true *A. cirrhosum*, as it has entire leaves; this, again, we consider only a variety of *Orth. pallidum*, (P. B.)

32. Structure of the operculum of the same:
 33. Theca of the same divided, to shew the retracted
 and small columella at the bottom.
 34. A perichæatial leaf, and,
 35. A cauline leaf of the same species.
 36. Sporules do.
 37. Theca and perichæatial leaf of *Anict. repens*;
 copied from HOOKER.
 38. Cauline leaves of *Anict. torquatum*.
 46. Structure of the leaf in *Anict. ciliatum*.
 All the figures more or less magnified.

GEN. VIII. HEDWIGIA.

FRUCT. *Calyptra* dimidiata, thecæ subæqualis, scariosa (ut in ferè omnibus muscis), straminea. *Seta* lateralis, tres ad octodecim lineas longa, plerumque caules longe superantes, rigida, stricta vel rarius tortilis, fusca, ad summitatem sæpius incrassata. *Apophysis* nulla. *Theca* integra, lævissima (in una tantum specie siccatione sulcata) vel globosa, vel subcylindræa, fuscescens, ore nudo, in quibusdam amplo, in aliis contracto, in omnibus? crassiusculo, rubescenti. *Operculum* deciduum, integrum, subulatum vel rostratum, thecæ concolor. *Peristomium* nullum. *Columella* filiformis*. *Sporulæ* (in *H. aquatica*) sphæricæ, tripartito-reticulatæ, pellucidæ.

* In una specie subulata, stricta, ad operculi apicem porrectens, siccitate sulcata; in cæteris plane nobis ignota.

CHAR. DIFF. *Seta lateralis*. *Theca* ore nudo. *Operculum* deciduum, integrum.

FRUCT. *Calyptra* dimidiate, nearly as long as the theca, scariose (as in most mosses), yellowish. *Seta* lateral, three to eighteen lines in length, mostly rising considerably above the stem, rigid, straight, brown, often somewhat incrassated at the apex. *Apophysis* none. *Theca* entire, very smooth (in one species sulcated when dry), globose or subcylindrical, brown; the mouth naked, large in some, and contracted in others, always? somewhat thickened and reddish. *Operculum* deciduous, entire, subulate or rostrate, of the same colour as the theca. *Peristomium* none. *Columnella* filiform. *Sporulae* (only observed in *H. aquatica*) spherical, tripartite, and pellucid.

DIFF. CHAR. *Seta* lateral. *Theca* with a naked stoma. *Operculum* deciduous, entire.

VEG. The stems of the *Hedwigia* are much branched, as might be generally inferred from the fructification being lateral. In one species they are floating, in another procumbent, in the others erect; in *H. Hornschuchiana* they are also densely matted. *H. Humboldtii* and *secunda* are branched in a subpinnated manner. The leaves differ much in shape, passing from obovate to subulate, and are in some species destitute of a nerve; but there is one in *H. aquatica*, and one also remarkably broad in *H. Hornschuchiana*. The leaves are rarely piliferous, and as rarely serrated; they are smooth or striated, inserted on all sides of the stem, erect, and sometimes flexuose or secund.

OBS. Several species of this genus bear a strong resemblance by their leaves to *Anictangium*. *H. Hornschuchi-*

*ana** in habit comes near to *Gymnostomum rupestre*. Some are also in habit nearly allied to several *Leucodontes*, to *Hypnum*, *Fontinalis*, and to some *Neckera*. Indeed, were it not from a wish to bring all the Gymnostomoid plants together (on account of their characteristic fructification), we would have confined that tribe to those genera furnished with *terminal* setæ alone, and have removed *Hedwigia* to the Hypnoid division.

The calyptra seems in all to be strictly dimidiate. JACQUIN, in his *Flora Austriaca*, made it mitriform, but he had only seen it in a young state. "Calyptra mihi pluries omnino dimidiata subulata, cuculliformis," says BRIDEL, and we entirely accord with him.

HAB. These plants are natives of Europe, South America, Guadeloupe, and some of the South Sea Islands. None are found in Britain, though *H. aquatica* is by no means very rare on the Continent. Their situation is various, some growing in water, others on rocks and trees. They seem also to be exposed to a considerable range of temperature; from the mild rivulets in the south of France to the "loca frigida" of the Andes.

HIST. The only species known to DILLENIIUS and LINNÆUS was described by them as *Hypnum aquaticum*. HEDWIG, in his *Stirpes*, changed the generic name to *Hedwigia*; but afterwards, in his *Species Muscorum*, removed it to *Anictangium*, in which he was followed by SCHWÆGRICHEN in the Supplement to that work. The

* May not SCHWÆGRICHEN's conjecture be correct? "H. Hornschiana ambigua videatur, nisi forte flos femineus initio, etiam terminalis sit, et tantum per caulis innovationem lateralis reddatur." We ourselves have little doubt on the subject, and only hesitate to remove this plant to *Gymnostomum*, until we shall have an opportunity of examining more specimens.

analysing authors of the *Muscologia Britannica* first clearly explained, in the preface to their admirable work, the proper method of separating this genus from its allies; and Dr HOOKER, in *Musci Exotici*, has added several species. BRIDEL's definition of *Anictangium*, "PLEURO-CARPI; *stoma nudum*; *calyptra dimidiata subulata*," does not separate it from *Hedwigia*; and it is curious that the two "undoubted" species which he describes, are plants of two other genera, the one being a *Neckera*, and the other a *Gymnostomum*; and *Hedwigia aquatica*, which has truly lateral setæ, he places under *Gymnostomum*, characterised by its terminal setæ!

In regard to the new species published by Dr HOOKER, one was called an *Anictangium* by HORNSCHUCH; and another is the *Leucodon Canariense** of SCHWÆGRICHEN and other authors. Of this, Drs HOOKER and TAYLOR, in the Adenda to the *Muscologia Britannica*, remark, "We have received plants of *Leucodon Canariense* (Schwægrichen) from our late lamented friend Professor SCHMIDT of Norway, which he gathered in the Canary Islands; and we can safely assert that it does not belong to this genus." In *Musci Exotici*, we accordingly find this plant figured and described as *Hedwigia Schmidtii*, but, probably by an oversight, there is no mention made of its being identical with *Leucodon Canariense*, which we find to be the case, from the examination of specimens of the *Hedwigia* re-

* We might perhaps add to these *H. Humboldtii*, of which we have seen specimens received by Dr HOOKER from Guadaloupe, under the name of *Hypnum taxiforme* (BRID.), and said to have been named by SPRENGEL. We are afraid yet to assert them to be identical, until we have seen SCHWÆGRICHEN or BRIDEL's plant, especially as that from Guadaloupe does not well agree with their descriptions. May not, however, *Hyp. nigrocaule* be the same with *Hed. Humboldtii*?

ceived from Dr HOOKER himself, and compared with the *Leucodon*, which was presented to us by botanical friends abroad. In this moss, the same learned bryologist remarks, “Capsula ore contracto, intus membrana annulari alba;” and afterwards, “The annular membrane within the mouth of the capsule of this moss was noticed by its lamented discoverer Dr CHRISTIAN SCHMIDT, and it is very evident in all the specimens I possess.”

Notwithstanding, this plant is really a *Leucodon*: we observed the above mentioned membrane exhibiting, as it were, traces of sixteen separate teeth, each furnished with a dark longitudinal line; and it gave us therefore no small pleasure to find the sixteen broken-off parts of the teeth adhering closely to the interior of the operculum. Thus, DILLENIUS’s figure, tab. 39. f. 41. is more accurate than has been supposed.

PLATE II.

Fig. 39. Theca of *Hedwigia aquatica*, with the operculum on.

40. Sporules of the same.

41. Theca of the same divided, to shew the columella, which is elongated to the summit of the operculum.

42. Theca of *Hedw. Hornschuchiana*.

43. Theca of *H. Humboldtii*, copied from HOOKER.

44. Calyptra of the same.

45. Structure of the leaf in *Hedw. aquatica*.

All the figures more or less magnified.

BUXBAUMOIDEÆ, Gen. (9—10.)

CHAR. *Calyptra mitriformis, fugax. Seta terminalis. Theca gibba, obliqua, margine oris plus minusve crenulato. Operculum conicum. Peristomium, membranum conicum longitudinaliter plicatum ex interiore ortum, sine vel cum peristomio exteriori e processibus filiformibus constante. Columella perlonga ad operculi summitatem porrectens.*

CHAR. *Calyptra mitriform, fugacious. Seta terminal. Theca gibbous, oblique, the mouth being more or less crenulate. Operculum conical. Peristomium furnished with a conical membrane, longitudinally plicate, arising from within the stoma, either without, or accompanied with, an external peristome of numerous filiform processes. Columella very long, reaching to the summit of the operculum.*

Obs. The two genera we have here associated together are most nearly connected, as well by the peculiar form of the theca, as by the similar, conical, plicate, white membrane, with which the stoma is furnished.—“Of the propriety,” says Dr HOOKER, “of their being placed next each other there can be no question, notwithstanding that one has a single peristomium, and the other a double one; their habit requires it; and if we were to consider alone the number of these parts, there would be no difficulty in assigning them a situation; the one to be last in the division of mosses with the single peristomium, the other the first in those with double ones. Yet this would, in other points of view, be unnatural, *Diphyscium* having more affinity with the genus *Leptostomum*, and some of the *Gymnostoma*

with membranous borders to the mouth, than with *Weisia*, *Dicranum*, and *Trichostomum*." Dr HOOKER proceeds, however, to state, "I therefore think that our two genera might be brought near to *Leptostomum* of BROWN, in consequence of their being furnished with a membranous peristome: and *Buxbaumia* may claim to be separated not only from the double-fringed mosses, but from the generality of the single-fringed ones, from the circumstance of the teeth, or cilia, not exhibiting any appearance of articulation, along with *Dawsonia* and *Polytrichum**."

In much of these observations we readily concur, and have consequently assigned this place to the *Buxbaumioideæ*; in respect, however, to their affinity with *Leptostomum*, we cannot but dissent from Dr HOOKER, and consider that genus (as, indeed, has been already remarked by Mr BROWN) far more nearly allied to *Bryum*.

GEN. IX. DIPHYSCIUM.

FRUCT. *Calyptra* conico-acuminata, mitræformis, fugax, theca multo brevior, operculo subæqualis, membranacea, fuscescens. *Seta* terminalis, perbrevis, lævis, thecæ concolor. *Theca* dubie apophysata (interne columna cylindracea saccum sporuliferum sustinenti inferne insigniter dilatata), integra, lævis, "ovata obliqua supra parum depressa, sed basin versus gibbosa, subtus ventricosa," vicinæ

* The two plants forming this group have been so ably and so fully described by Dr HOOKER in the New Series of the "Flora Londinensis," that our readers will find almost nothing additional in this portion of our paper; his descriptions are so accurate that we have frequently borrowed whole passages from that work, which we have marked by inverted commas.

sativæ seminis magnitudine, viridis, demum fusco-flavescens, foliis perichætialibus immersa; ore contracto, ad marginem sedecies? subcrenulato. *Operculum* elongato-conicum, rectum, deciduum, thecæ concolor. *Peristomium* simplex ex interiore ortum, "tenerum, membranaceum, albidum, conum efformans," erectum sedecies? "plicatum, striatum; siccitate subtortuosum." *Columella* permagna lævis, membranacea, ventricosa, elongata, ad operculi summitatem anteriorem affixa; inferne fusca, superne alba. *Sporula* exigua, fusca, globosa, pellucida.

CHAR. DIFF. *Theca peristomium simplex, membrana conoidea truncata plicata. Calyptra mitræformis.*

FRUCT. *Calyptra* conico-acuminate, mitriform, fugacious, much shorter than the theca, but nearly of the same length as the operculum, membranaceous, pale, brownish. *Seta* terminal, exceedingly short, smooth, of the same colour as the theca. *Theca* furnished with a dubious *apophysis* (having the small cylindrical pillar supporting the sporular sac dilated at the base), entire, smooth, "ovato-oblique, somewhat depressed above, but gibbous towards the base, ventricose below," greenish, at length brownish-yellow, immersed among the perichætial leaves; the mouth contracted, obscurely crenate at the margin into sixteen? segments. *Operculum* elongato-conical, straight, deciduous, similar in colour to the theca. *Peristomium* simple, arising from within the stoma, "delicate, membranaceous, white, forming a plicate cone," erect, "striated, when dry somewhat twisted." *Columella* very large, smooth, membranaceous, ventricose, elongated, fixed to the interior summit of the operculum, fuscous beneath, white above. *Sporula* very minute, fuscous, globose, pellucid.

DIFF. CHAR. *Peristome simple, formed of a conical, truncate plicate membrane. Calyptra mitriform.*

VEG. This plant grows in thick and often widely extended patches; including the leaves, it is not more than two or three lines in height. The stems are extremely short. The root is small, and, like a little mass of ferruginous down, similar to (what is usually called) *Conferva castanea**. The cauline leaves are few in number, and crowded, small in comparison with those of the perichæcium, and various in their direction: they are crisped when dry, of a thick opake substance, and of a lurid green colour; they are also undulate, and slightly carinate, with a very entire margin and strong nerve. The lower leaves are lingulate and obtuse, with the nerve for the most part reaching to the apex; while the upper ones, or those immediately beneath the perichæcium, are linear, subulate, "lanceolato-subulate" (WEB. and MOHR), "lanceolato-oblonga obtusa" (HOOK.), and the nerve somewhat excurrent; "folia infima nervo subexcurrente, folia media nervo subexcedente" (WEB. and MOHR); "folia utraque nervo sub apicem evanescente instructa" (HOOK.) The perichæcial leaves are remarkably large for the size of the plant, "numerous, erect, exceeding the length of the theca, and almost covering it, oblongo-lanceolate, acuminate, a little convex towards the apex, having the margin remarkably laciniate, or rather lacerate; it has a strong, rigid, brown nerve, much exceeding the length of the leaf, and is there serrulate. The substance of these leaves is rigid, yet membranaceous; the colour yellow-brown."

* This *Conferva* we suspect may be nothing else than radicular filaments. Some other *Confervæ*, such as *C. velutina* (as Mr DRUMMOND has ascertained), and *C. Pteridis* (according to the observations of Captain CAR-MICHAEL), are in the same predicament.

Obs. Few mosses are more curious in the internal structure of the theca than *Diphyscium*. When a mature theca (from which we can alone expect to draw conclusions in any moss) is divided, we find a considerable space between the outer wall and the sporular sac, the intermediate pulpy matter having early dried up, and left nothing but "numerous whitish, branched, jointed succulent fibres" connecting these two parts together. The pulpy substance above mentioned, seems, at an early stage, to have extended in this moss considerably below the sporular bag, where it contained in its centre a small cylindrical pillar, which is left entire on the shrinking of the above substance, and acts as a supporter to the sporular bag, but is evidently of a different nature. A support of this kind seems peculiarly necessary both in this and the following genus, on account of the distance between the sporular sac and the wall of the theca. But it must not be understood that we give this pillar or support to *Diphyscium* and *Buxbaumia* alone: on the contrary, we have now every reason to suspect that it is common to most mosses; we have during this spring seen it in the junior state of *Didymodon purpureum*, but in none is it so beautiful as in *Bryum ligulatum* and *Gymnostomum pyriforme*; of which last we regret that our plates were too much advanced in the engraver's hands to add dissections of this part.

Within the sporular sac we have always found a columella, formed as usual by the turning up of the sac, but fixed with it to the summit of the little pillar above mentioned. The best mode of observing it, is to puncture a ripe sac, and by repeatedly plunging it in water, wash out the spores; the sac may then easily be drawn down or away from the columella, which appears almost equal in size to the sac. The columella is furnished at its summit with an opercular membrane, of a whitish colour, reaching and

even adhering, to the summit of the operculum, well deserving the name, therefore, of elongated columella. Dr HOOKER says, "the extremity of the sac is lengthened out into a columella:" a minute dissection, however, very distinctly shews the columella to be continued from the base, and the sporular sac to be attached *to* it at the mouth of the theca. The columella, into which, according to Dr HOOKER, the sporular sac is lengthened out, is our opercular membrane; between which, and the summit of the columella *strictly* so called, the line of separation is very evident.

The peristome of this moss is worthy of much attention. It consists of a beautiful white, plicate, and slightly twisted cone. This HEDWIG considered to be formed entirely of ciliæ, connected together into a membrane furnished with sixteen sulcæ, or furrows. "I have myself seen," says Dr HOOKER, "what appeared to be distinct ciliæ, but whether they were really so, or only the plicæ of the membrane, I could not satisfy myself;" neither have we been able to trace any thing satisfactory beyond a mere ridge, formed by the duplication of the membrane.

Almost all authors describe the peristome of *Diphyscium* as double, mistaking the crenate margin of the theca for an outer one; but this appearance is, indeed, widely different from any thing like teeth. WEBER and MOHR observe, "Peristomium exterius vix ullum. Marginem oris crenulatum pro tali sumsit HEDW. EHRH. denegavit." Thus censuring HEDWIG, but adopting his opinion. BRIDEL and others represent the plicæ of the membrane as alternating with the crenulæ of the margin; in some cases we have clearly perceived this, but, as it depends upon the margin being cleft into a definite number of segments, it is rather uncertain whether it uniformly occurs.

HAB. Europe and North America, where it is chiefly found in subalpine countries, growing in woods, and dry, sandy, heathy places, on the ground.

HIST. This plant was described by HALLER and DILLENIIUS as a *Sphagnum*. By SCHMIDEL it was added to *Buxbaumia*, a genus to which it has been also referred by HEDWIG, SCHWÆGRICHEN, and a great many modern authors. JACQUIN and NECKER at different times made it a *Bryum*. HUDSON called it a *Phascum*, in which he was followed by LIGHTFOOT and others. EHRHART, finding the peristome to differ from *Buxbaumia*, threw it into a distinct genus, which he called *Webera*. MOHR, however, in his *Observ. Bot.* changed it to *Diphyscium*. *Hymenopogon*, the only other name it has since received, was bestowed by PALISOT DE BEAUVOIS, who was not aware at the time of that of *Diphyscium*. His name is justly remarked by Dr HOOKER, to be "so much more applicable, that we cannot but regret that it was published subsequently to MOHR's *Observationes*, which renders it impossible for it to be adopted."

PLATE III.

- Fig. 1. Plants of *Diphyscium foliosum*.
2. Theca of the same, with the operculum not removed.
 3. Calyptra.
 4. Operculum, with the upper part of the columella, which generally remains thus attached, if the operculum be forcibly removed.
 5. Peristome and mouth of the theca.
 6. Structure of the cauline leaf.
 7. Cauline leaves.
 8. Perichæatial leaf.

DIPHYSCIUM BUXBAUMIA

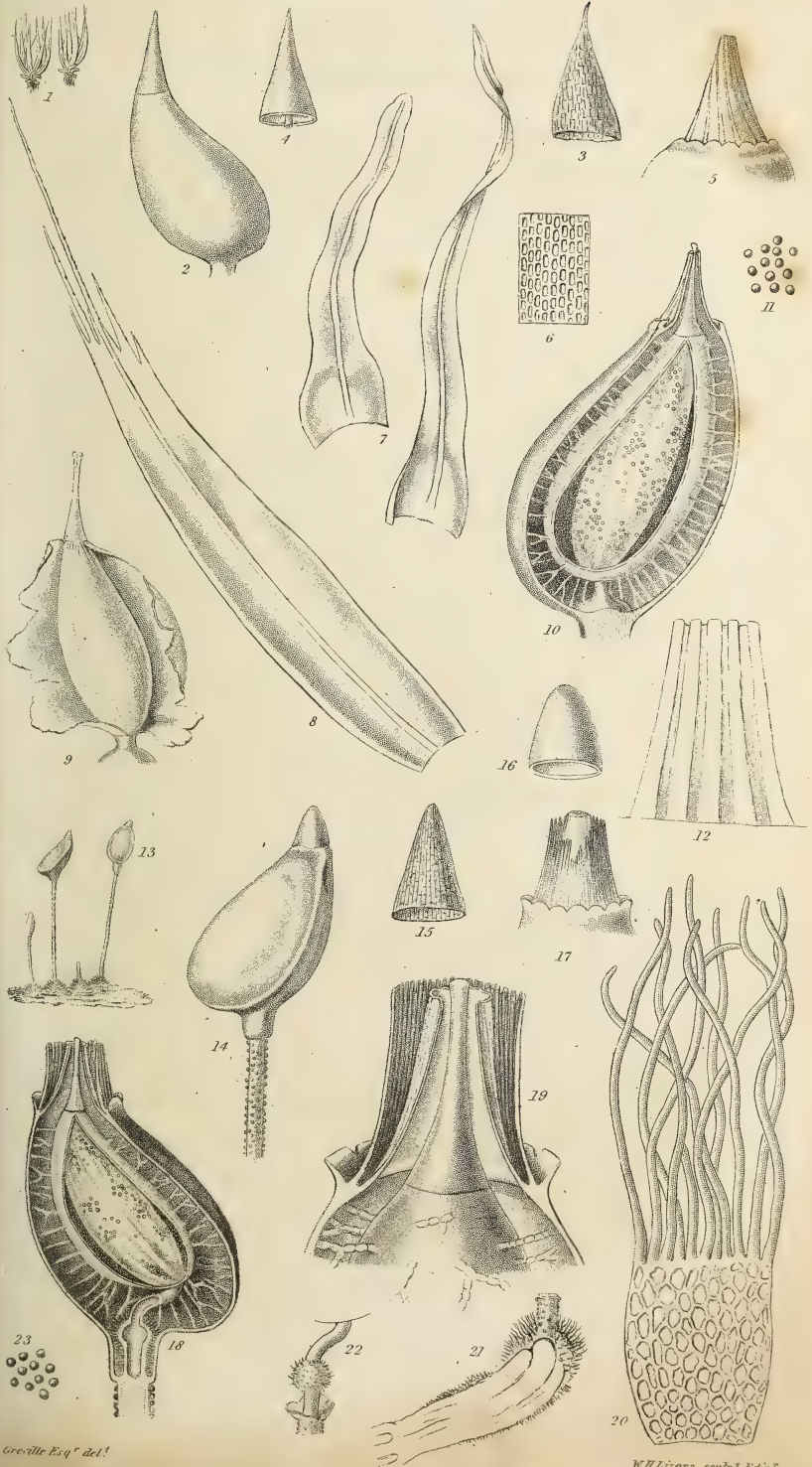



9. The columella and sporular sac removed from the theca; the columella with its elongation, is shewn by dividing and throwing back the sporular sac. Precisely the same appearance occurs in *Buxbaumia*.
10. A mature theca divided, and exhibiting the sporular sac connected with the sides of the theca by white-jointed filaments; the columella with its elongation passing through the conical peristome; and the whole supported by the small column, to the summit of which both the columella and sporular sac are most firmly attached.
11. Sporules.
12. A portion of the peristomium highly magnified. All the figures, except the first, more or less magnified.



GEN. X. BUXBAUMIA, *Haller*.

FRUCT. *Calyptra* conica vix acuminata, mitræformis, integerrima, fugacissima, brevis, membranacea, lævis, viridifuscescens. *Seta* terminalis, tres ad sex lineas longa, erecta, rigida, crassiuscula, cylindræa, tuberculata, nitidiuscula, ruberrima. *Apophysis* brevis, cylindræa, seta vix crassior, lævis, thecæ concolor, interne columna cylindrica saccum sporuliferum sustinenti medio in orbem inflata. *Theca* “ magna, ovata, obliqua, supra plana, submarginata, basi producta vel gibba, infra convexa,” “ parte superiore tenera, inferiore membranaceo-carnosa;” colore “ viridis, rubedine sæpe tincta, maturitate rufo-fusca,” oris margine elevato crenulato. *Operculum* obtuso-conicum, breve, rectum,

deciduum, læve, thecæ concolor. *Peristomium* duplex; *ext.* e “ciliis numerosis subæqualibus inarticulatis, subtorulosis, opacis, obscura rufescentibus; *int.* membranaceum, tenerum, albidum, conum efformans plicatum striatum,” rectum haud tortuosum. *Columella* permagna lævis, membranacea, ventricosa, elongata, inferne fusca, superne pallida. *Sporulæ* exiguæ, globosæ, ex viridi fuscæ.

CHAR. DIFF. *Theca peristomii duplex*; *ext.* e processibus filiformibus subconnexis; *int.* membrana conica plicata truncata. *Calyptra mitræformis*.

FRUCT. *Calyptra* conical, scarcely acuminate, mitri-form, very entire, fugacious, short, membranaceous, smooth, brownish-green. *Seta* terminal, three to six lines long, erect, rigid, thickish, cylindrical, rough with tubercles, somewhat shining, deep red. *Apophysis* short, cylindrical, somewhat thicker than the seta, smooth, of the same colour as the theca, within exhibiting the small pillar supporting the sporular sac, dilated in the middle into a little globe. *Theca* “large, ovate, oblique, above flattish, somewhat margined; at the base produced or gibbous, below convex; the substance in the upper part is thin and delicate, the rest between membranaceous and carnose; the colour greenish, often tinged with red, when ripe red-brown;” the margin of the mouth elevated and crenulate. *Operculum* obtusely conical, short, straight, deciduous, smooth, of the same colour as the theca. *Peristomium* double; *ext.* of “numerous, nearly equal, jointless, somewhat torulose, opaque, reddish cilia; *int.* membranaceous, delicate, whitish, forming a plicate and striated cone,” erect, scarcely at all twisted. *Columella* large, smooth, membranaceous, ventricose, elongated, brown beneath, pale above. *Sporulæ* minute, globose, green, at length brown.

DIFF. CHAR. *Peristome double; ext. of filiform sub-
 united processes; int. membranaceous, conical, plicate,
 truncate. Calyptra mitriform.*

VEG. The root of this most curious plant is rather more than a line in length, mostly tortuous, thick, fleshy, brittle, slightly hollow towards its extremity, which divides into two or three branches*. There is really no stem, but the leaves are situate on the summit of the root, and form to the naked eye a minute, brown, rough or bristly tufted mass, from the centre of which springs the seta. According to Mr BROWN, "the leaves of the barren plant are lanceolate, and but slightly divided. Those at the base of the female perichætium are even broader than the former, but more deeply cut, both laterally and at top, into several capillary segments; while the leaves which proceed from the surface of the perichætium are still more deeply divided, and their segments so much elongated, that the minute foliaceous base has been universally overlooked, and the perichætium consequently described as covered with hairs †." We have never been so fortunate as to meet with the leaves first mentioned by Mr BROWN, and, indeed, never saw a barren plant; but the rest we have examined, and they appear to differ considerably from each other, and not to resemble those of any known moss. Those on the summit of the perichætium are, as Mr BROWN observes, deeply divided, and terminate in remarkably long filamentous segments: indeed, unless very great care be taken in the examination, they may pass for mere bundles of long interwoven conservoid filaments. Those at the base of the perichætium are

* See GREVILLE in Wern. Trans. vol. iii. p. 447.

† Linn. Trans. vol. xii. p. 533.

the most easily examined; “the lower part is strongly reticulated; the reticulations very irregular, and the bars or cellular divisions remarkable, being uniform in their diameter, which is considerable, smooth, semitransparent, and of a peculiar inflated appearance, difficult to describe or represent. Before the leaf begins to contract, the reticulations cease, and a number of conferva-like filaments are produced, which seem to be seldom if ever jointed, but are long, and generally much entangled. The colour of all the leaves is a light-green, tinged with a brown that increases in age; but the filaments are even then generally diaphanous, and exactly resemble the dark-coloured filaments that are to be met with on every specimen towards the upper part of the bulb*.”

OBS. What we have said under *Diphyscium*, equally applies to the structure of the interior of the theca of this “*Regina Muscorum*.” The only difference seems to be, that the little pillar or column which supports the sporular sac (it may almost be called a continuation of the interior of the seta) is dilated half-way up, into a small hollow globe. The economy of this part we have not been able to conjecture, nor have other botanists been more successful. Our observations relative to the peristome of *Diphyscium* also apply here; in that genus, however, it is strictly simple; in *Buxbaumia* it is double. The outer one has been already described as composed of numerous filiform cilia; these cilia do not, however, seem to be free to their base, but to be more or less laterally connected, so much so, indeed, as to form a sort of *corona*, equal in height to the inner peristome; “*eminet ab inde coronæ imago, e numero-*

* GREVILLE, WERN. Trans. vol. iii. p. 445.

sissimis succulentis processibus exstructa, quos dentibus quasi adglutinatos reperi, cum horum unum alterumque de sua sede solverem." With this account given by WEBER and MOHR*, our examinations induce us to coincide, and to differ somewhat from Dr HOOKER, who, in the *Flora Londinensis*, seems to describe and figure them as free to the base,—a circumstance also supported by Mr BROWN, who remarks, "The peristomium of *Buxbaumia*, originating entirely from the outer membrane, may, though consisting of several, and even of dissimilar, series, be regarded as analogous to that portion of the pencil of *Dawsonia*, which arises from the same part of the capsule. This analogy is suggested by Mr HOOKER, and is confirmed by a circumstance that he does not seem to have noticed, namely, that his outer peristomium, the corona of HEDWIG, consists of a double series of cilia. The number of cilia in each series exceeds sixteen, but hardly amounts to thirty-two; it probably, however, corresponds with that of the plicæ in the membranaceous peristomium †." Though *Buxbaumia* resembles *Dawsonia* in the similarity of the origin of the cilia, the cilia themselves only resemble each other in being destitute of articulation.

BUXBAUM, in his *Centuria II.* p. 8, described the theca of this moss as bivalve; —"Huic insidet capitulum recurvum, ex duabus valvis compositum secundum longitudinem dehiscentibus, quarum inferior teres, superior vero magnis depressa in unquem brevem desinit." Upon this passage there is the following remark, in the *Amœnitates Academicæ* ‡: "Dum BUXBAUMIUS dicit capitulum findi vel secundum longitudinem dehiscere, a vero maxime deflectit;

* Handbuch, p. 382.

† Linn. Trans. vol. vol. xii. p. 582.

‡ Vol. v. p. 88.

nam tenuior illa membrana lateralis a crassiore nec finditur, nec dirumpitur; eadem ratione capitulum quoque depinxit gibbosius ad basin, quod tamen longe aliter se habet." Even Dr HOOKER seems to think that BUXBAUM mistook "a line, formed by the shrinking of the capsule, for the suture of the valves." BUXBAUM, however, was partly right; for though the theca cannot be said to be really bivalve, yet the upper portion actually separates from the lower, and falls to the ground, while the plant is undecayed. Among the specimens which the late Mr JOHN STEWART was so fortunate as to find in Selkirkshire, were many thecæ in this condition; two of these we have before us, and find that the upper membranaceous portion is completely gone*, without the least apparent laceration, and the *unruptured* sporular sac is lying in the cavity of the remaining half. This fact is extremely curious. As the mouth of the theca in this moss is so strongly fortified, and as the inner, conical, membranaceous peristome shrinks without being deciduous, and consequently closes the orifice,—may not the above apparent valvular structure be a wise provision for the more complete dispersion of the spores?

We have already noticed that this plant is really possessed of leaves, though so minute as to escape the naked eye. Of that part on which they are found, BUXBAUM observes, "Hic, omnibus destitutus foliis, ex basi rotunda villosa," &c. In the *Amœn. Academicæ* the base is called "Tuberculum subovatum, vestitum tomento-ferrugineo, minime repens," &c. The curious character given by MICHELI, "Muscus nanus tuberosa radice, foliis juniperinis, tenuissime serratis capitulo magno ovato ventricosissimo; calyp-

* Vide *Edinb. Phil. Journ.* vol. ii. p. 377.

tra tomentosa*," is generally understood to have been occasioned by receiving a species of *Polytrichum* along with *Buxbaumia*. DE CANDOLLE describes it as possessing "un faisceau de poils courts et serrés au lieu de feuilles†;" and Dr HOOKER, "Perichætium in terram parte immersum et radices tomentosas emittens, ovato-oblongum, bulbiforme, villis nigricantibus, brevibus, strictis, varieque intertextis obtectum‡." It would be easy to multiply quotations to prove, that whatever light this part of *Buxbaumia* was regarded, no one ever thought it was covered with true leaves. The illustrious HALLER, indeed, made a near approach in saying, "Ipse, cinctus foliaceo quasi involucro, emittit durum, purpureum, pediculum ||," &c. It was reserved, however, for our countrymen, Mr BROWN, and the late Mr J. STEWART, lecturer on Botany in this city, clearly to ascertain their existence, and describe their true structure. The latter gentleman noticed them particularly in his lectures on Cryptogamic Botany in the commencement of the winter of 1818-19, and read an account of them some time afterwards to the Wernerian Society §. Mr BROWN also mentioned them in one of his admirable papers on Muscology, read before the Linnean Society April 6. 1819; and states, that he had "lately ascertained" their existence. In consequence of the lamented death of Mr STEWART, it is now impossible to ascertain to whom the precedence in this discovery is due; but both assuredly are entitled to equal merit.

* Nov. Gen. Pl. p. 109. No. 13.

† Fl. Franc. ed. 6. v. ii. p. 513.

‡ Fl. Lond.

|| Enum. Stirp. Helvet, p. 10.

§ Edin. Phil. Journ. vol. ii. p. 377. See also Edin. Encycl. art. *Musci*.

HAB. This extraordinary moss is thinly scattered through the forests and heathy parts of middle and northern Europe, but is more common in North America. Its natural habit appears to be gregarious; at the same time, and especially in this country, it sometimes loses that character. Its *duration* has usually been thought annual from the time of LINNÆUS to the present; Mr STEWART, however, finding plants in different and opposite stages of growth arising from the same perichætium, was induced to consider it as perennial; and we agree with him in thinking it biennial at the least*. In Britain, since its first discovery by Dr HOOKER, at Sprowston, near Norwich, it has been found by Mr E. J. MAUGHAN, at Rosslin, near Edinburgh; by Mr JACKSON, near Aberdeen; by Dr WADE, at Killarney, in Ireland; by Mr J. STEWART, at Waddenshope-rig, near Peebles; and by one of the authors of the present paper, on the Hill of Dungloe, in Kinross-shire †.

HIST. The first discoverer of this singular plant, was “the modest” BUXBAUM, who found it on the banks of the river Wolga, not far from Astracan, and published it in his *Centuria*, but without generic or specific name. He states in his description, that he felt a desire to name it after his father, but was afraid of derision; “sed venit mihi in mentem vulpes, qui deridebatur ab aliis, quod uvas non pro se, sed pro ægrota posceret matre.” His character is very brief: “*Muscus capillaceus aphyllus, capitulo crasso bivalvi.*” MICHELI, from specimens received from MONTIUS, and gathered in Italy, also gave afterwards a

* Edin. Phil. Journ. vol. ii. p. 377. and Wern. Trans. vol. iii. p. 443.

† At this station, as well as the Irish one, only a single specimen has been hitherto found; and from all the other habitats it has entirely vanished, except from Mr STEWART'S.

short definition, but appears to have described in it the leaves and calyptra of some *Polytrichum*. DILLENIIUS, who also received specimens from MONTIUS, detected MICHELI's error, and, in the *Historia Muscorum*, added a few observations; but in the Appendix to that work (p. 554.), we find a much fuller notice, drawn up from the plants transmitted by OLAV. CELSIUS. HALLER, in his "Enumeratio methodica Stirpium Helvetiæ indigenarum," first bestowed on it the name of *Buxbaumia*, a name which FABRICIUS changed to *Hippopodium*, from the shape of the theca; but LINNÆUS and SCHMIEDEL restored the one given by HALLER.

So far it had been considered a moss. HALLER, however, in the first edition of his *Enumeratio*, mentions it as a fungus: "Character fere *Clathroidis*, planta ambigens inter id genus plantarum, et *Clavarias*. Testam habet *Clathroidis Micheliani*, et spongiosum reticulum. Sed vita perennis, et natura durior est, atque reticulum in vacuas areolas non resolvitur."—DILLENIIUS, in his Appendix, seems also to doubt whether it be not a fungus: "Pro musco faciunt textura pediculorum, color eorum et capitulorum spadiceus splendens, sed præcipue opercula transversim obscedentia; fungum arguunt figura capitulorum, pulvis similior *Bovistæ*, quam farina capitulorum muscorum, et quod nec calyptra, nec folia ulla adsunt, sed basis mucida villosa. Color pediculis et capitulis erat fuscus et spadiceus, sed superficies non splendebat. Villebatur primum Musci et speciatim Lichenastri species, sed cum ex muscis crustaceis æque ac herbaceis, putrescentibus enasci observarem, Bovistam credidi. Qui nascentem videbunt, utrum fungus an muscus sit planta illa a BUXBAUMIO primum observata, decernere poterunt."—LINNÆUS, in his *Species Plantarum*, did not venture to arrange it among any of the well known plants; and, in the *Flora Suecica*, it is

inserted in an Appendix, being referable by him to neither order nor genus. “*Buxbaumia* vero usque ad hunc diem in obscura latuit; adeo ut dum *N. D. Prases* in speciebus suis plantarum cognita, facile omnes enumeraverit plantas usque ad minimos muscos, *Buxbaumia* agmini illorum accedere non potuit; cumque tam scientifice et ornata plantas omnes patrias detexit atque locavit, *Buxbaumia* in appendice ad Floram Suecicam venire debuit plantæ instar, nec ad genus nec ordinem relatæ*.”—Lastly, GLEDITSCH, in his *Methodus Fungorum*, mentions it, and has the following note, under the genus *Stemonitis*. “*Buxbaumia*, HALL. Enum. Helvet. p. 10, *Sphærocephalus* ejusd. p. 9, et *Clathroides* MICHELII, *N. Pl. G.* 214. tab. 94. ut conferenti patebit, caractere generico parum differunt. *Buxbaumia* igitur recte conjungantur, nec ne? et quæ sit negativæ sententiæ ratio, quæritur? *Buxbaumia* vero (Observat. HALL. docente) et *Stemonitis* in methodo nostro fungorum genera inter *Clathrum* et *Lycoperdon* media constituunt.”

But of these old speculations we have already said enough. The plant has been described by HEDWIG, and all following authors, as a moss; and, with the exception of PALISSOT, who calls it *Saccophorus*, all have retained HALLER's name of *Buxbaumia*.

PLATE III.

Fig. 13. Plants of *Buxbaumia aphylla*, natural size, in different stages of growth.

14. A theca with the operculum.

15. A calyptra.

16. Operculum.

* Amœn. Acad. vol. v. p. 79.

17. The peristome and mouth of the theca; shewing the crenated margin of the theca,—the *outer* peristome composed of ciliæ (which are usually more or less injured in removing the operculum),—and the *inner* conical membranaceous peristome.
 18. A mature theca divided, and exhibiting the same parts as in the corresponding figure of *Diphyscium*, the only difference being in the small pillar which supports the sporular sac and columella. It is here dilated into a little hollow globe, which nearly fills up the passage from the theca to the apophysis, and is again contracted and continued down to the base of the apophysis.
 19. A sectional view of the two perichætia, the mouth of the theca, the summit of the sporular sac, and that part of the columella which is above the line at which the sporular sac is attached to it.
 20. A leaf taken from near the base of the perichætium.
 21. The root divided longitudinally.
 22. The little pillar which supports the sporular sac removed.
 23. Sporules.
- All the figures, except the first, are more or less magnified.

V.—*Register of the Weather at Corfu, during the Months of August, September, October, and November, 1821.*

By MATHEW MILLER, Esq. Lieutenant in the King's own Light Infantry*.

(*Read 17th May 1823.*)

To Professor JAMESON.

Edinburgh, 26th February 1823.

DEAR SIR,

I SEND you inclosed the registers of the state of the weather, and of the thermometer, ADIE's sympiesometer, and LESLIE's hygrometer, kept by me at Corfu, during the months of August, September, October, and November, 1821. The first column, on the left, contains the days of the month,—the next, the time of observation,—the three next, the thermometer, sympiesometer, and hygrometer,—and, lastly, the observations on the wind and weather for the day.

* It is with feelings of deep sorrow we announce the sudden death of the accomplished author of this memoir. The Society, by the death of Mr MILLER, loses an intelligent and active member, and the army an officer of high promise.—*Sept. 1823.*

ADIE's sympiesometer I found most useful, and, I may mention, that I always found it correspond with a mercur-barometer kept in the garrison-library, although the sympiesometer always stood about an inch higher than the mercury, consequently 30.00 must be understood to represent 29.00 by the register. LESLIE's hygrometer has explained some of the phenomena attending the Sirrocco wind, which is the SW. and SE., but more particularly the SW. winds. You will observe by the register the extreme moisture of all the south winds, and the no less remarkable dryness of the north winds.

The extreme moisture of the south winds, and the very frequent appearance of sheet-lightning during their continuance, seems to indicate their being highly electrical; and the fact, that meat will not cure, wine keep if bottled, or paint dry, during a Sirrocco, I think favours the supposition (not to speak of its very unpleasant effects on all living beings, such as are invalids particularly), that its great moisture alone could not produce all those effects. I regret having no means of making any experiments on its electrical properties, but hope on my return to do so.

I am, &c.

M. MILLER.

P. S.—I may mention that, according to the best observations, Corfu is in Lat. $39^{\circ} 38' 20''$ N., and Long. $17^{\circ} 55' 50''$ E.

TABLE FOR AUGUST 1821.

DAY.	TIME.	THERMOMETER.	SYMPSON'S THERMOMETER.	LESLIE'S HYGROMETER.	OBSERVATIONS.	
1	5 a. m.	77°	30,18	45°	Clear and sunshine all day. Wind light from NE.	
	Noon.	81	30,12	65		
	3 p. m.	81 ¹ / ₈	30,13	65		
	10 p. m.	78	30,30	47		
2	5 a. m.	76	30,46	25	Light wind from the SE. Sunshine. At noon wind changed to NW. Variable at three, S.E., when, in a few minutes, the hygrometer fell to 40°.	
	Noon.	81	30,40	75		
	3 p. m.	83	30,30	79		
	10 p. m.	79	30,33	39		
3	5 a. m.	76	30,46	30	Light SE. wind at ten in the morning; changed to NE.; and, about six in the evening, to SE.	
	Noon.	81	30,28	39		
	3 p. m.	84	30,17	72		
	10 p. m.	79	30,15	29		
4	5 a. m.	77	30,27	12	Clear and sunshine. Light S.SE. wind till ten in the morning, when it changed to SE.	
	Noon.	82	30,18	50		
	3 p. m.	85	30,03	55		
	10 p. m.	80	30,12	20		
5	5 a. m.	77	30,24	5	Light S.SE. wind in the morning; changed to E. about 2 p. m. Clear and sunshine all day.	
	Noon.	84	30,06	27		
	3 p. m.	86	30,02	62		
	10 p. m.	82	30,25	30		
6	5 a. m.	78	30,21	9	Clear, light S.SE. wind; changed to E. about 2 p. m.	
	Noon.	83	30,05	34		
	3 p. m.	85	29,99	48		
	10 p. m.	82	30,03	15		
7	5 a. m.	78	30,07	5	Little or no wind from S.; changed to SE. about 2 p. m.; clear all day.	
	Noon.	83	29,97	24		
	3 p. m.	85	29,83	35		
	10 p. m.	80	29,99	25		
8	Noon.	82	29,83	24	Wind E.SE all day. Clear and sunshine.	
	3 p. m.	86	29,79	36		
	10 p. m.	81	29,99	20		
	5 a. m.	78	30,05	8		
9	Noon.	83	29,79	25	Clear all day. Wind SE.	
	10 p. m.	81	29,89	26		
	5 a. m.	78	30,08	9		Clear and sunshine. Wind SE.; changed to E. about 2 p. m.; and to S. about 6 evening.
	Noon.	84	29,91	26		
3 p. m.	87	29,89	50			
10 p. m.	78	30,07	15			
11	5 a. m.	77	30,09	12	Clear and sunshine. Wind SE. till 2 p. m., when it changed to W., and raised the hygrometer instantly from 28° to 53°; at 6 p. m. changed to S.	
	Noon.	83	29,93	27		
	3 p. m.	86	29,85	53		
	10 p. m.	81	29,90	21		
12	5 a. m.	79	30,08	9	Clear and sunshine all day, with SE. wind in the morning, till 3 p. m., when wind changed SW.	
	Noon.	84	29,91	29		
	7 p. m.	87	29,81	35		
	10 p. m.	82	29,94	11		

TABLE FOR AUGUST 1821,—Continued.

DAY.	TIME.	THERMOMETER.	SYMPSON'S THERMOMETER.	LESLIE'S HYGROMETER.	OBSERVATIONS.
3	5 a. m.	81°	30,01	13°	Cloudy and sunshine. Wind SW. all day.
	Noon.	84	29,93	31	
	3 p. m.	85	29,84	38	
	10 p. m.	78	30,20	28	
14	5 a. m.	81	30,43	55	Morning cloudy. High wind from N; changed to NW. about 2 p. m.; rather squally.
	Noon.	82	29,96	63	
	10 p. m.	77	30,02	28	
15	9 a. m.	77	30,13	35	Clear and sunshine, with high wind from N., and a few white clouds. Very heavy rain after 2 p. m. In evening fair.
	Noon.	78	30,14	38	
	3 p. m.	79	30,05	45	
	10 p. m.	75	30,23	25	
16	9 a. m.	77	30,24	28	Morning. Sunshine, with clouds. Overcast about 10 a. m. Wind SSW.; changed to NW., with very heavy rain and thunder.
	Noon.	75	30,23	15	
	3 p. m.	74	30,23	15	
	10 p. m.	73	30,30	17	
17	9 a. m.	71	30,31	13	Rain during night. Fair after 9 in morning. Wind N. in morning; changed to NE. about 10 a. m. Cloudy at 3 p. m. High SE. wind, with rain and thunder.
	Noon.	74	30,17	25	
	3 p. m.	74	30,53	20	
	10 p. m.	72	30,19	18	
18	9 a. m.	70	30,26	14	Morning cloudy. Clear all day, with high E. wind. Began to rain about 5 p. m., and continued raining all night.
	Noon.	74	30,18	25	
	3 p. m.	75	30,11	30	
	10 p. m.	71	30,23	14	
19	9 a. m.	72	30,35	13	Wind SE. Cloudy. Partial rain. Severe storm of thunder about 3 p. m. Evening cloudy. Great deal of sheet lightning in the evening.
	Noon.	73	30,31	22	
	3 p. m.	75	30,26	17	
	10 p. m.	72	30,42	15	
20	9 p. m.	73	30,43	18	SE. wind. Clear and sunshine. A little rain and thunder at 4 p. m. Evening fine.
	Noon.	76	30,38	26	
	3 p. m.	78	30,20	27	
	10 p. m.	77	30,47	20	
21	9 a. m.	76	30,51	26	Clear and sunshine. Wind NE.; changed to SE. about 4 p. m. Evening cloudy, and a good deal of sheet lightning.
	Noon.	79	30,43	52	
	3 p. m.	81	30,28	45	
	10 p. m.	77	30,47	20	
22	9 a. m.	78	30,38	25	Clear and sunshine. Wind SE.; changed about noon to NW., with a few clouds and sheet lightning in evening.
	Noon.	80	30,26	36	
	3 p. m.	81	30,15	57	
	10 p. m.	77	30,24	28	
23	9 a. m.	77	30,23	26	Clear and sunshine. Wind NW.; changed to SW. about 11 a. m., and to SE. about 2 p. m. Evening cloudy, with sheet lightning.
	Noon.	80	30,14	33	
	3 p. m.	82	30,03	41	
	10 p. m.	76	30,21	24	
24	9 a. m.	77	30,31	30	NW. wind. Clear and sunshine at 2 p. m. Wind changed to SE. Evening cloudy.
	Noon.	81	30,18	43	
	3 p. m.	83	30,20	32	
	10 p. m.	78	30,33	14	

TABLE FOR SEPTEMBER,—*Continued.*

DAY.	TIME.	THERMOMETER.	SYMPHYSIOMETER.	LESLIE'S HYGROMETER.	OBSERVATIONS.
25	9 a. m.	78°	30,34	21°	Sunshine. A few clouds. Wind light SW., and changed NE. about 2 p. m.
	Noon.	79	30,31	33	
	3 p. m.	80	30,26	24	
	10 p. m.	78	30,33	19	
26	9 a. m.	78	30,35	23	Morning overcast and thunder. Wind NW. Clear and sunshine from 11 a. m. till 1 p. m., when wind changed NE., with rain and thunder.
	Noon.	77	30,36	35	
	3 p. m.	76	30,36	34	
	10 p. m.	78	30,40	22	
27	9 a. m.	76	30,40	23	Clear and sunshine. Wind N. E. till noon; changed NW.; rather squally.
	Noon.	78	30,31	34	
	3 p. m.	81	30,21	53	
	10 p. m.	77	30,33	35	
28	9 a. m.	76	30,40	23	Clear and sunshine. Little or no wind from SE.; changed to NE. about 2 p. m.
	Noon.	79	30,32	27	
	3 p. m.	81	30,21	53	
	10 p. m.	77	30,33	35	
29	9 a. m.	78	30,37	21	Clear and sunshine. Light SW. wind; changed about 11 a. m. to NW.
	Noon.	80	30,31	44	
	3 p. m.	82	30,21	59	
	10 p. m.	79	30,26	25	
30	9 a. m.	78	30,37	27	Clear and sunshine. Wind SE.; changed to NW. about 1 p. m. and NE. about 2 p. m.
	Noon.	80	30,25	46	
	3 p. m.	82	30,21	65	
	10 p. m.	79	30,30	17	
31	9 a. m.	79	30,35	10	Clear and sunshine. Wind SW. all day.
	Noon.	80	30,28	29	
	3 p. m.	81	30,16	37	
	10 p. m.	79	30,12	20	

TABLE FOR SEPTEMBER 1821.

DAY.	TIME.	THERMOME- TER.	SYMPHISOME- TER.	LESLIE'S HY- GROMETER.	OBSERVATIONS.
1	9 a. m.	80°	30,16	23°	Clear and sunshine. Wind SE. till 2 p. m., when it changed to N.NW. Rather squally at 4 p. m. Observed Hygrometer stand at 76°.
	Noon.	80	30,08	27	
	3 p. m.	82	30,02	53	
	10 p. m.	79	30,09	28	
2	9 a. m.	78	30,05	24	Morning overcast. Wind SE.; changed at 11 a. m. to NE. Squally. Wind less, and evening clear.
	Noon.	79	30,04	60	
	3 p. m.	79	30,01	45	
3	10 p. m.	76	30,22	39	Clear and sunshine all day, with N. wind in morning, till 1 p. m., when it changed NE. Very high wind till 3 p. m.
	9 a. m.	77	30,22	35	
	Noon.	78	30,14	57	
	3 p. m.	79	30,09	63	
4	10 p. m.	75	30,22	39	Light NW. wind in morning; changed to NE. about 11 a. m. Clear and sunshine all day.
	9 a. m.	75	30,30	45	
	Noon.	78	30,22	60	
	3 p. m.	74	30,17	76	
5	10 p. m.	75	30,38	46	Clear and sunshine all day, with NE. wind. Rather squally about 3 p. m.
	9 a. m.	76	30,46	49	
	Noon.	77	30,44	65	
	3 p. m.	78	30,39	72	
6	10 p. m.	74	30,54	43	Clear and sunshine, Wind E.NE. all day.
	9 a. m.	74	30,67	42	
	Noon.	77	30,57	41	
	3 p. m.	79	30,43	55	
7	10 p. m.	75	30,56	39	Clear and sunshine, Wind N. all day; changed SE. at 6 p. m.
	9 a. m.	76	30,53	45	
	Noon.	79	30,43	63	
	3 p. m.	80	30,30	77	
8	10 p. m.	77	30,35	37	Clear and sunshine all day. Wind SW. till 2 p. m., when it changed to NW.
	9 a. m.	76	30,44	38	
	Noon.	78	38,38	50	
	3 p. m.	79	30,27	74	
9	10 p. m.	77	30,42	40	Clear and sunshine. SW. wind in morning. At 2 p. m. changed NE.
	9 a. m.	76	30,46	33	
	Noon.	78	30,39	38	
	3 p. m.	79	30,35	72	
10	10 p. m.				Thunder and rain in the morning. Wind variable from the S. Wind SE. after 2 p. m.
	9 a. m.				
	Noon.	77	30,42	26	
	3 p. m.	78	30,38	30	
11	10 p. m.	76	30,44	10	Wind S.SE. all day. Clear and sunshine all day.
	9 a. m.	76	30,38	17	
	Noon.	77	30,34	30	
	3 p. m.	79	30,33	42	
	10 p. m.	75	30,35	19	

TABLE FOR SEPTEMBER 1821,—Continued.

DAY.	TIME.	THERMOMETER.	SYMESOMETER.	LESLIE'S HYGROMETER.	OBSERVATIONS.
12	9 a. m.	75°	30,35	15°	Clear and sunshine all day. Wind SE. till 2 p. m.; when it changed to SW.
	Noon.	76	30,32	25	
	3 p. m.	77	30,33	36	
	10 p. m.	74	30,47	20	
13	9 a. m.	75	30,43	27	Morning overcast, and a little rain. Cloudy all day. Wind SW. till 2 p. m., when it changed to N.NW.
	Noon.	75	30,32	37	
	3 p. m.	77	30,26	53	
14	10 p. m.	74	30,31	21	Heavy rain and high SW. wind. Afternoon fair. Wind W. Sheet lighting at night.
	9 a. m.	75	30,04	25	
	Noon.	76	30,00	34	
	3 p. m.	75	29,99	42	
15	10 p. m.	72	30,23	18	Cloudy. Wind NW. about 2 p. m.; changed SW. Partial rain.
	9 a. m.	69	30,41	44	
	Noon.	70	30,39	40	
	3 p. m.	70	30,44	25	
16	10 p. m.	70	30,38	23	Wind high from N.NW.; changed SE. about 10 a. m. Heavy rain all day.
	9 a. m.	70	30,47	42	
	Noon.	70	30,49	23	
	3 p. m.	71	30,52	29	
17	10 p. m.	70	30,61	13	Clear and sunshine. Wind S.SW. till 11 a. m., when it changed W.
	9 a. m.	71	30,70	23	
	Noon.	71	30,64	40	
	3 p. m.	75	30,52	54	
18	10 p. m.	71	30,57	29	Clear and sunshine. Wind S.SW. till 11 a. m., when it changed to W.
	9 a. m.	72	30,48	27	
	Noon.	73	30,36	37	
	3 p. m.	75	30,23	45	
19	10 p. m.	72	30,31	25	Clear and sunshine. Wind E.SE all day.
	9 a. m.	72	30,33	26	
	Noon.	74	30,24	40	
	3 p. m.	73	30,22	7	
20	10 p. m.	72	30,30	23	Clear and sunshine. Wind SW. till 2 p. m., when it changed to S.
	9 a. m.	73	30,26	15	
	Noon.	75	30,20	42	
	3 p. m.	77	30,13	50	
21	10 p. m.	75	30,31	13	Clear and sunshine. Wind SE; ; changed to NW. about 2 p. m.
	9 a. m.	75	30,49	21	
	Noon.	78	30,37	33	
	3 p. m.	79	30,32	56	
22	10 p. m.	75	30,51	18	Clear and sunshine. Wind W. all day.
	9 a. m.	75	30,62	26	
	Noon.	76	30,58	39	
	3 p. m.	78	30,46	47	
	10 p. m.	75	30,56	23	

TABLE FOR SEPTEMBER 1821,—Continued.

DAY.	TIME.	THERMOMETER.	SYMPSONETER.	LESLIE'S HYGROMETER.	OBSERVATIONS.
23	9 a. m.	74°	30,53	17°	Cloudy. Wind S.S.E. all day.
	Noon.	76	30,57	33	
	3 p. m.	78	30,43	37	
	10 p. m.	75	30,56	16	
24	Noon.	77	30,53	24	Cloudy. Wind S.S.W.; changed at 11 a. m. to W.
	3 p. m.	78	30,43	40	
	10 p. m.	75	30,50	27	
25	9 a. m.	75	30,54	33	Cloudy. Wind S.; changed at 11 a. m. to N.W., with violent rain and thunder. Fair at 3 p. m.
	Noon.	76	30,53	34	
	3 p. m.	74	30,54	7	
	10 p. m.	73	30,58	8	
26	9 a. m.	73	30,57	17	Clear. Wind SE. all day. Sheet lightning in the evening.
	Noon.	73	30,54	25	
	3 p. m.	75	30,44	42	
	10 p. m.	74	30,52	14	
27	9 a. m.	73	30,51	21	Clear in morning. Wind S.; changed to a high N.N.W. wind about 2 p. m. Evening cloudy.
	Noon.	74	30,46	31	
	3 p. m.	74	30,39	65	
	10 p. m.	72	30,53	42	
28	9 a. m.	71	30,60	39	Clear and sunshine all day, with high N.N.W. wind.
	Noon.	70	30,60	57	
	3 p. m.	73	30,50	67	
	10 p. m.	70	30,65	33	
29	9 a. m.	71	30,75	38	Rather cloudy. Wind N.W. in morning; changed to S.S.E. about 2 p. m.
	Noon.	72	30,67	40	
	3 p. m.	71	30,61	27	
30	9 a. m.	71	30,49	27	Cloudy all day. Wind SE. Partial rain. High wind and great deal of sheet lightning at night.
	Noon.	72	30,67	40	
	3 p. m.	72	30,32	18	
	10 p. m.	72	30,17	11	

TABLE FOR OCTOBER 1821.

DAY.	TIME.	THERMOMETER.	SYMPSONETER.	LESLIE'S HYGROMETER.	OBSERVATIONS.
1.	9 a. m.	68°	30,33	36°	Rain in morning. Wind NE.; variable. Fair and clear after 10 a. m. This morning, a most violent storm of thunder.
	Noon.	68	30,45	44	
	3 p. m.	67	30,56	34	
	10 p. m.	64	30,67	24	
2.	9 a. m.	65	30,75	22	Rained all day. Wind high from NNW.
	Noon.	66	30,72	45	
	3 p. m.	66	30,68	55	
	10 p. m.	65	30,79	25	
3.	9 a. m.	67	30,83	33	Clear and sunshine. Wind ENE. till 2 p. m., when it blew hard from NNE.
	Noon.	67	30,79	39	
	3 p. m.	69	30,70	65	
	10 p. m.	66	30,81	44	
4.	9 a. m.	67	30,82	52	Clear and sunshine. High NNE. wind all day.
	Noon.	69	30,70	78	
	3 p. m.	70	30,61	80	
	10 p. m.	67	30,65	51	
5.	9 a. m.	67	30,69	31	Clear and sunshine, Wind NE. all day.
	Noon.	68	30,67	52	
	3 p. m.	69	30,59	65	
	10 p. m.	65	30,70	34	
6.	9 a. m.	65	30,90	34	Clear and sunshine. Light S.SE. wind all day.
	Noon.	68	30,76	39	
	3 p. m.	69	30,80	44	
	10 p. m.	67	30,99	30	
7.	9 a. m.	68	31,10	23	Clear and sunshine, Light SSE. wind till 2 p. m., when it changed to N.NW.
	Noon.	69	31,03	40	
	3 p. m.	71	31,00	49	
	10 p. m.	68	31,07	18	
8.	9 a. m.	68	31,03	22	Clear and sunshine, with S.SE. wind till 2 p. m., when it changed to E.
	Noon.	70	30,96	35	
	3 p. m.	71	30,83	42	
	10 p. m.	67	30,86	28	
9.	9 a. m.	67	30,88	19	Morning clear. Overcast during the day, with S.SE. wind till 2 p. m., when it changed to N.NW.
	Noon.	70	30,86	36	
	3 p. m.	72	30,72	60	
	10 p. m.	68	30,94	13	
10.	9 a. m.	69	30,93	25	Clear and sunshine. Wind E.SE. all day. Rather squally in the afternoon.
	Noon.	70	30,88	42	
	3 p. m.	71	30,74	63	
	10 p. m.	68	30,75	34	
11.	9 a. m.	68	30,80	43	Morning cloudy. Wind SE.; changed to S. about noon; blew hard; and rained all day from 2 p. m.
	Noon.	69	30,82	42	
	3 p. m.	69	30,69	25	
	10 p. m.	67	30,79	17	

TABLE FOR OCTOBER 1821,—*Continued.*

DAY.	TIME.	THERMOMETER.	SYMPICOMETR.	LESLIE'S HYGROMETER.	OBSERVATIONS.
12	9 a. m.	67°	30,96	11°	Thunder in morning, and heavy rain from 7 a. m. till 1 p. m. Wind E. and W.; variable.
	Noon.	66	30,96	13	
	3 p. m.	70	30,79	25	
	10 p. m.	69	30,86	23	
13	9 a. m.	70	30,88	28	Clear and sunshine all day. Wind S.S.E. all day.
	Noon.	71	30,84	27	
	3 p. m.	72	30,82	30	
	10 p. m.	69	30,91	7	
14	9 a. m.	69	30,94	12	Clear and sunshine. Wind light S. E. all day.
	Noon.	70	30,86	26	
	3 p. m.	71	30,81	23	
	10 p. m.	68	30,86	14	
15	9 a. m.	69	30,84	18	Clear and sunshine. Wind SE. all day.
	Noon.	69	30,77	29	
	3 p. m.	70	30,70	27	
	10 p. m.	67	30,68	12	
16	9 a. m.	66	30,64	27	Rain in morning. Fair and clear from 10 a. m. Wind variable from SE. all day.
	Noon.	68	30,62	37	
	3 p. m.	69	30,50	38	
	10 p. m.	68	30,47	36	
17	9 a. m.	70	30,40	27	Rained all day. Wind S.; variable.
	Noon.	70	30,42	27	
	3 p. m.	68	30,50	9	
	10 p. m.	64	30,54	6	
18	9 a. m.	68	30,63	16	Clear and sunshine. Wind S. till 2 p. m. when it changed to N.N.W.
	Noon.	69	30,61	23	
	3 p. m.	70	30,57	42	
19	10 p. m.	62	30,56	19	Wind E.; variable. Rained all day, with thunder.
	9 a. m.	63	30,57	22	
	Noon.	64	30,56	19	
	3 p. m.	64	30,48	10	
20	10 p. m.	63	30,45	5	Morning fair. Rained all afternoon. Wind S.S.E.
	9 a. m.	65	30,45	16	
	Noon.	67	30,40	25	
	3 p. m.	66	30,46	15	
21	10 p. m.	63	30,45	17	Rain in morning, with S. wind; changed at 2 p. m. to E.N.E., with high wind and rain.
	9 a. m.	62	30,52	15	
	Noon.	63	30,50	20	
	3 p. m.	64	30,53	12	
22	10 p. m.	62	30,60	10	Wind S, all day, with rain and thunder.
	9 a. m.	66	30,79	18	
	Noon.	68	30,71	21	
	3 p. m.	67	30,72	15	
	10 p. m.	66	30,78	20	

100 REGISTER OF THE WEATHER AT CORFU.

TABLE FOR OCTOBER 1821,—Continued.

DAY.	TIME.	THERMOMETER.	SYMPHONOMET.	LESLIE'S HYGROMETER.	OBSERVATIONS.
23	9 a. m.	66°	30,69	°	Wind S. Morning rain. 2 p. m. wind changed to S.S.E.; blew most violently. At half past 5 p. m. felt the shock of an earthquake.
	Noon.	66	30,64	22	
	3 p. m.	67	30,57	37	
	10 p. m.	64	30,62	12	
24	9 a. m.	63	30,78	13	Rain in morning. Clear and sunshine all day. Wind E.
	Noon.	64	30,81	22	
	3 p. m.	65	30,80	18	
25	10 p. m.	63	30,84	11	Morning cloudy. Partial rain. Wind S.S.W. all day. Violent thunder storm and heavy rain at 7 p. m.
	9 a. m.	64	30,75	18	
	Noon.	65	30,65	25	
	3 p. m.	64	30,66	20	
26	10 p. m.	63	30,64	10	Wind SE. Partial rain and thunder in the evening.
	9 a. m.	63	30,51	20	
	Noon.	63	30,53	15	
	3 p. m.	64	30,45	22	
27	10 p. m.	64	30,53	19	Clear and sunshine. Wind NE. all day.
	Noon.	66	30,54	30	
	3 p. m.	65	30,57	47	
28	10 p. m.	64	30,83	37	Cloudy. Wind E. A little rain in the evening.
	9 a. m.	64	31,02	28	
	Noon.	65	31,01	31	
	3 p. m.	65	31,04	42	
29	10 p. m.	64	31,16	20	Wind SE. Clear and sunshine till 5 p. m., when it rained.
	9 a. m.	65	31,12	26	
	Noon.	65	31,01	33	
	3 p. m.	64	31,06	27	
30	10 p. m.	63	31,00	24	Clear and sunshine. Wind E. by S. till sunset, when it changed to N.NE.
	9 a. m.	62	30,94	20	
	Noon.	64	30,93	36	
	3 p. m.	65	30,83	35	
31	10 p. m.	63	30,92	54	Clear and sunshine. Wind N.NE. till sunset, when it changed to SE.
	9 a. m.	61	31,06	53	
	Noon.	62	31,08	51	
	3 p. m.	64	31,03	64	
	10 p. m.	62	31,17	24	

TABLE FOR NOVEMBER 1821.

DAY.	TIME.	THERMOMETER.	SYMPHESOMETER.	LESLIE'S HYGROMETER.	OBSERVATIONS.
1	9 a. m.	61°	31,28	26°	Clear and sunshine. Wind E. and NE. all day.
	Noon.	62	31,28	34	
	3 p. m.	63	31,25	45	
	10 p. m.	61	31,86	18	
2	9 a. m.	61	30,72	19	Clear and sunshine. Wind SW. till 2 p. m., when it changed to NE. Evening cloudy, with a good deal of thunder.
	Noon.	62	30,75	26	
	3 p. m.	63	30,84	40	
3	10 p. m.	60	30,41	17	Clear and sunshine. Wind SW. but very little of it.
	9 a. m.	61	30,33	13	
	Noon.	62	30,33	23	
	3 p. m.	64	30,41	26	
4	10 p. m.	62	30,13	10	Clear and sunshine all day. Wind SE.
	9 a. m.	61	29,96	9	
	Noon.	64	30,07	12	
	3 p. m.	64	30,04	14	
5	10 p. m.	62	29,90	12	Wind SE. Cloudy, and a good deal of rain.
	9 a. m.	61	29,82	14	
	Noon.	65	29,80	14	
	3 p. m.	65	29,74	8	
6	10 p. m.	63	29,60	11	Cloudy, and very heavy rain, with thunder and high NE. wind.
	9 a. m.	63	29,54	7	
	Noon.	64	29,48	25	
	3 p. m.	64	29,47	27	
7	10 p. m.	60	29,30	15	Wind SW. in morning; changed to E. about 2 p. m. Cloudy, and partial rain all day, with the wind very high.
	9 a. m.	60	29,09	16	
	Noon.	62	29,14	19	
	3 p. m.	63	29,10	27	
8	10 p. m.	59	28,99	25	Cloudy, with NE. wind; changed to high E. wind about 2 p. m.
	9 a. m.	57	28,96	23	
	Noon.	61	28,88	30	
	3 p. m.	62	28,90	26	
9	10 p. m.	59	28,83	28	Clear and sunshine. Wind NE. all day.
	9 a. m.	58	28,82	20	
	Noon.	62	28,88	44	
	3 p. m.	62	28,87	39	
10	10 p. m.	58	28,75	30	Clear and sunshine. Wind NE. till 3 p. m., when it changed to E. Blew rather hard in the evening.
	9 a. m.	60	28,75	34	
	Noon.	61	28,78	41	
	3 p. m.	59	28,75	43	
11	10 p. m.	55	31,41	49	Clear and sunshine. Wind E., blowing hard all day.
	9 a. m.	53	31,46	21	
	Noon.	59	31,44	44	
	3 p. m.	60	31,49	48	
	10 p. m.	49	31,45	27	

TABLE FOR NOVEMBER 1821,—*Continued.*

DAY.	TIME.	THERMOMETER.	SYMPSONE-THER.	LESLIE'S HYGROMETER.	OBSERVATIONS.
12	9 a. m.	54°	31,54	32°	Clear and sunshine. Wind E. all day.
	Noon.	58	31,46	40	
	3 p. m.	60	31,49	42	
	10 p. m.	49	31,45	27	
13	9 a. m.	57	31,63	32	Clear and sunshine. Wind E. all day.
	Noon.	59	31,67	37	
	3 p. m.	58	31,64	40	
	10 p. m.	56	31,59	22	
14	9 a. m.	58	31,63	23	Clear and sunshine. Wind E. all day.
	Noon.	60	31,50	28	
	3 p. m.	59	31,53	22	
	10 p. m.	51	31,55	10	
15	9 a. m.	56	31,68	6	Clear and sunshine. Wind SE.; variable all day.
	Noon.	60	31,57	23	
	3 p. m.	59	31,51	24	
	10 p. m.	57	31,57	19	
16	9 a. m.	58	31,53	10	Wind SE. Rained all day till 4 p. m. Wind changed to NE. about 1 p. m.
	Noon.	60	31,52	19	
	3 p. m.	58	31,53	13	
	10 p. m.	53	31,53	7	
17	9 a. m.	51	31,62	3	Clear and sunshine. Wind SE. all day.
	Noon.	58	31,63	27	
	3 p. m.	58	31,59	25	
	10 p. m.	53	31,70	8	
18	9 a. m.	55	31,80	5	Light SE. wind all day. Clear and sunshine.
	Noon.	58	31,70	15	
	3 p. m.	59	31,68	25	
	10 p. m.	55	31,64	12	
19	9 a. m.	57	31,58	7	Cloudy, Partial rain. Wind SW.
	Noon.	60	31,50	20	
	3 p. m.	61	31,43	25	
	10 p. m.	55	31,49	11	
20	9 a. m.	56	31,54	4	Light SE. wind. Clear and sunshine all day.
	Noon.	60	31,50	20	
	3 p. m.	61	31,40	26	
	10 p. m.	54	31,41	7	
21	9 a. m.	58	31,46	6	Clear and sunshine. Light wind from S.SE. all day.
	Noon.	60	31,39	20	
	3 p. m.	62	31,33	25	
	10 p. m.	58	31,36	16	
22	9 a. m.	50	31,17	21	Clear and sunshine. High S.SE. wind all day.
	Noon.	62	31,35	23	
	3 p. m.	62	31,31	26	
	10 p. m.	62	31,30	20	

TABLE FOR NOVEMBER 1821,—*Continued.*

DAY.	TIME.	THERMOMETER.	SYMPSON'S THERMOMETER.	LESLIE'S HYGROMETER.	OBSERVATIONS.
23	9 a. m.	60°	31,18	17°	Wind SE. Clear and sunshine all day.
	Noon.	64	31,16	22	
	3 p. m.	64	31,12	25	
	10 p. m.	58	31,14	13	
24	9 a. m.	60	31,10	17	Wind SE. Clear and sunshine all day.
	Noon.	63	31,10	25	
	3 p. m.	61	31,22	15	
	10 p. m.	62	31,18	13	
25	9 a. m.	60	31,14	9	Morning rainy. Wind changed from SW. to NE. at 4 p. m.
	Noon.	60	31,11	11	
	3 p. m.	63	31,06	22	
	10 p. m.	61	31,08	26	
26	9 a. m.	59	31,23	4	Clear and sunshine. Wind SE. all day.
	Noon.	60	31,28	14	
	3 p. m.	63	31,18	29	
	10 p. m.	60	31,10	13	
27	9 a. m.	61	31,14	15	Clear and sunshine. Wind changed from E. to SE. about 10 a. m.
	Noon.	61	31,10	22	
	3 p. m.	63	31,16	18	
	10 p. m.	60	31,15	14	
28	9 a. m.	61	31,18	12	Wind SE. Clear and sunshine all day.
	Noon.	62	31,15	20	
	3 p. m.	63	31,12	23	
	10 p. m.	58	31,11	14	

VI.—*Additional Observations relative to the Foramen centrale of the Retina in Reptiles.*

By ROBERT KNOX, M. D.

Member of the Wernerian Natural History Society, and of the Medico-Chirurgical Society of Edinburgh.

(Read 22d November 1823.)

SINCE my first observations on the discovery of the *foramen centrale* in reptiles were written, I have had an opportunity of examining, through the kindness of Professor JAMESON, the anatomy of a large variety of the Chameleon, which had been sent to the Museum of the University by the Marchioness of Hastings. The conjecture offered by me formerly, that the *foramen centrale* would be found to exist in the eye of this animal, was now confirmed; for the whole of this very singular structure, viz. the *foramen*, and the fold of the retina, are remarkably developed in the chameleon, and actually much larger than in the human species. There extends also from the entrance of the optic nerve to the *foramen*, a fissure, which, however, is not real, but apparent: this semblance of a fissure



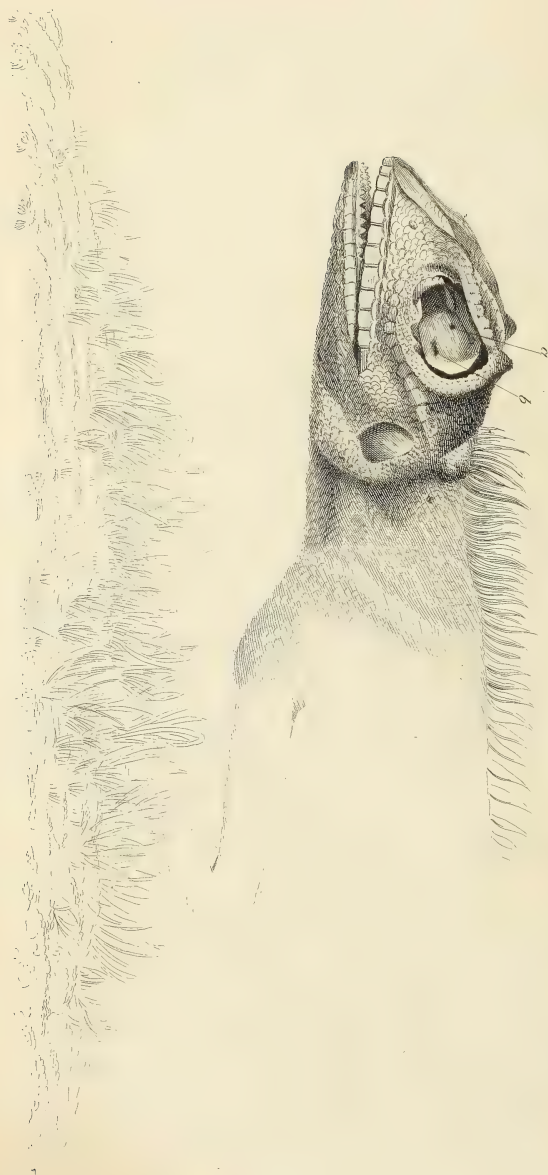
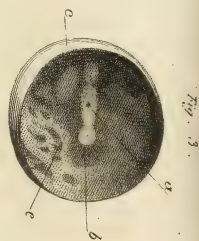
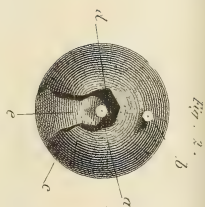

Fig. 1.



is caused by a remarkable thinness of the retina at this point. The retina around the *foramen* has adhering to it a quantity of black granulated matter, which it probably receives from the choroid.

Exactly at the point corresponding to the *foramen*, the choroid is somewhat elevated internally, whilst it transmits externally a dark-coloured membranous canal or tube to the sclerotic. This is the only point at which I have found the choroid adhering to the sclerotic in these animals.

Nothing novel is shewn by examining the *foramen centrale* under the microscope, but the structure is naturally rendered more distinct. We perceive that the *foramen* is not quite circular, but somewhat irregular in its margin, and that the actual aperture is smaller than might be otherwise supposed. This diminution in the real size of the aperture is owing to a thin semitransparent layer, proceeding from the more solid and opaque retina towards the centre of the aperture. I hope soon to be able to submit to the Society some further researches on this subject.

I ought perhaps to have added, that most of the dissections detailed in this and in my former paper announcing the discovery, were performed in the presence of numerous friends; most of the preparations are in my possession, and will be deposited in the Museum; but I have reserved a few specimens, lest any of the members of the Society, accustomed to minute research, should desire to examine the structure for themselves.

Explanation of Plate IV.

Fig. 1. Represents the head of a variety of the *Lacerta superciliosa*. The eye was dissected *in situ*; the whole dissection consists in snipping off with a pair of

very sharp scissars the anterior third of the eye-ball, including the cornea and iris: the lens and capsule of the vitreous humour must now be very carefully removed with a fine brush. I have thought it worth while to mention the mode I adopt in displaying the retina, because, by its adoption, any one, whether anatomist or not, will readily ascertain the presence or absence of this very extraordinary structure.

The black point *b*, marking the entrance of the optic nerve into the interior of the eye-ball, may readily be distinguished from the *foramen centrale* (*a*), by the little marsupium which has been left attached to the former. I regret that the drawing had not been taken from the eye of the chameleon, in which the structure is naturally so greatly magnified.

Fig. 2. The eye-ball viewed posteriorly, to shew that the transparent Point of Sœmmering is really a *foramen*. The sclerotic *c*, and choroid *d*, have been removed, leaving the retina (marked *e*), in which the *foramen* (*a*) is distinctly visible. *b*, marks the entrance of the optic nerve.

Fig. 3. The *foramen centrale*, fold, and yellow spot, as seen in the eye of apes. This latter figure is of the natural size; the others are somewhat magnified. The letters refer to the same parts as in the former figures.

EDINBURGH, }
Sept. 1. 1823. }

VII.—*Contribution to a Natural and Economical
History of the Coco-Nut Tree.*

By MR HENRY MARSHALL,

Surgeon to the Forces, and Author of Notes on the Medical Topography
and Diseases of the Interior of Ceylon.

(*Read 22d November 1823.*)

THE Coco-nut tree (*Cocos nucifera*) belongs to the class Monœcia, order Hexandria, of the Linnean classification of plants.

Stem erect, without branches, from 60 to 90 feet in height, and from one to two feet in thickness. It is marked with parallel rings from the cicatrices of the fallen leaves, about two of which separate annually. By these cicatrices or marks the age of a tree is ascertained.

The stem is crowned with a bunch of about twelve or fifteen fronds (palm-leaves), each twelve or fourteen feet long, and composed of a double row of opposite sword-shaped leaflets, in length from three to four feet; upper leaves are erect, middle horizontal, lower ones rather drooping. A single leaf closely resembles a greatly magnified ostrich-feather.

The flower is axillary, and proceeds from a large single-leaved pointed spathe, which always opens on the under surface. The spadix is spicate; each spike has towards its base one or two female flowers, the others being male. In both male and female flowers the calyx has three divisions, and the corolla three petals. The male flowers have six stamens, and the female three stigmas. Drupe oval, three-sided, about from eight to ten inches long, exterior covering smooth, interior fibrous; nut monospermous, very hard, has three unequal holes at the base closed with a black membrane; medullary part nearly half an inch thick, white, hard, commonly filled with a sweetish watery liquid. Ripe nuts are known by a succussion of the water they contain, when shaken.

A reticulated substance, resembling coarse cloth, involves the base of each leaf; it falls off before the leaf has attained a state of maturity. In Bengal, this filamentous body is supposed to harbour insects, which are destructive to the tree: on that account, it is there destroyed by fire.

The roots are slender, and very flexible: they rise separately from the bottom of the trunk, some sinking deep in the earth, while others take a horizontal direction very little under the surface. They do not penetrate an indurated soil.

The young tree bears a near resemblance to a herbaceous plant; indeed, during the whole progress of its growth it has some analogy with vegetable productions of this kind. The stalk of some species of Brassica (or Cabbage genus) consists chiefly of pith, until the plant attains a certain age, when the exterior crust of the trunk becomes ligneous, and the proportion of pith diminishes. In several respects the Coco-nut tree has a similar progress. It has no bark; the surface appears to be formed of the cicatrices, which succeed the fall of the leaves, much hardened by the

action of the air and sun. A slight wound in the central bud is fatal to the tree; but the hardened trunk is capable of bearing considerable injury with impunity.

Coco-nut trees are often struck by lightning, which frequently kills the terminal leaf-bud, and thereby occasions the death of the tree. This tree never changes the diameter it has once acquired. Should any circumstance occur capable of retarding the growth during one or more years, such as transplantation, the effect is very evident in the stem by a permanent contraction in its diameter. Immediately above these strangulated parts small roots sometimes protrude, but they seldom extend beyond a few inches. Frequently the trunk has a larger diameter at the base and top than in the middle.

The wood of the stem is composed of hard, flexible, ligneous, black fibres, united by a soft brownish pith, or cellular substance, capable of being reduced to powder. "The palms have in the interior structure of their trunks no analogy with other trees. In habit and in structure they resemble the ferns, in their blossom the grasses, and the asparagi in their mode of fructification*." All the palms have in a greater or less degree a spongy structure. The cellular substance of the *Cycas circinalis* (Sago-palm) is, in some of the islands of the eastern Archipelago, manufactured into the nutritive substance called Sago. The *Caryota urens* (Nepery tree) yields a considerable quantity of fecula, or sago; but in Ceylon this substance is not extracted, except during a period when rice is scarce. Sago is easily obtained from the interior part of the trunk of these trees. The process consists in pounding the spongy or cellular texture of the stem, and washing it with water, which is strained, to separate the ligneous fibres from the feculent

* MALTE BRUN.

substance. The process of granulating sago is not practised in Ceylon. The exterior lamina and base of the stem of a Coco-nut tree is always much harder than the interior and upper portion.

There is a palm called the King's Coco-nut, the fruit of which has a bright yellow colour, but it does not appear to be a different species from the *Cocos nucifera*. Nuts of this kind contain a great proportion of fluid, which, on account of its supposed cooling quality, is given to invalids, in preference to that of the common nuts; but they are not esteemed so good as common nuts for culinary purposes.

The nut known by the name of the Maldive Coco-nut, Coco de Mer, Zee-calappers, *Tavarcarse*, Sea Coco-nut, Double Coco-nut, *Nux medica* (*Borassus Sechellensis*), is the produce of a palm-tree, which ROCHON tells us abounds in the Isle of Palms, one of the Scychele Islands, but no where else. The fruit presents an appearance of two thighs; in other respects it is not materially different from the common coco-nut. The nuts which are occasionally found at the Maldive Islands have been carried by the current from the above-named Island.

When the Maldive traders arrive at the ports of Galle or Colombo, in Ceylon, which they usually do once a year, it is customary for them to make a present to the governor of the island, or the commanding officer of the garrison, in a very formal manner. On this occasion, I have known a small portion of the kernel of one of these nuts form part of the donation; from which it may be inferred that they imagine it to be an article of some value.

Great medicinal virtues are ascribed to this nut by the Indians, both in the prevention and cure of diseases. The venereal disease is supposed to be radically cured by it. THUNBERG says, it is deemed a sovereign remedy against

the flux, the epilepsy, and apoplexy. ROCHON tells us that it was not uncommon at one time to see them sold for upwards of L. 400 sterling each. The Emperor RODOLPHUS the Second could not procure one at the price of 4000 florins. Some of the wealthy Indians had cups made of them, which they ornamented with gold and precious stones. They are now more generally diffused than formerly, and consequently much less valuable. MALTE BRUN informs us that it has been found profitable to cultivate them in the Isle of France. Many of the mendicants in Ceylon have nuts of this kind, in which they put the provisions they receive in alms*.

The Coco-nut tree, both in regard to the variety and utility of its products, is the most interesting of the palm tribe, “the princes of the vegetable kingdom.”

The tree sometimes bears fruit in five or six years from the time it is transplanted from the seed-bed, but the produce is rarely abundant before the eighth or ninth year. It continues to yield fruit for sixty or seventy years. In good soils, and particularly during wet seasons, the tree blossoms every four or five weeks; hence there are generally fresh flowers and ripe nuts on the tree at the same time. There are commonly from five to fifteen nuts in a bunch; and, in good soils, a tree may produce from eight to twelve bunches, or from 80 to 100 nuts annually.

Coco-nut trees are sometimes much injured by various species of Scarabeus, particularly the *Scarabeus rhinoceros*. They excavate a hole of about an inch diameter in the terminal leaf-bud, and, when the leaves expand, the leaflets appear full of holes, as if they had been battered with shot of different sizes. In consequence of the injury done to the bud by this insect, the trees are sometimes killed.

* System of Geography by MALTE BRUN, vol. iv. p. 420. THUNBERG'S Travels, vol. iv. p. 209.

This species of the Palm family has its habitat in inter-tropical Asia, Australia, America, and Africa. It is by some authors said to have in ancient times been cultivated in Arabia, but NIEBUHR informs us that it is not found to the north of Mocha. Like all other equinoctial plants, the Coco-nut tree becomes less luxuriant as we approach the Tropics. At the suggestion of Mr DUNLOP, who lately, in so able a manner, superintended the work now in progress, to clear Saugur Island, at the estuary of the Hooghly, that den of tigers is likely soon to be a continued grove of coco trees. Saugur lies in N. Lat. $21^{\circ} 30'$, which is perhaps as far from the Equinoctial Line as this species of palm can be cultivated with advantage. In the neighbourhood of Lucknow, which lies in N. Lat. $26^{\circ} 24'$, the Coco-nut tree grows, but it does not produce fruit. I am informed by Dr BUCHAN, Deputy-inspector of Hospitals, who was for some time on duty in Egypt, that it is not found in that part of Africa. As the Coco tree seems to require for its perfection a mean temperature of not less than 72° FAHRENHEIT, the proper climate for it will therefore be from the Equator to the 25th parallel of latitude, and in the Equinoctial Zone to an altitude of about 2900 feet. This general statement will no doubt admit of some qualification in regard to particular situations. There may be exposed spots within its favourite climate where the fruit will not come to maturity, and warm valleys beyond the above limits where the tree will grow, and perhaps produce ripe nuts. The Coco tree occupies, therefore, a zone of 25° of latitude on both sides of the Equator, which includes nearly four-fifths of Africa, one-sixth of Asia, one-third of America, and excludes Europe. It may be remarked, that trees which grow on the immediate neighbourhood of the sea are much more luxuriant and productive than those which are planted inland or upon elevated situations. The cause of this

degeneration is not very evident, it cannot invariably be attributed to a reduction of temperature. The Coco tree is much cultivated on some parts of the east coast of America; from the river St Francisco to the Bar of Maman-guape, or from about $7^{\circ} 30'$ to 10° S. Lat., being about 94 leagues, the Brazilian coast is with few breaks planted with Coco trees. The small island of Itamaraca, which is only three leagues in length, yields annually about 360,000 nuts*. But perhaps this palm is no where so extensively cultivated as in Ceylon, and the following remarks regarding its products are intended more immediately to apply to the tree as it grows in that island. The Coco tree is cultivated both in the interior of Ceylon and along the flat country adjoining to the sea; it thrives best, however, on the coast of the south-west aspect of the island, or from Calpenteen on the north, to Dondrahead on the south. About the year 1813, it was estimated that 10,000,000 trees grew between these two points, and that since that period the number has been annually increasing. The extent of coast between Dondrahead and Calpenteen is about 184 miles; the whole circuit of the island is 754 miles. Except cinnamon, the products of the Coco tree form the chief staple commodities of Ceylon†. The Maldive Islands produce great quantities of coco-nuts; they are there said to be the price of labour. In Congo, this palm forms one of the greatest blessings in nature‡.

* KOSTER's Description of Brazil.

† I have attempted to detail the leading facts regarding the natural history of the Cinnamon tree, the mode of preparation, and trade of Cinnamon, in two papers, one of which is published in the Transactions of the Royal Society of London, for the year 1817. The other is inserted in the 10th volume of Dr THOMSON's Annals of Philosophy.

‡ System of Geography, by MALTE BRUN, vol. iv. p. 298.

It does not appear that the coco-tree is nearly as much cultivated in the West India islands as in the East. Mr STEWART, in his account of Jamaica, says, however, that "On some estates groves of them are planted, and an oil extracted from them to light the works during crop-time. Occasionally the nuts are served out to the slaves as an article of food."

In many places along the coast coco trees thrive well upon the sandy soil near to the sea, where hardly any other plant will vegetate. Those coco groves, through which the eye can reach for a great extent, intermixed with the huts of the natives, composed entirely of coco leaves, form a very picturesque object. When the trees are full grown, the bare trunks rise like columns of from 60 to 90 feet in height, while the horizontal pinnated foliage interlace, by which means a grove resembles the long aisles and Gothic arches of a cathedral; above these arches a profusion of fine leafy plumes rise from the centre of the trees, and project almost perpendicularly towards the sky, thereby adding greatly to the beauty and variety of the prospect. About twenty years since, the Colonial Government of Ceylon had it in contemplation to impose a tax upon coco trees, but, in consequence of the strongly marked aversion of the people to such a measure, the plan was abandoned. It is not unusual, however, for palm trees to be taxed directly, instead of indirectly, upon the products, as in Ceylon. On the Malabar coast, coco-nuts pay a land-tax of half a *fanam* for every tree that is in full bearing, old and young trees being exempted as unproductive. And, at Marzouck, in northern Africa, a tax of one dollar is levied upon every 200 date-trees*.

* BUCHANAN'S Travels through Mysore, &c. vol. ii. p. 401. LYON'S Travels in Africa.

The cottages of the inhabitants are always surrounded by a great number of palm-trees, more particularly of the coco-nut palm; and those plants seem to thrive best which are situated near to the dwellings of the inhabitants. This circumstance has given rise to an observation of the natives, namely, that a coco-nut tree delights in conversation. The ashes which result from the burning of wood, for culinary purposes, is a more probable cause of the luxuriance of the trees close to the cottages, as the sweepings of the huts are generally deposited at the foot of a tree. The cluster of trees which surrounds a hut is called a "Toddy tope" by the English. *Tope* is perhaps a corruption of our word *copse*. *Watte*, a Singhalese word, is used to designate every description of plantation. *Pol-watte* signifies a coco-nut garden or plantation. I have already stated that the Singhalese almost always construct their huts under the dense shadow of palm-trees of different kinds. This comfortable mode of defending habitations from the direct influence of an ardent sun, seems to have in ancient times been practised in Judea (Judges, iv. 5.), and it is very generally adopted in all countries where the palm family is found to thrive.

SYNONYMES.

<i>Nari Kaylum Tangadra,</i>	-	Sanscrit.
<i>Polgaha,</i>	-	Singhalese.
<i>Palma Indica coccifera angulosa,</i>	-	Burman. Zeyl.
<i>Calappa Palma indica major,</i>	-	Rumph. amb.
<i>Tenga,</i>	-	Rheede.
<i>Taygana,</i>	-	Canarese.
<i>Tenkay, Narica, Kobari,</i>	-	Telinga.
<i>Cagolli,</i>	-	Mexican.
<i>Masogua Inaiguaruiba,</i>	-	Brasillian.
<i>Cây Dua,</i>	-	Cochin Chinese.
<i>Yâi Xú,</i>	-	Chinese.
<i>Cocos Palma,</i>	-	Loureiro.
<i>Cocotier or Cocos,</i>	-	Labat.
<i>Coco or Coco-nut tree,</i>	-	English.

When very young, the fruit is called *Bellaca* by the inhabitants of the Malabar Coast, who speak the Tamool language, and *Coquinhas* by the Portuguese; Singhalese, *Kooroomba*. When fully formed, but with a soft pulp, it is called *Elani* by the Tamools, in Portuguese *Lania*. When a little firmer, it is called *Tenga* in the Tamool language, and *Coquo* in the Portuguese. The mature nut is called *Cotta tenga* by the Malabars, and *Coquo sicco* by the Portuguese. In the Singhalese language, the nut is called *Pol*. The term *Coco*, by which this palm and its fruit is distinguished, is said by several authors to be of Portuguese origin. BAUHIN tells us, that *Coco*, or *Coquen*, is derived from the three holes at the end of the nut, giving it the resemblance of a *Cercopithecus*, a species of monkey. St PIERRE, in his *Harmonies of Nature*, says, that a *coco-nut*, stripped of its pericarp, bears an exact resemblance to the head of a negro. PISO asserts, that the term *Coco* has been applied to the tree, on account of the sound emitted, when air is blown into one of the holes of the nut, having a resemblance to the voice of an ape. The Portuguese name for a monkey is *macaco*, or *macoco*. There is, however, better foundation for supposing that *Coco* is derived from the Greek word *κκος*, a *seed*, or *berry*.

USES.

Roots.—This part of the tree is sometimes masticated by the natives in place of the *areca-nut*. The Brazilians make baskets of the small roots.

The hard woody shell or crust of the trunk is employed by the natives in making drums, and in the construction of their huts, &c. It is also much employed for making gutters. Towards the base of the trunk the wood is remarkably hard, and admits of a high polish. A transverse section of this part of the tree, when well polished and var-

nished, has a lapideous gloss and beauty, which rival those of an agate. I have seen a polished portion of the wood set in the lid of a silver snuff-box, in the same manner as jewellers occasionally fix agates or cornelians. It might, I think, be found highly useful in ornamental cabinet-work.

In some parts of the world, I am informed that a kind of cradle or couch for young infants is made of the reticulated substance formed at the base of the leaf. I never saw it applied to this purpose in Ceylon; it is there chiefly employed as an instrument of filtration, for straining the sweet juice which is extracted from the flowering spath of this tree. The Reverend J. CORDINER asserts, that it "is manufactured into a durable sackcloth, called *gunny*, which is used in making bags for transporting grain," &c.; and Captain PERCIVAL says, that it is manufactured into a coarse cloth called *grinjakken* (I presume he means *ganja sakken*) or gunny-cloth. If I mistake not, their statements are erroneous; gunny-cloth is made of hemp. Gunny or Goni is not improbably a corruption of ganja, the Hindostanee name of the hemp-plant (*Cannabis sativa*). According to BUCHANAN, goni-cloth is made from the *Janupa* (*Crotolaria juncea*)*. Sacks made of goni-cloth, are in India called *gunny-bags* by the English, and *ganja sakken* by the Dutch.

The unexpanded leaves or terminal leaf-bud is occasionally eaten by the Europeans as well as by natives. When boiled it is tender, and forms a good substitute for cabbage. The natives sometimes preserve it in vinegar, and eat it as a pickle. It may be observed, that the tree dies when this part is removed.

Many of the indigenous inhabitants, as well as natives of

* Journey through Mysore, &c, vol. i. p. 226,

Europe, thatch their houses with coco-nut leaves, in the Singhalese language called *polattu*. Sometimes they are denominated *ollahs*, and at other times *cadjans*. The latter term has, I believe, a Malay origin. To prepare *cadjans*, the central ligneous portion of the leaf is divided longitudinally, the leaflets of each half are then plaited or interwoven, by which means they are adapted for a variety of uses. In this state they are employed to thatch cottages, to shelter young plants from the scorching rays of the sun, to construct fences, to form the ceiling of rooms, and to make baskets for carrying fruit, fish, &c. Sometimes baskets are made of palm-leaves, so close as to serve the purpose of buckets to draw water from deep wells. In the Maldiv Islands, *bonnetta*, a species of fish, is preserved by a process in which coco-leaves are employed. The process consists in removing the back-bone, and laying the fish in the shade, occasionally sprinkling it with sea-water. After a certain period has elapsed, the fish is wrapped up in coco-nut leaves, and buried in sand, where it becomes hard. Fish thus prepared, is known in Ceylon, and perhaps over all India, by the name of *cummelmus*. The pieces of this fish brought to the market have a horny hardness. It is rasped upon rice, to render it savoury.

The unexpanded leaves are employed to shew marks of respect to persons in power. When the Governor or Chief-Justice travels, lines, made of the stems of creeping plants, are stretched along on each side of the road, about three or four feet from the ground. Upon these lines young palm-leaves are suspended. The head civil servant of a district may command the inhabitants under his immediate controul to adorn the road along which he passes, but he is not warranted in claiming this mark of attention beyond his own district.

The immature leaves of the coco-nut tree have a fine

yellow colour, and a beautiful texture resembling fine leather or satin. In some parts of Ceylon, the natives evince great taste in ornamenting triumphal arches, as also ball-rooms, and similar places of public resort, with the leaves of this tree, and some remarkably beautiful species of moss. As the young leaves are translucent, they serve to make lanterns, in the construction of which many of the inhabitants are very dexterous.

The practice of shewing respect to individuals by means of the branches of palm-trees appears to be very ancient. See Matthew xxi. 8, Mark xi. 8, and John xii. 13. The foliage of the palm tribe of plants has been in many countries considered an emblem of joy and victory, and hence the word palm is sometimes employed as a synonyme of victory and triumph. See Leviticus xxiii. 40. In ancient times, when pilgrims resorted to Palestine, they commonly returned bearing palm-leaves; on this account they were denominated Palmers. Captain LYON, when describing the amusements of the natives of some parts of northern Africa, informs us, that the dancers “ were directed by an old woman, with a torch in one hand, and a long palm-branch in the other, and sung in chorus verses which she repeated to them.” In the island of Otaheite, the female inhabitants wear bonnets constructed of the leaflets of the coco; and, in Ceylon, the European soldiers manufacture hats of small strips of the leaves, in the same manner that straw-hats are made. Indeed, broad-brimmed hats of this construction are frequently worn both by Europeans and natives, particularly by fishermen, who are much exposed to the direct rays of an ardent sun.

The leaflets are sometimes used to write upon, and the instrument employed to make the impression is an iron stylus. The leaves of the Palmyra (*Borassus flabelliformis*), or Talipot (*Corypha umbraculifera*), are, however, much

more frequently employed for this purpose. Contracts and other legal instruments are often engraven upon tablets of copper, which have occasionally a border of silver. An allusion is made to the practice of writing upon tablets in Isaiah xxx. 8, and Habakkuk ii. 2. Palm-leaves generally undergo some preparation to fit them to receive the impression of the stylus. They are then called *ollahs*. The natives write letters to one another upon *ollahs*, which are neatly rolled up, and sometimes sealed with a little gum-lac. During the operation of writing, the leaf is supported by the left hand, and the letters scratched upon the surface with the pointed piece of iron. Instead of moving the hand with which they write towards the right, they move the leaf in a contrary direction, by means of the thumb of the left hand. To render the characters more legible, the engraved lines are frequently filled by besmearing the leaf with fresh cow-dung. This substance is then tinged black, which makes the writing very plain. Sometimes this object is obtained by rubbing the lines over with coco-nut oil, or a mixture of oil and charcoal-powder. The natives do not require tables to write upon; they can write standing as well as walking.

Baskets for catching fish, shrimps, &c. are made of the ligneous ribs of the leaflet; the same substance is employed by the natives for many of the purposes for which we use pins. A bundle of these ribs is in universal use, as a broom, to sweep the cottages; and when an European asks for a tooth-pick, his servant brings him a portion of one of these fibres. Lately, I am informed, they have been recommended to be employed as a nucleus for bougies.

In a domestic state, elephants are fed chiefly upon coco-nut leaves, and this animal evinces much sagacity in separating the elastic woody fibre from the thinner margin of the leaf.

For temporary purposes, cadjan-houses are frequently constructed, both by natives and Europeans. During the insurrection in the Kandyan country in 1818, many of the sick were accommodated in cadjan-hospitals. Except the frame-work, every part of the house, walls, and roof, is formed of coco-nut leaves. They are capable of resisting all kinds of weather for a year or more.

To prevent thieving, the owners of topes frequently fix a coco-nut leaf along the stems of fruit-trees. As the leaf rustles much when touched, a thief is cautious of ascending the trunk of the tree, lest he should alarm some of the inmates of the neighbouring huts. THUNBERG mistook the use of these leaves, and supposed that they supplied "the place of ladders, by means of which the natives could climb up, and gather the fruit *."

In warm climates, it is customary to travel during night, with the view of avoiding the influence of an ardent sun. Torches then become necessary, and coco-nut leaves are chiefly employed for this purpose. By tying the leaflets close to the centre-rib of a leaf, the ignition is prevented from being too rapid. Torches of coco-nut leaves are commonly denominated *chæls* (*ooloo attu*, Singhalese); they are in constant use, to obstruct the inroads of wild beasts upon cultivated fields, more particularly of elephants. In the interior of Ceylon, every field under cultivation must be watched during night, to prevent the depredations which would be made upon the crops, were these animals to have free ingress. When burned, the coco-nut tree, especially the leaves, afford a large proportion of potash. The caste of washermen avail themselves of this quality, and procure all the potash they require by the incine-

* Travels, vol. iv. p. 192,

ration of different parts of the tree. Soap is very little used by the native washermen in Ceylon.

Boats are rowed with the centre-rib of the leaf, in which operation it forms a substitute for paddles. The end of this part of the leaf is sometimes well-bruised, and thereby converted into a brush, that may be used for a variety of purposes.

The spaths, or fibrous covering of the blossoms, are inflammable; on that account they are often employed as torches. In some parts of India this part of the tree is soaked in water, and converted into coarse cordage, with which the thatch of houses is tied.

Many useful products are derived from the flower and fruit of this tree. By a peculiar manipulation the flower yields a rich saccharine juice, convertible into arrack or sugar. The word *arrack*, or *arak*, or *rack*, is probably a corruption of the Arabic word *urug*, spirit or juice, indefinitely; whence we may infer that the art of distillation was conveyed from Arabia to India and the eastern archipelago. We are informed that, in the Ladrone Islands, it is called *uraca*. In Ceylon, and many other parts of India, the term arrack is employed in a sense similar to that with which we use the phrase spiritous liquors. Distilled spirits, of whatever kind, obtain this denomination through a great part of Asia, and along the northern coast of Africa. In the Singhalese language, sugar, manufactured from palm-juice, is called *hackurur*, which is commonly corrupted by foreigners into jagery, and may be the origin of the Arabic word *sukker*. A Sanscrit scholar has suggested, that *sugar* may be derived from the Sanscrit word *goor* (sweet); the superlative of which, he tells me, is *seogoor* (sweetest).

Sweet juice is extracted from the unexpanded flower, in the following manner:—A man, in colloquial language,

called a "Toddy-drawer," cuts off the point of the spadix, and ties the stump firmly round with a ligature. It is then beaten with a stick; which operation is supposed to determine the sap to the wounded part. This process is repeated for several days, cutting off daily a small portion of the end of the spadix. Under this management, the juice soon begins to flow from the cut surface of the flower, and is carefully collected in an earthen-ware vessel, suspended from the spathe. A thin portion of the flower and spathe is sliced off daily, and the end of the stump is bound with a ligature. A good healthy blossom will give from two to four English pints of sweet juice daily, and some flowers will continue to yield juice for about four or five weeks. Hence there are frequently two spaths on one tree, yielding toddy at the same time*.

I may here state the mode by which a toddy-drawer ascends the tree. He takes the dried stem of a creeping plant, and forms it into a circle of about a foot diameter. The feet are next put into this circular band. He then raises himself up a little on the stem of the tree, by means of his hands, and subsequently supports his whole weight upon the feet and the connecting ligature. By the alternate motion of his hands and feet, he reaches the top. The ordinary implements of a toddy-drawer, are, the shell of a large gourd, capable of containing several pints of sweet juice, and a broad knife, which he suspends to a belt tied round his waist. In Bombay, the stem is sometimes notched on each side, to enable the toddy-drawer to ascend the tree.

* "The Gomuti Palm yields toddy for two years, at the average rate of three quarts a-day."—CRAWFURD on the Indian Archipelago.

According to LABILLARDIERE, a date-palm will furnish, for upwards of two months in the year, six or eight *litres* of liquor a day.—"Account of a Voyage in search of PEROUSE, by M LABILLARDIERE, vol. i. p. 334.

But when it is intended to draw juice from a “tope” or cluster of trees, the toddy-drawer collects a quantity of some creeping plants, with which he connects the heads of a great number of trees. In some districts, coir-rope is used in place of these creepers. There are a number of species of creepers, suitable for this purpose, which have stems many yards long. The toddy-drawer selects a tree, of easy access, near to the centre of the tope, the trunk of which he surrounds with a number of bands made of some creepers, each at about a foot distance. He then ascends, by means of these bands, and passes along, from tree to tree, upon the connecting stems, assisted by the horizontal leaves, collecting, as he proceeds, the sweet juice, which he pours into the shell of the gourd, suspended from his waist, and conveys it to the ground by means of a line. The gourd is emptied by a person ready to receive it, and the line is drawn up by the man on the tree.

Juice is seldom drawn from a coco-nut tope, above six or seven months at a time, as this operation is supposed to exhaust the trees. During the intervening period, nuts are produced.

Toddy is the name given by the English to the sweet juices which are extracted from the different species of the palm tribe, including that of the coco-nut tree. It is perhaps a corruption of *tari* or *taree*, the Mussulman name of the juice of the Palmyra palm, of which *tar* or *tal* is the Sanscrit name*. *Ra*, which literally means juice, is the Singhalese name of the fluid extracted from the flower of a coco-nut tree. Sometimes it is called *Mee-ra* (honey or sweet juice); seldom, however, except when prepared for making *jagery*. Among the inhabitants of the maritime provinces of Ceylon, it is frequently denominated *suri*, which is said to be a Sanskrit word. With the above ex-

* BUCHANAN'S JOURNEY through Mysore, &c.

planation, the words *toddy*, *ra*, *mee-ra*, and *suri*, may be used synonymously. Fresh drawn juice is sweet, and has a peculiar flavour, in consequence of some extractive matter it contains; and, in general, it operates as a laxative. When it is intended to distil arrack from *suri*, the toddy-drawers seldom change or clean the pots into which it is received, hence the juice soon ferments, and emits an acid smell. In a half fermented state, *suri* is much relished by some Europeans. When it has become, by fermentation, highly intoxicating, the European soldiers, and the dissipated portion of the natives, drink it freely. To render this beverage acrid, the soldiers occasionally add green *chillies* (*Capsicum frutescens*) to it.

Is it not very probable, that the strong drink mentioned in Scripture was *mee-ra*, drawn from the flower of some of the palm tribe (palm-wine)? In several of the Oriental languages, there appears to be an intimate connection between the words which designate honey, sugar, sweetness, and the juice of the palm family of plants. *Mee*, in the Singhalese language, means honey, sweet; and the toddy, or juice extracted from palm trees, is called *mee-ra*. Juice drawn from the flower of the Sago-palm, is, by the Malays, denominated *Aer* (water) *saguer*. As the word *saguer* appears to be only a slight alteration from the Sanscrit adjective implying *sweet*, *aer saguer* will therefore literally mean *sweet water*, or the *sweetest water*. In the Javanese language, the juice of the Gomuti-palm is called *lagen*, which means the *sweet material* by distinction*. We learn from SHAW, that the Hebrew word rendered *honey* in Scripture, is, by some commentators, supposed to denominate the sweet juice procured from palm trees, as well as the honey of bees. He tells us that, in Barbary, the sweet juice extracted from date-palms, is called *dipse*; and that

* CRAWFURD.

dibse or *dipse*, which is a Hebrew word, is generally translated *honey* in the Old Testament *. Dr MOSELY, in his Treatise upon Sugar, &c. says, that the strong drink of the Scripture was called *shecar*, a word which likewise means *intoxication*. This word *shecar*, does not differ much in enunciation from the Sanscrit adjective implying *sweet*; and it very closely resembles the Malay name of the intoxicating toddy of the Sago-palm (*Aer saguer*). Dr MOSELEY concludes his disquisition on the strong drink of the Old Testament, by saying, “ What sottish liquor *shecar* was, no person knows. It was probably made from grain, perhaps from honey †.”

The suri pots are sometimes visited, and the contents carried off during night. To detect the thief, the leaves of a species of *datura* are occasionally put into some of the pots. By means of the highly intoxicating effect of this compound, the marauder is often discovered.

Arrack may be distilled from suri the same day it is drawn; but sometimes this operation is delayed for a few days, without diminishing the quantity, or injuring the quality of the spirit. The process of distillation is carried on, in the maritime provinces, in copper stills; but, in the Kandyan Provinces, earthen-ware vessels are chiefly employed. Suri yields, by distillation, about one-eighth part of arrack, of the same strength as good brandy. Arrack, when well prepared, is clear and transparent: generally, however, it is slightly straw-coloured. It has a peculiar flavour, no doubt depending upon an essential oil which rises from the suri during distillation. Arrack is issued to the soldiers in India and Ceylon, as part of the established

* SHAW'S Observations relating to Barbary and the Levant, vol. ii. p. 144, note.

† Medical Tracts, by Dr MOSELEY, 2d edit. p. 138.

ration. The seamen belonging to the Royal Navy in the Indian Seas are furnished with this spirit in place of rum.

Ceylon exports annually, and, for the most part, to the Presidencies of Bengal, Madras, and Bombay, from 5000 to 6000 leaguers of arrack, each containing 150 gallons. Including freight, duties upon exportation and importation, this spirit is sold at Madras at about 1s. 3d. per gallon. The prime cost of arrack in Ceylon varies from 8d. to 10d. per gallon. It is stated by Mr BARTOLACCI, that arrack distilled at Batavia, is said to be sold in India from 10 to 15 per cent. cheaper than that brought from Colombo.* Ten per cent. duty is levied upon arrack exported from Ceylon. In England, this spirit has brought as high a price as from 5 to 6 shillings per gallon.

Batavian arrack is made from a mixture of molasses, palm-wine, and rice, in the following proportions :

Molasses,	-	-	-	62 parts.
Toddy (palm-wine),	-	-	-	3 ditto.
Rice,	-	-	-	35 ditto.

100 parts of these materials yield $23\frac{1}{2}$ of distilled proof arrack.

The rice is first boiled ; and, after cooling, a quantity of yeast is added to it, and is pressed into baskets. In this condition, it is placed over a tub or tubs, for eight days, during which time, a liquor flows abundantly from the mixture. At the end of that time, the liquor which has subsided, is taken out and mixed with the molasses and palm-wine, which has been previously combined. The mixture remains in a small vessel for one day only, when it is removed into large fermenting vats, in which it remains for seven. The liquor is finally removed into the still ; and, according to the number of distillations it un-

* BARTOLACCI on the Revenue and Commerce of Ceylon.

dergoes, becomes arrack of the first, second, or third quality in commerce. The above account of the preparation of arrack, is extracted from Mr CRAWFURD's work on the Indian Archipelago. Mr MARSDEN* informs us, that the "Palm-wine" used in this kind of arrack, is obtained from the coco-nut tree; and that arrack of the first quality may be purchased for about 60 Spanish dollars; second for 50; and the third for 30; each leaguer of 160 gallons. At this rate, the best arrack may be procured for 20d. per gallon. It is at present manufactured chiefly for domestic consumption.

The phrase "Pariah-arrack" is often used to designate a spirit distilled in the Peninsula of India. Arrack, there prepared, is said to be often rendered unwholesome, by an admixture of *ganja* (*Cannabis sativa*), and a species of *datura*, with the intention of increasing its intoxicating quality. It is not clear, whether the term Pariah-arrack be colloquially employed to designate an inferior spirit, or an adulterated compound.

There is a spirit prepared in the neighbourhood of Madras, called *puttay* or *putta arrack*, literally bark arrack. *Puttay*, in the Tamool language, signifies the bark of a tree. Dr AINSLIE tells us, that the barks chiefly used in making arrack, are those of the *Mimosa ferruginea*, and the *Mimosa leucophlea* of Roxburgh †.

Suri is the yest commonly used by bakers in Ceylon. By allowing it to pass into the acetous fermentation, an excellent vinegar is obtained. A great variety of vegetable substances are pickled with vinegar of this kind.

When it is intended to extract jagery from suri, great care is taken to prevent it from fermenting. The earthen-

* History of Sumatra.

† Materia Medica of Hindoostan.

ware pot into which it falls is emptied twice or thrice in twenty-four hours. After this operation, the pot is always well cleaned, then dried, and a small quantity of *chunam* (lime) is thrown into it, before being replaced. Sometimes a portion of the bark of a tree, whose name I do not recollect, is introduced into the receiving vessel, instead of *chunam*. The lime perhaps contributes to check the progress of fermentation. Almost immediately after the *mee-ra* is drawn from the tree, it is filtered through a portion of the reticulated substance found at the base of the leaf.

The juice is then slowly boiled in an earthen-ware vessel, until it becomes light coloured, and acquires a considerable degree of consistency. While still warm, and semi-fluid, it is poured into sections of coco-nut shells, where it soon becomes solid. Twenty-four ounces of jagery may be procured from a gallon of *mee-ra*. I state the quantity of jagery which *mee-ra* yields, on the authority of Mr BERTOLACCI, who paid much attention to this subject. It would appear that *mee-ra* is richer in saccharine matter than juice expressed from the sugar-cane in the West Indies. Dr MOSELY, in his History of Sugar, says, "We consider a pound of sugar from a gallon of cane-juice as good yielding." According to Mr CRAWFURD, cane-juice in Java, yields, on an average, 25 per cent. of sugar. Jagery contains both the crystallizable portion of the juice; and a quantity of molasses, or liquid sugar; but, by a subsequent operation, they can be, in a great measure, separated. This coarse sugar is generally made into little loaves, having the shape of a hemispherical vase, from the form of the vessel in which it cools. It has a deep chocolate colour; and, when broken, presents many clear shining particles of sugar. In the Malay language, jagery is denominated *goola* or *goora itan* (black sugar or black sweet.)

The ordinary price of jagery is about 2d. per pound. It is the only sugar used by the native inhabitants, and no other is prepared in Ceylon. They enjoy the juice of the cane, by masticating the green shoots, but in no other way, although they have a name for sugar extracted in other countries from this plant, which is *sinee* or *chinee*. The common soldiers ordinarily use jagery; and many Europeans of the upper ranks prefer it to a more refined species of sugar for sweetening coffee. Sugar-candy, which is chiefly imported from China, is the saccharine substance commonly used by the higher classes of Europeans in India. In some parts of the interior of Ceylon, particularly in the vicinity of Adam's Peak, great numbers of the inhabitants support themselves by extracting a sweet juice from the nepery tree (*Caryota urens*), and manufacturing it into jagery. This tree grows spontaneously in the woods. The people thus employed, subsist chiefly upon coarse sugar. They occasionally procure a little rice and salt by barter, but they do not raise grain by cultivating the soil.

There is some foundation for supposing, that the sugar of the ancients, which seems to have been imported from India, was the produce of the palm family of plants, and not that of the sugar-cane. SALMASIUS, the commentator of PLINY, is decidedly of opinion, that the sugar of the moderns is the produce of a different plant from that which produced the sugar of the Greeks and Romans. All the authors on this subject, with whose writings I am acquainted, describe the sugar of the ancients as being of a very coarse quality, and mixed with a large portion of molasses, exactly resembling *jagery*, the produce of some of the palms. VIREY, in his Account of Sugar, says expressly, that "le premier sucre apporté des Indes n'étoit qu'une *moscouade* (*sucré brut*).” And, in an Essay upon the History of the Commerce of Venice, it is stated, that the sugar which was manufactured in Sicily, as early as

1173, brought a higher price than that which they imported from Egypt or from India, by the way of the Red Sea. The extraction of sugar from the sugar-cane is much more operose than from the juice afforded by palms; and this may be one reason why palm-sugar should be more early known than cane-sugar, even in countries where the sugar-cane is indigenous.

Among the articles of commerce which the Venetians imported from Asia, about the year 996, sugar is mentioned; but whether it was the produce of palm trees, or the sugar-cane, cannot be satisfactorily ascertained*. It is the opinion of Mr MARSDEN, that the sugar of the ancients was procured from palms. In his History of Sumatra he says, "If the ancients were acquainted with sugar, it was produced from some species of the palms, as the sugar-caness were not brought into the Mediterranean from the coast, till a short time before the discovery of the passage to India by the Cape. The word *saccharum* is conjectured to be derived from *jaggree*, which the French pronounce *schagaree*." His opinion is corroborated by Dr CRAWFURD, who informs us that, "although the cane be a native of the Indian Islands, the art of manufacturing sugar from it is certainly a foreign art. There is no name for sugar in any dialect of the Indian Islands, but a foreign one *gula* (*perhaps a corruption of goor sweet*); and this foreign one is pure Sanskrit. When Europeans first became acquainted with the natives of these islands, they found them ignorant of the manufacture of sugar from the cane. The Hindoo word *gula* (*sometimes written gour*) is indeed equally applicable to palm sugar as to that of the cane. I therefore suppose that the Hindoos instructed the Indian islanders only in the simple process of manufacturing the former, and that the manufacture of the latter was in-

* Essai de l'Historie du Commerce de Venise, p. 71.

roduced by the Chinese, under the auspices chiefly of Europeans, and in times comparatively very recent." I am aware, however, that HUMBOLDT infers, from some Chinese paintings which he saw at Lima, representing the different processes for extracting sugar, that this art is extremely ancient in that country.—(*Essai Politique sur la Nouvelle Espagne*, tom. ii. p. 425, 4to.)

It is stated, upon the authority of the Crusaders, that the inhabitants of Tripoli, in Syria, were acquainted with the art of extracting sugar from the sugar-cane, as early as 1108. The process they practised was extremely rude, and consisted in pounding the cane in a mortar with a pestle. At this time, they do not appear to have been acquainted with the means of employing fire in the making of sugar. The expressed juice was set aside until crystals formed in it*. For a long time, sugar appears to have, in Europe, been confined to the apothecary's shop; and, by some of the older authors, it is recommended as a good substitute for honey, to render nauseating medicines palatable; this seems to have been the chief purpose for which it was, during a considerable period, employed. Sugar did not become general, as an article of food in Europe, until it was extensively cultivated in the West Indies and America †.

* FALCONER'S Sketch of the History of Sugar.

† Neither sugar nor the sugar-cane is mentioned in Scripture. The word *Sweet-cane*, which we find in two places of the Old Testament, Isaiah xliii. 24., and Jeremiah vi. 20., seems to express a different substance, most probably cinnamon. In both passages, sweet-cane is mentioned as an article of merchandize, and not as a native of Judea, which the sugar-cane seems to be. It likewise may be inferred, that the substance here meant was consecrated to religious uses. Now, we know that, under the Levitical law, cinnamon was required to compose the holy oil for anointing the tabernacle. Europe is indebted to the conquests of ALEXANDER, for a knowledge of sugar.

When intimately mixed with lime, jagery forms an excellent cement, which resists moisture, and endures great solar heat. It is capable of taking on a very fine polish. Walls are prepared for receiving this covering, by wetting them with a strong infusion of the husk of unripe cocos; and the same kind of fluid is used for mixing and tempering the materials. In Madras, and some other parts of India, the flat tops of the houses are covered with this cement. It is much employed to cover columns, as also to form the floors of rooms. Floors of this kind are sometimes stained and made to resemble the finest marble. It is said that jagery-cement has succeeded very well in Holland. In 1813, Ceylon exported jagery to the value of 39,245 rix dollars. The Ceylon rix dollar at par, is equal to 1s. 9d. Sterling.

When the flower has not been injured, the tree bears nuts which are converted to many useful purposes. Young coco-nuts are much used by the natives as an article of diet. During the unripe state of the fruit, the shell is lined

SPRENGEL, in his *Historia rei Herbariæ*, informs us, that the sugar-cane is a native of the banks of the Euphrates; and that the first account we have of the fabrication of sugar from this plant, is not earlier than the fifth century. From Arabia, this reed found its way to Egypt, and eventually to Europe. In 1306, it was common in the Island of Cyprus; and, a hundred years after, it enriched Calabria, and the coasts of Spain. While Spain was under the dominion of the Moors, the sugar-cane was cultivated in Andalusia, and sugar manufactured from it. From Sicily it passed to Madeira, and the Canary Islands. Early in the sixteenth century it was transported to America, by a native of Portugal. OVIEDO saw some sugar manufactories in operation at St Domingo, in the year 1513; and, in 1520, it was carried to the Continent of America. In 1535, GONZALES DE VELOSA constructed the first cylinder for expressing the sugar cane; and, in 1641, canes were transplanted from Brazil to Barbadoes, and thence to the other West India Islands.—HUMBOLDT's *Personal Narrative*, vol. iv. p. 179; *Journal de Pharmacie*, tom. ii. p. 386; Rees' *Encyclopædia*, Article *Sugar*.

with a pulpy substance, while the centre is filled with an aqueous fluid. This fluid is at first slightly astringent and sub-acid; as the fruit ripens, it becomes sweetish, and not unlike the colour and consistence of the whey of milk *. When drank before the sun has far advanced, it is much cooler than the atmosphere, and is then a pleasant beverage. Natives, particularly when travelling, generally furnish themselves with a few unripe nuts (*Lanias* Portuguese), the water of which they drink, and eat the pulpy portion or kernel. Upon a few repasts of this kind, a man will labour from morning till night, without any other article of diet †. The native inhabitants of the coasts of some of the islands in the Equinoctial Zone, are more palmivorous than granivorous. Where a people can be satisfied with food so easily procured as the produce of the coco-nut tree is, in some tropical regions, they are little sensible to the ordinary motives which impel mankind to labour. The Reverend Mr CORDINER says, and perhaps with truth, that the person who possesses a garden with twelve coco trees and two jack trees, has no call to make any exertion.

The husk or fibrous pericarp of the nut is employed to polish furniture, and to scour the floors of rooms, &c. Birds, who build pendulous nests, commonly construct them of this substance. Its chief use, however, is in the

* The following are the proportions of the liquid contained in the nut, as given in the *Journal de Pharmacie*, tom. ii. p. 98., extracted from TROMSDORFF'S *Journal*:—"Le liquide est clair et sans couleur comme de l'eau, sans odeur, et d'une saveur douceâtre semblable aux noix. La pesanteur spécifique comparée à celle de l'eau est de 1,010."

The result of a chemical examination of the liquid is, that "le suc de la noix serait composé de beaucoup d'eau, du sucre liquide, d'un peu de gomme, et d'un sel vegetal."

† To fetch coco-nuts from trees as they are wanted, the Malays have trained monkeys, which are more expert at the business than any *toddy-drawer* on the coast of Coromandel.—HEYNE'S *Letters on Sumatra*.

manufacture of *coir*, and for this purpose the nut ought not to be completely ripe. The word *coir*, sometimes written *cair*, and *caira*, is probably derived from the Portuguese substantive *cairel*, a periwig, or fringe. The Singhalese word for *coir* is *kohu*. To remove the husk, an iron-spike, or sharp piece of hard wood, is fixed in the ground; the nut is then forced upon the point, which passes through the fibres, thereby separating the rind from the shell. In this manner a man can clear 1000 nuts daily. *Coir* is prepared by soaking the rind in water for several months, and then beating it upon a stone with a piece of heavy wood. On the coast of America, where a running stream of water is not near at hand, the coir-manufacturers dig holes in the sand below high water-mark, and bury the rind of the coco-nut, before beating it. Subsequently it is rubbed with the hand until the interstitial substance be completely separated from the fibrous portion of the husk. The rind of forty cocos furnished Mr KOSTER with six pounds weight of coir. The next operation is to twist the fibres into yarns, which are manufactured into cordage of all sizes. Coir is remarkably buoyant, and well suited for ropes of a large diameter. Until chain-cables were introduced, all the ships which navigated the Indian seas had cables made of this substance. Sea-water is said to be rather beneficial than hurtful to it. Coir-cordage, when properly prepared, is pliable, smooth, strong, and elastic: it is very well suited for running-rigging, more especially where lightness is deemed an advantage, such as top-gallant studding-sail sheets, &c. On account of its contractility, seamen consider it not well fitted for standing rigging. Dr ROXBURGH, in his observations on the comparative strength of English hemp and other vegetable fibres, states, that he found hemp-rope and coir-rope, when large, to be respectively as 108 to 87 in strength, and when

smaller, as 65 is to 60. In the same paper (Transactions of the Society of Arts, vol. ii.), he says, “Coir is certainly the very best material yet known for cables, on account of its great elasticity and strength.”

The natives sew the planks together which compose their boats with coir-yarns. When twisted into yarns adapted for being manufactured into cordage, it is valued in Ceylon at about L. 2 per candy (500 lb.) Large quantities of this substance are exported to the different ports in India. Under the Dutch Government about 3,000,000 lb. were annually manufactured in the island. The quantity of coir exported from Ceylon in 1813, amounted to 4,048½ candies, and each candy may be valued at 28 rix dollars, total amount rix dollars 137,649. Very lately a manufactory for the making of coir-cordage has been established upon a large scale at Recif, near to Pernambuco, on the coast of Brazil.

Coir is much used in India in place of hair to stuff mattresses, cushions for couches, saddles, &c. It is also employed to make brooms and brushes to white-wash houses.

The kernel of the ripe coco-nut is not unlike the substance of an almond either in taste or consistence*. It is

* The following chemical analysis of the kernel of the coco-nut I have extracted from the *Journal de Pharmacie*, tom. ii. p. 100:—

“La partie charnue a le consistence de nos noix fraîches; mais elle est plus tenace, d’un blanc éclatant, et d’une saveur douceâtre.”

“Il résulte que le noyau, ou la partie charnue de la noix, est composé de beaucoup d’huile grasse, se figeant aisément, ce qui peut engager à lui donner le nom de *beurre végétal*, d’un liquide aqueux, d’albumine, et de sucre liquide (mucoso-sucré).”

“En jetant un coup d’œil sur cette analyse, nous voyons que la noix du cocotier est une substance très nourrissante; car l’albumine est connue comme nourrissante quand même elle ne servirait ici qu’à animaliser les autres matières végétales. Le sucre et l’huile sont également connus comme

eaten by the natives, and frequently along with jagery. The natives of the Ladrone Islands eat it in lieu of bread, with meat and fish. Sometimes it is rasped into very small pieces, and mixed with dressed rice, to give it a peculiar flavour; and occasionally it is pounded into meal, of which fritters and small cakes are made. In India this fruit is generally allowed to be very nutritious, and many suppose that it possesses the quality of inducing corpulence.

By a little pressure the kernel may be made to yield a white fluid resembling milk. When the milk of cows or buffaloes cannot be procured, Europeans sometimes add this liquid to tea as a substitute. Another substitute for milk may be obtained by rasping a kernel, and mixing the scrapings with some of the liquid contained in a nut: this mixture requires to be strained. We are informed by Dr PINCKARD, in his Notes on the West Indies, that puddings are made of coco-nuts in Barbadoes. The kernel is sometimes pressed with honey and sugar, and used to make preserves.

When mature, the nut is much used in Ceylon, to furnish an oleaginous fluid required to prepare *curry*, a dish in very general use among all ranks and classes in India. For this purpose, the kernel is finely rasped by means of an iron instrument called a *homeny*, which resembles the rowel of a spur, and the raspings are washed with a small quantity of water, which is subsequently filtered. The emulsion thus formed is boiled along with the meat, fish, or vegetable substance intended to be "curried," and

des principes, nourrissans. Le noyau a beaucoup d'analogie avec le lait animal. Ce qui constitue dans le lait la matiere caseuse, est remplacé ici par le mucoso-sucre, et l'huile epaisse peut presenter le beurre du lait animal. On peut separer ici l'huile de la meme maniere qu'on sépare le beurre du lait."

thereby supplies the oily fluid necessary in the composition of curry. A due proportion of spices is added to the mixture before it is removed from the fire. When coco-nuts cannot be procured, *ghee* (clarified butter) is used as a substitute in the preparation of this delicious dish. In Bengal, and, I believe, over great part of the peninsula of India, curry is chiefly prepared with butter or *ghee*. The Ceylon or coco-nut curry possesses much of the flavour of the nut; it has a light-yellow colour, and is easily digested, the oily part of the mixture being seldom too abundant.

But the chief product of the kernel of the coco-nut is an excellent oil: and, to extract it, two different processes are employed; namely, decoction and expression. When the former process is followed, the fresh kernel is finely rasped; the raspings are next washed with water, which assumes a milky appearance; and, by decoction, yields a limpid oil. If the emulsion be exposed for a night, it separates spontaneously into an oily and a watery portion, and the oily part is purified by a very short boiling. To separate the oil, the operator, who is generally a female, lays the palm of her left hand flat upon the surface of the fluid; a portion of oil adheres to the hand, which is brushed off into a vessel by the right hand. The oil made in this manner is nearly as colourless as water, and when newly prepared does not smell offensively. In the course of a few days, particularly if exposed to the atmosphere, it emits a disagreeable odour. On an average ten nuts are stated by Mr BARTOLACCI to yield about a quart of oil; but KOSTER, who made the experiment, says, that thirty-two nuts rendered him only 3 lb. of pure oil.

Compression is the process chiefly adopted when coco-nut oil is prepared in the large way. After clearing the nut of the husk, the kernel is exposed, which is effected by breaking the shell with a crooked knife, an operation which

is generally performed by one stroke. The watery part of the kernel is dissipated by exposing it to the sun for a few days, during which period it acquires a considerable degree of rancidity. In this state the kernel is called *copra*, or *copperas*. The oil is extracted from *copra* by grinding it in a very clumsy mill, which is worked by bullocks. Oil has for some years past been extracted from *copra* in large quantities at Colombo, by means of the power of a steam-engine. The value of *copperas* exported from Ceylon, in 1813, amounted to 27,975 rix dollars.

The substance which remains after the oil has been extracted from *copra* is called *taur*, which serves well to feed pigs, poultry, &c.

Ceylon exports annually a great quantity of coco-nuts, chiefly to India. In 1809, the number amounted to 2,977,275. The medium price may be stated at about 3s. 6d. per hundred, or nearly one halfpenny a-piece. According to KOSTER, the value of coco-nuts in Brazil is about 5s. 6d. per hundred, or a little more than $\frac{6}{10}$ ths of a penny each. In Ceylon they pay an export duty of 5 per cent. These nuts are sometimes brought to this country from the West Indies. The captains of ships use them instead of wedges of timber, to fill up the vacua between the casks and other packages which compose their cargoes. On this account, the freightage of the nuts adds little to their original value. They are therefore now said to be as common in the shops and streets of London as the orange. I know they may be procured in great abundance at Liverpool.

Coco-nut oil may be exported from Colomba, at about 1s. 6d. per gallon; and, at this price, a large quantity is annually sent to different parts of India. In Java, where it is an article of importation, the market price is usually about six Spanish dollars a-picul, which is equal to about

1s. 9d. per gallon. Within these few years it has been imported into Great Britain, where the same quantity has been sold as high as from 5s. to 6s. The quantity exported from Ceylon, in 1813, amounted to 27,265 measures, each measure about two pints; value in rix dollars 7952.

In Ceylon this oil is universally used both by Europeans and the indigenous inhabitants, as a lamp-oil. The natives burn it in a section of the coco-nut shell, or in a small earthen-ware vessel. Some of the upper ranks have brass lamps four or five feet high, which have several flat basins, with projecting beaks, affixed to a vertical stalk. The oil is introduced into the basins, the beaks of which are furnished with cotton-wicks. Torches are prepared in Siam, by drying elephants' dung, soaking it in coco-nut oil, and then covering the mass with long dry leaves tied at short distances, with shreds of bamboo.

The Singalese, and indeed a great proportion of the inhabitants of Asia, use considerable quantities of this oil, for the purpose of external inunction. It is not easy to ascertain precisely the benefits they expect to result from this practice. Some of the Orientals say, that inunction is used for the purpose of preserving their skins from the sun and wind. They sometimes anoint their bodies previously to going into the bath, probably for the purpose of diminishing the shock they might feel by a sudden reduction of the temperature of the skin: more commonly, however, the inunction takes place upon emerging from the water. The oil is applied with a considerable degree of friction; or, as DAMPIER describes the process, "Chafing it for half an hour into hair and skin;" and the whole surface of the body, from the crown of the head to the soles of the feet, is generally anointed. It is perhaps more frequently applied to the hair of the head than to any other part of the body. I cannot, however, learn that they intend to destroy

vermin by this means, although, in all probability, it may have such an effect. The Asiatics, without much exception as to rank, do not seem to consider this source of disquietude as either uncomfortable or disgraceful. Captain LYON, who seems to have practised the inunction of oil, while in Northern Africa, says, “It is very refreshing, after a long day’s journey, to be well oiled over.”

Coco-nut oil is a good substitute for olive oil, in the composition of pharmaceutical preparations, such as ointments; plasters, &c. In the laboratory at Colombo, it is employed in a number of the preparations where olive-oil is directed to be used by the different pharmacopœias. One of the editors of the *Journal de Pharmacie*, says, respecting coco-nut oil, “*J’ai aussi observé que cette huile divisait mieux le mercure qu’aucune autre huile végétale.*”— (Tom. ii. p. 101.)

Mixed with *dammer* (a species of resin) and the compound melted, a substance is formed which is much used in India to pay the seams of boats and ships, in place of pitch. The same compound is employed to protect the corks of wine and beer bottles from the depredations of white ants.

In this country, it has been employed as a lamp-oil, and in the manufacture of cloth, instead of olive-oil. Soap and excellent candles are made of it; and I am informed the glass-blowers prefer this oil to all others in their operations.

Hitherto the importation of coco-nut oil into Europe has been attended with much waste by leakage, in consequence of having been imported in casks, the wood of which permits the contents to pass through in large quantities. Between the tropics, the temperature of the cabin or cuddy of a ship, is frequently as high as from 83° to 86° Fahren.; that of the hold must be considerably higher. Coco-nut oil does not freeze until the temperature be reduced to 73°

Fahren. Hence it is in a fluid condition during the greater part of the voyage from India.

The shells of coco-nuts are manufactured into beads for rosaries. They are also used as drinking-vessels, and for various other domestic purposes. Occasionally they are polished by the natives, who cut figures in relief upon them. When thus ornamented, they are sometimes employed by the English as sugar-basins. In the neighbourhood of Monte Video, in South America, the ladies drink an infusion of an herb called *matte* (Paraguay tea) from highly ornamented coco-nut cups. They extract the tea from the cup by sucking it through a long silver tube. The common ladle used in great part of India and in the Brazils, is formed of a part of a nut, to which a long wooden handle is fixed. In America they have even given a name to the instrument, for ladles made of silver are called *silver cocos*. By the inhabitants of some of the Oriental Islands, they are employed as a measure for ascertaining the quantity of both dry and fluid substances. Their capacity is known by the number of *cowries* (*Cyprea moneta*) they will contain. Hence there are cocos of 500 or 1000 cowries, and so on.

They are used as fuel by the goldsmiths; and, when converted into charcoal, they are mixed with lime, and employed to colour the walls of houses.

As an article of the *Materia medica*, the natives of India recommend a decoction of the roots of the coco tree, mixed with ginger, as an excellent febrifuge. The juice expressed from young branches, combined with oil, is said to be a useful application to hæmorrhoids. In chronic inflammation of the bladder, and gonorrhœa, they recommend a mixture of the expressed juice of the flower of the coco-tree and sugar. The oil is said to be useful, if applied to ulcers or pustules on the head. Mixed with salt, and drank to the quantity

of eight ounces, it is said to expel worms from the intestines. Particular virtues have been attributed to cups made of the shell of the nut. They have been supposed to give an antiapoplectic quality to intoxicating liquors. Many other virtues are ascribed to different parts of the tree, of which it is not necessary here to take notice.

When coco-nuts are intended for seed, they are placed close to one another, with the holes uppermost, and covered with a small quantity of earth. In a short time, the aqueous fluid is absorbed, and the cavity becomes filled with a spongy-white substance. •Through the largest of the three holes the plumula passes, and sometimes along with it the radicles, which run downwards on the outside of the shell. The seedlings are allowed to remain in this state for about a year before they are transplanted. Holes of about 2 feet deep and from 25 to 30 feet distant from each other, are dug in the field intended for a coco-nut garden, and the young shoots put into them. A little earth is put round the nut; and, in dry weather, the plants are watered. They require to be protected from cattle, and particularly from elephants.

VIII. — *Observations on the Organs of Digestion and their Appendages, and on the Organs of Respiration and Circulation, in the Ornithorynchus paradoxus**.

By ROBERT KNOX, M. D.

Member of the Wernerian Natural History Society, and of the
Medico-Chirurgical Society of Edinburgh.

(Read 26th April 1823.)

MEMOIR II.

SO extremely accurate, generally speaking, are the descriptions of the celebrated CUVIER, so just and profound the views he has adopted of the animal creation, that those pursuing the same route can hope to add but little to any

* The specimen of Ornithorynchus, examined by Dr KNOX, was transmitted to the Royal Museum of the University of Edinburgh by His Excellency the Governor of New South Wales, Sir THOMAS BRISBANE, Baronet. It is highly gratifying to learn, that this distinguished individual is actively employed in forming an extensive collection of the natural productions of the vast country over which he rules; and that the numerous, uncommon, marine animals of the neighbouring coasts and seas, which have so much excited the curiosity of European naturalists, also engage his particular attention, so that, ere long, we trust, many of these will reach our National Museum of Scotland, and thus afford opportunities for interesting investigations and discoveries.—EDIT.

individual portion of anatomical science to which the undivided attention of that distinguished author has been directed. This observation will explain the brevity of this and the succeeding Memoirs on the anatomy of the Ornithorynchus, for most of the internal organs, which now fall to be described, have been already submitted by him to a minute dissection.

It has been already remarked, that, properly speaking, there is no ascending branch of the lower jaw in the Ornithorynchus, instead of which there is found only a slight curvature; the coronoid process is small, though sufficiently distant from the condyle; and the general disposition of the glenoid cavity, for receiving the condyle, seemed to me such as to admit of extensive motion from before, backwards, and also horizontally. This agrees with the configuration of the mouth and palate, and with the total absence of all cutting or incisive teeth. Whatever be the food swallowed, whether insects or aquatic vegetable matter, it must be submitted to a certain degree of trituration in the mouth, and, to effect this completely, is conveyed into two large bags or cheek-pouches placed on each side of the head, and the only entrance into which is between the large grinding-teeth. This was essential to the existence of the animal, and results from the structure of its stomach, which, being totally without that strong cuticle and powerful muscles by which the food is trituated in birds and some other animals (as in the *Myrmecophaga capensis*), required that the whole of the functions of mastication, the complete trituration of the food, and its reduction to a pulpy mass fit for the immediate action of the gastric juices, should be performed in the mouth. The cheek-pouches, situated a little behind the angles of the mouth, are capable of containing a considerable quantity of food; they are lined by a strong cuticle, and have posteriorly a gland, which evidently pours

its secretions into the corresponding pouch, and must be considered as the parotid. They are formed chiefly by the buccinator muscle, and are supplied by branches of the facial nerve.

The teeth of the *Ornithorynchus* have generally been described as four in number, that is, four large grinding-teeth, placed two in either jaw, at the entrance of the cheek-pouches: but some anatomists seem to have overlooked four narrow, horny bodies, placed over the maxillary bones, in the same line with the grinding-teeth, but anteriorly to them. They are about $\frac{7}{10}$ ths of an inch in length, and $\frac{1}{10}$ th where broadest. They are composed of a horny substance, and are evidently of the same nature with the true grinding teeth: they are to be considered as corresponding to the smaller grinders of the *Mammalia* *. The structure of the larger grinding teeth has been considered by M. CUVIER as the most extraordinary amongst quadrupeds. They are said to be composed of a great number of small, straight, and parallel tubes, so that the surface of a transverse section resembles absolutely that of a bamboo-cane (*jonc à canne*): these tubes are not closed, and the tissue of the tooth is compact only at the triturating surface: there is no large cavity in the interior of the tooth. These peculiarities in structure, described from the teeth of the *Orycteropus*, may readily be distinguished in the larger grinding teeth of the *Ornithorynchus*. These on their grinding surface were very much hollowed out, instead of being tubercular; they may be fairly considered as connected with the integuments only, since their structure is so different from the teeth of all other animals, and

* I have made no mention here of the two teeth which are implanted into the tongue, and which were described with that organ in a former memoir

the alveolar cavity, into which they are received, is lined throughout by the true dermis; they are simply analogous therefore to cuticle, horn, &c., and have nothing osseous in their composition.

The salivary glands need not detain us long. The parotid has been already described. The only other salivary gland which I remarked, was the maxillary, situated on either side, over the great nerves and bloodvessels, high in the neck, and close to the lower jaw. From this there proceeded a long canal passing over and through the muscles going to the tongue, and running parallel to that organ; near its termination it becomes very zigzag, and diminishes in caliber; it pierces the membrane of the mouth at the sides of the anterior portion of the tongue, and near the union of the branches of the lower jaw-bone. These maxillary glands are large, but not remarkably disproportioned to the size of the animal, as is said to be the case in the *Echidna*, in which animal the parotids are wanting.

It could scarcely be interesting to the Society to detail the observations made on the muscles of the tongue, palate, and of those connected with the *os hyoides*, as it would be but a repetition of what has been already so well described by M. CUVIER. The larynx itself is composed of the usual cartilages and muscles, sufficiently distinct; the epiglottis and arytenoids are well marked, and I thought the thyro-arytenoids rather strong: the glottis is formed partly by the arytenoidei cartilages, and partly by the true vocal ligament; between which and the superior margin of the cricoid cartilage there is a considerable cavity or ventricle. Immediately above the vocal ligament and thyro-arytenoidei muscles, a small ligamentous and partly muscular cord, stretched from the base of the epiglottis to the anterior part of the arytenoid cartilages, running parallel with the true vocal cords, and immediately outside this, is a much lar-

ger muscular fasciculus, arising from the anterior part of the base of the epiglottis (or, anterior and superior, supposing the epiglottis to be laid down upon the glottis), and running parallel with the preceding, to be fixed into the base of the arytenoid cartilages. These cords correspond with the superior or anterior vocal ligaments of the Mammalia, and there even appeared to be a small cavity or ventricle situated between them and the true vocal cord.

The anatomy of the stomach, intestines, and liver, was found to coincide with the details in the *Anatomie Comparée* *. The following table will give an idea of the proportional length of the intestinal canal in the Ornithorynchus, Echidna, and Fourmilier.

Name.	Length of the animal.	Length of Small Intestines.	Length of the Cœcum.	Length of Colon and Rectum.	Total length of the Intestinal Canal.	Ratio of the length of the Body to the Small Intestines.
Fourmilier, C. }	0.162	0.519	2 Cœc.	0.081	0.608	:: 1 : 3.8
Echidna, C. . .	0.370	2.250	0.022	0.580	2.830	:: 1 : 7.8
Ornithorync. C. }	0.215	0.851	0.020	0.243	1.114	:: 1 : 5.2
Ornithorync. }	0.410	1.000	0.023	0.256	1.256	
R. K. }	16½ in.	39 inch.	1 inch nearly	10 inch.	49 inch. 50 cœc. includ.	

It is evident, I think, that the viscus called *cœcum*, in the Ornithorynchus and Echidna, is merely an *appendix vermiformis*. A number of dark-coloured glands are situated at the base of this appendix, and betwixt its tunics.

* The spleen seemed to me to be bilobular, and measured nearly 4½ inches in length; it was regular as to situation.

The internal lamina of the small intestines is known to be very peculiar; it forms a number of circular and parallel laminae close to each other, which diminish greatly the diameter of the canal. They are so incredibly numerous, as to give to the internal lamina of the intestines an extent, which I should scarcely think to be equalled comparatively in any other animal. These folds disappear near the termination of the small intestines in the colon. The peculiarities in the termination of the rectum, in the structure of the cloaca, and anus, have been already noticed; the most ample details relative to this part of the anatomy of the animal, and more particularly as regards the distribution of the suspensor muscle of the cloaca, as being more connected with a systematic work, will be found in the third volume of the *Anatomie Comparée*.

There is little peculiar in the structure of the trachea and lungs; the cartilaginous rings of the former are incomplete, as in the Mammalia. The trachea divides at an acute angle into two bronchial tubes, which pass immediately to each lung: the whole inner surface of the wind-pipe is studded with small transparent cartilaginous bodies, like millet-seeds. A number of small glandular bodies were found close to the upper part of the trachea, and precisely in the situation of the thyroid gland, nor could any other be discovered. The elasticity of the lungs is considerable, and the capacity of the chest shewed that the quantity of air taken in at each inspiration must be very great in proportion to the bulk of the animal.

There is undoubtedly something of an ornithological character in the structure of the heart; the valves placed at the entrance of the venæ cavæ into the right auricle seemed to me in a great measure muscular; and the right auriculo-ventricular valve was much more muscular than membranous. The bloodvessels had suffered so much by

maceration, that nothing could be made of this part of the dissection; the blood was every where coagulated into small, white, rounded, friable masses. The sinus placed between the liver and diaphragm, and which is known to be so large in most aquatic mammalia and in diving birds, was of considerable size in the *Ornithorynchus*. I need scarcely mention that the *foramen ovale* of the heart was closed, and that the *ductus arteriosus* had disappeared. The delicate tendinous-looking fibres, which pass from one paries of the right ventricle to the other, have not escaped the notice of M. CUVIER. After what I have said of the strictly mammiferous character of most of the organs described in this memoir, it may be hardly necessary to mention, that there existed no appearance whatever of an inferior larynx.

The numerous lymphatic glands found in various parts of the body, shew a very completely organised system; a string of lymphatic glands exist in the lower and anterior part of the neck; they are about the size of small peas, and of a dark-red colour, occasioned probably by the spirit in which the animal had been preserved. Numerous lymphatic glands are found likewise in the axilla, in the course of the jugular vein, and under the splenius muscle. The mesenteric glands were present, and sufficiently numerous.

The accompanying drawing of the abdominal viscera, by Mr WATSON, will enable the members of the Society to comprehend the general appearance and distribution of these organs.

MEMOIR III.

On the Kidneys, Urinary Bladder, and Organs of Generation, in the Male of the Ornithorynchus paradoxus.

THE kidneys had suffered so much by long maceration in spirits, that they were reduced to a pulpy, homogeneous mass, which gave way under the smallest pressure. Nothing could be made of their internal structure. It is stated in the *Anatomie Comparée*, that the medullary portion of the kidneys in the Echidna terminates by four papillæ, and that the pelvis of the kidney is confounded with the calices. Two ureters, very distinct in the Ornithorynchus, conduct the urine into a urinary bladder, thin in its parietes, but quite proportioned to the size of the animal. Air blown into the bladder by the blowpipe readily passed into the ureters, which I imagine to be rather a rare circumstance, as I do not remember to have found it so in any other animal. It is stated in the *Anatomie Comparée*, that the insertion of the ureters is placed in all animals at a certain distance from the neck of the bladder, excepting in the Echidna and Ornithorynchus, in which this insertion takes place beyond a little swelling (*bourrelet*), which seems to separate the bladder from the urethra, in such a way, that the ureters open into this latter canal, rather than into the bladder*; nevertheless, by inserting the blowpipe into

* On slitting up the urinary bladder somewhat farther than is represented in the drawing, I do not find this to be borne out by the appearance of the parts.

either of the ureters, the urinary bladder may be readily distended, and will remain so, though no compression of the urethra be employed.

I did not satisfactorily make out the supra-renal glands, but I am willing to ascribe this apparent exception to a very general law, to the state of the organs, which did not permit me to distinguish them from the kidneys.

The dissection of the organs of generation in the male *Ornithorynchus* was performed with a care proportioned to the usual intricacy of the parts, and to my knowledge of the very extraordinary contradictions existing in the writings of authors of the highest merit. The errors which anatomists had committed in their descriptions of the organs of defence, the poison-gland and spur, I am still inclined to consider as purely an omission on their part; for such was the distribution of the gland and duct, as exhibited in drawings to the Society, so easy its display, that the merest student in anatomy could, with sufficient patience, have made out the structure of the whole; but every anatomist knows, that the organs of generation are, generally speaking, the most complex of the frame, and require, in order to be unravelled, the most delicate dissection. The result of the inquiry is as follows.

The preparatory male organs, that is, the testicles, are placed in the abdomen near the kidneys, and they seemed to me to be constantly fixed there. The epididymis was proportionally large, but I could perceive nothing very remarkable in the *vasa deferentia*, which proceeded directly, without any dilatation, but rather a slight contraction, to terminate in the urethra, close to the entrance of the urinary bladder, into the same canal. The small longitudinal holes, by which they open into the urethra, are directed upwards, so that on introducing the tube of an ANEL'S syringe into the *vas deferens* near the epididymis,

the contained fluid passed out perpendicularly upwards, and not in the direction of the *vas deferens* itself: a small mucous papilla is placed near the orifice of each *vas deferens* *. But previous to our proceeding farther with the description of these organs, we must revert to the more external parts, and describe the cloaca itself.

It is well known that, externally, one orifice only is seen in the male ornithorynchus, which is to serve for the passage of the solid and liquid excrement, and of the penis. This orifice, situated at about $4\frac{1}{2}$ inches from the extremity of the tail, opens into a considerable cavity, generally called the *cloaca* †. When this cavity is slit open very carefully, we perceive three orifices of different dimensions, the uses of which are easily discovered. The highest up, which is also the largest, is the extremity of the rectum ‡; the second, at about $\frac{4}{10}$ ths of an inch from the former, is the opening of the urinary urethra; and the third, situated close to the former, passes into a sheath, in which the penis is entirely concealed. On the surface of the cloaca, near the termination of the rectum, are five or six small dark-coloured orifices, by which a few very small glands pour their secretions into the cloaca. If the urethra be now laid open from behind, that is, on the side which regards the

* The description taken at the time of the dissection, is as follows:—
“These ducts open close to the entrance of the urethra into the bladder, by a narrow linear aperture, the lower edge of which forms a sort of valve.”

† It is to be regretted that this name of *Cloaca* was adopted, taken as it is from the class of birds. The same structure exists in the beaver; and hence we see evidently the impropriety of the name “*Monotremes*,” given by some French naturalists to the Echidna and Ornithorynchus; under which appellation, they ought also to include the Castor tribe.

‡ The length of the cloaca, from its external orifice to the opening of the rectum, is about $1\frac{3}{10}$ th inches.

rectum, and the incision extended to the urinary bladder, there will now appear a circular orifice, situated at about $1\frac{4}{10}$ th inches from the opening into the bladder, and precisely $1\frac{2}{10}$ th inches from the orifices of the seminal ducts or *vasa deferentia*, which have been already described as entering the urethra close to the orifice of the bladder. The urethra itself is composed, as M. CUVIER well remarks, of a muscular portion only, included chiefly within the pelvis, and wants that which we call vascular. Its length from the openings of the *vasa deferentia* to the cloaca is about $1\frac{7}{10}$ th inches; it is united to the lower surface of the rectum, and inclosed with the last by a common constrictor muscle. A layer of muscular fibres, very strong throughout its whole extent, strengthens its parietes. The penis is withdrawn during its relaxed state into a particular pouch, and passes out at the time of erection by an orifice formed in the lower paries of the cloaca, under that which is peculiar to the urine. It is short, nearly cylindrical, and terminated on each side by two small rounded lobes corresponding with the glans penis, each in a great measure covered by its respective prepuce. When this prepuce is opened, four small conical papillæ, or nipples, appear on the surface of either glans. The surface of the penis is extremely rugose, and more particularly the anterior half; these rugosities terminate in very small conical papillæ, which might at first sight be mistaken for small bristles. If the sheath containing the penis be now slit up, the anatomy of the whole parts becomes distinct; the orifice on the lower surface of the urethra is proved to be the opening by which the seminal fluid passes from the common urethra into the canal of the penis, destined for the transmission of the seminal fluid, and that secreted by the glands of Cowper only. To make this evident, we must

refer to the situation of the glands of Cowper, which are placed close to the anus, outside the pelvis, and may readily be discovered by removing the skin of the perineum, and the muscles by which they are closely enveloped. These glands are comparatively of very large size, a fact readily accounted for, by considering that all the other organs generally found in animals as appendages to the male generative organs, such as prostate, seminal vesicles, accessory vesicles, &c. have disappeared. The duct proceeding from each of these glands is about an inch in length; they unite in a common cavity of small dimension, but distinct, placed close to the urethra, and into which enters the very short canal from the urethra, (whose orifice I have described as situated on the surface of the urethra, at about $1\frac{4}{10}$ th inches from the entrance of the urethra into the bladder, and $1\frac{2}{10}$ th inches from the termination of the *vasa deferentia* in the common urethra); and from which arises the long seminal canal or urethra of the penis, a duct destined for the transmission of the seminal fluid, and which entirely escaped the notice of the French anatomists. This duct or canal passes through the centre of the penis towards its anterior extremity, but divides, before terminating, into two ducts, destined for the separate bundles of papillæ, in which the bifurcated or double glans of the penis terminates. When the point of one of these papillæ is cut off, it is found to lead into a common cavity placed at the base of the small bundle of papillæ, and into which enters the seminal urethra already described. I now introduced the tube of a syringe into the open orifice of the papilla or nipple-like termination of the glans, which had been cut across, and found that the injected fluid returned by the orifices of the remaining papillæ, which had been left untouched, shewing that the resistance offered by

the seminal urethra contained within the body of the penis was greater than that offered by the papillæ themselves. When the pipe was pushed farther on, so as to enter the branch communicating with the main canal in the body of the penis, the fluid passed out most readily by a small orifice, which had been intentionally made in one of the ducts leading from Cowper's glands, shewing thereby the very free and direct communication between the seminal urethra of the penis and the ducts and glands of Cowper. Having now secured the duct of Cowper, so as to prevent the fluid passing out by the artificial opening, the whole of the fluid injected into the seminal urethra by the open papilla passed readily out by the common orifice on the lower surface of the urethra, the orifice by which the seminal fluid passes from the common urethra, to that contained within the body of the penis; but the fluid passed out in such a way as shewed that it had entered a common cavity, and that having no longer an exit by the ducts of Cowper, it became necessarily effused into the common urethra by the orifice above described. Lastly, having introduced the tube of the syringe into the orifice by which the seminal fluid passes out of the urinary urethra into the little cavity at the base of the penis, and compressing the opening around the nozzle of the tube, the fluid, whether water or quicksilver, readily passed out by all the papillæ situated in either glans of the penis.

The physiology of these very intricate organs becomes now exceedingly simple, and serves to throw considerable light on some of the accessory organs connected with those of generation. The whole of the accessory organs have disappeared, excepting the glands of Cowper,—a fact sufficient of itself to give an importance to these glands, which has hitherto been denied them. But they are moreover

connected with the seminal canal peculiar to the penis itself, and wholly unconnected, or nearly so, with the urinary or true urethra *. The passage and course of the seminal fluid may be readily understood : it is first poured into the common urethra, close to the bladder, by the *vasa deferentia* ; passes along this canal, until it reaches the surface of the urethra placed over the base of the penis, and where the opening of the seminal urethra of the penis is placed ; the remainder of the urinary canal being shut during erection, partly by muscular contraction, and partly by the efflux of blood into the body and base of the penis, no other passage is left for the seminal fluid, but that opening into the common cavity situated at the base of the penis, and into which are also poured the secretions from the glands of Cowper. But, as fluids readily pass from the ducts of these glands † into the seminal canal of the penis, and *vice versa*, so these secretions are readily transmitted with the seminal fluid along the seminal canal, to the four small conical papillæ situated on either glans, with which this animal is furnished. These papillæ, I have already stated, are hollow, and perforated at their extremity.

The penis is about an inch in length, in its relaxed state,

* In most animals, the ducts of Cowper's glands are so situated as to render it impossible for the seminal fluid to pass along these ducts towards the glands themselves. This is not absolutely the case with the same organs in the ornithorynchus, but I do not think that there arises from this the least doubt relative to the nature of these bodies called Cowper's Glands. I believe them to be essentially glandular ; and not receptacles for the seminal fluid, but destined to secrete a fluid of importance in the act of generation.

† By a strange oversight, the hedge-hog is stated in the *Anatomie Comparée*, not to have the glands of Cowper ; but the fact is, that they are remarkably large in that animal, whose generative organs merit a more careful analysis than has hitherto been made.

but it is evident that this measurement is not to be depended on. It terminates anteriorly on either side, by four white, conical elastic papillæ, resembling nipples. These may be considered as the terminating points of a double glans, though this, during the relaxed state, is by no means very distinct. When the penis is cut across, or opened into, it is found to possess a structure resembling the usual *corpora cavernosa*, and to be almost entirely composed of numerous vessels of comparatively large caliber. The parietes are dense and strong.

It will no doubt be expected of me, by many of the gentlemen who have done me the honour to listen to this, and to the preceding memoirs, that I should explain how the anatomy of parts apparently easily made out, should have been so singularly misunderstood by the French anatomists; and how, after the observations of Sir EVERARD HOME, which partly coincide with the above, the same errors should have been repeated in the "*Regne Animal*," published so late as 1817; that is, fifteen years after the publication of Sir EVERARD HOME'S observations in the *Transactions of the Royal Society of London*. The answering these questions I consider as a duty I owe as well to the Society before which I read this memoir, as to the distinguished naturalist who intrusted me with the dissection, and who, now for a long time, with unexampled liberality, has forwarded, to the utmost of his power, my researches into comparative anatomy.

To the first question I reply, that the account of the anatomy of the organs of generation in the male Ornithorhynchus, contained in the fifth volume of the *Anatomie Comparée*, page 104., could not have been taken from any dissection by the immortal author of that work, but from one performed by an assistant. I shall therefore omit copying it into this memoir, well aware that it will not re-

appear in a second edition of the work alluded to. The following brief account, extracted from the *Regne Animal*, will give a sufficient idea of the extent of the error:—"The third tribe of the *edentata* comprises the animals which Mr GEOFFROY designates by the name of "*Monotremes* *," because they have only one external opening for the seminal fluid, the urine, and other excrements. Their organs of generation present extraordinary anomalies. The *vasa deferentia* pass into the urethra, which opens into the cloaca, at the base of the penis, which is solid, and has not even a furrow to conduct the seminal fluid †."

On examining Plate LI., contained in the fifth volume of the *Anatomie Comparée*, we readily perceive the cause of these errors. In Fig. 3. the common urethra is left unopened; and the penis consequently appears without any aperture. The glands of Cowper are depicted with their ducts, but no mention is made of the mode in which they terminate, except by saying that they join the little canal or tube by which the urethra opens into the cloaca. In Fig. 2. the urethra has been opened in such a way as to destroy the entrance of the ducts of Cowper, the cavity into which they pass, and the orifices by which this cavity communicates with the true urethra and with the penis. It is true, that these engravings refer more particularly to the *Echidna*; but we know, from the dissections of others, that these animals do not differ essentially from each other.

It only remains for me to explain how these errors should have been repeated in the *Regne Animal*, published in 1817, and so long after better descriptions of these organs had been given to the world, in the Transactions of

* I have already remarked on the impropriety of this name.

† Tom. i. p. 224.

the Royal Society of London. The only reasons I have yet found out for this omission are, that, in these "Observations," the urethra is said to open into the rectum *, which is not the case; and the two glands of Cowper are described as terminating by six or seven orifices upon the surface of the rectum, instead of which, these canals terminate in a small cavity which communicates with the urethra, and with the seminal canal of the penis. The anatomy and physiology of these glands have been in consequence entirely misunderstood; at the same time, the true situation and anatomy of the orifice by which the seminal fluid passes into the canal or duct of the penis, though described, is not depicted. In a subsequent paper on the anatomy of the *Ornithorynchus Hystrix*, contained in the same volume of the *Philosophical Transactions*, most of these errors have been corrected. The true anatomy of the glands and ducts of Cowper had been discovered, and this led to a more accurate description of the whole: but it must be evident, that these seemingly contradictory statements might have led the French naturalists to disregard dissections which, in other respects, were extremely accurate †. I shall endeavour to submit to the Society, at a future period, a few opinions relative to the place which the *Ornithorynchus* is entitled to, in the scale of animals. In the mean time, it must be evident, that the speculations relative to the analogy of the *Ornithorynchus* with birds, so far as regards the male organs of generation, are entirely erroneous.

* Page 79. 1802.

† I have caused drawings of the parts described in this memoir to be laid before the Society, which, in addition to the diagram, and the inspection of the parts themselves, will, I trust, render the anatomy of the whole sufficiently distinct. The engraving (Plate V.) is from a pencil sketch by Mr THOMSON.

MEMOIR IV.

On the Osseous, Muscular, and Nervous Systems of the Ornithorynchus paradoxus.

I EXPERIENCED the greatest difficulty in drawing up the following memoir on the bones and muscles, because it is in these, and more particularly in the former, that the Ornithorynchus deviates most from the usual structure of the Mammalia, and approaches nearest to the class of Reptiles. Moreover, in order to have examined the osteology of the head minutely and accurately, it was necessary to have suffered the head to macerate so long as to present all the sutures in their most distinct state. Now, this I was unwilling to risk with the single specimen in my possession. Lastly, it is evident from the state of the bones, and more particularly from the obliteration of the sutures of the cranium, that the animal had arrived at its full growth, and consequently was unfit, in certain respects, for the purpose of osteological inquiries. I was obliged, therefore, to content myself with a general and rather superficial view of these very important organs.

From the previous description of the organs of sense, and from the skeleton which I have the honour to submit to the Society, for the inspection of the members, the general elongated form of the head will be readily understood. The extension of the superior maxillary and intermaxillary bones is very remarkable. The zygomatic arch is broad and strong; but the osseous orbit, as in most other animals, is incomplete. The prolongation of the nares backwards,

and the great comparative size of the superior maxillary bones, seem to me to have lessened the importance of the palate-bones in the formation of the floor of the nostrils, and to have reduced the pterygoid processes of the sphenoidal bones to a rudimentary state, by throwing them out laterally, so that they are articulated with the upper maxillary bones by a hinge-like joint, capable of considerable motion. They are placed horizontally; that is, on the same line with the osseous palate, and are connected with the *malleus* in the manner described in a former memoir.

The cranium is articulated to the spinal column by two large condyles. The cervical vertebræ are seven in number, and thus shew a decided mammiferous character. The *atlas* is very large, and its processes strongly marked. The same observation may be applied to the *dentata*; and, more particularly, to its spinous processes. The remaining cervical vertebræ gradually decrease in size: the development of these vertebræ corresponds with the great strength of the muscles which arise from, or are connected with, their processes. The total number of vertebræ is forty-nine; of which seven are cervical; seventeen strictly dorsal, having ribs implanted into them; one lumbar; three sacral, articulated with the *ossa ilii*; and twenty-one caudal. The spinous processes of the dorsal vertebræ are much sloped towards the tail. The four anterior dorsal vertebræ have spinous processes on their interior surface, which are strong, of a square form, and gently sloped towards the neck. The same processes in the last dorsal, in the lumbar, and in about one-half the caudal vertebræ, are strong and vertical. In the remaining caudal vertebræ, they gradually decrease in strength, and slope towards the back. The caudal vertebræ strongly resemble those of the beaver, in the length and breadth of the transverse processes, and in having spinous processes placed on their inferior surface.

Of the ribs, which are seventeen in number, the first is attached to the sternum, apparently by cartilage; the succeeding four by bone, the cartilage being removed towards the centre of the rib; the succeeding ten terminate in broad osseous plates, extensively moveable, though connected with each other. Of the two remaining to be described, one is attached by ligament to the preceding rib, but they do not terminate in bony plates, and may be considered as floating ribs.

There is perhaps nothing more singular in the structure of the ornithorynchus, than the formation of the clavicle and scapula, which have altogether the appearance of the same bones in reptiles; and, as seems to me, more particularly in the animal called Tupinambis. From a scarcity of specimens in my possession, I am by no means prepared to enter on the inquiry to which class precisely the bones composing this very complicated clavicle and scapula ought to be referred. We readily distinguish a clavicle composed of a broad flat portion, articulated with the anterior, that is, upper edge of the sternum, and a small horizontal branch, evidently incomplete in its mesial part, and intimately connected with a parallel branch of the flattened portion of the clavicle*. These latter branches are joined with that por-

* The fossil animal described in the Philosophical Transactions for 1818, has a sternum and clavicle very analogous to the Ornithorynchus. This analogy, which has been very beautifully pointed out by Sir E. HOME and Mr CLIFT, is even more perfect than these gentlemen suppose; for I perceive, by the accompanying drawing (Phil. Trans. 1818, Part I. Plate II.) that the two small bones just described by me, as being present in the Ornithorynchus paradoxus, have escaped their observation. Hence the distinguishing marks between the bones composing the sternum and shoulder in these two animals does not consist in the fossil animal having a clavicular bone, which is wanting in the Ornithorynchus paradoxus, but rather in this clavicular bone or *fourchette* being united throughout its whole length with the scapula in the one, and with the clavicle or upper bone of the sternum

tion of the scapula which, from a very obvious analogy, I should call its acromial process. The scapula itself is shaped like that of a bird; and, in addition to its acromial process, by which it is connected to the clavicle, sends a very strong process backwards and inwards, towards the upper bone of the sternum, with which it is articulated: and it is even somewhat connected with the bone which I have called the flat portion of the clavicle. Along the whole inner margin of the process of the scapula joining the sternum (and which bears so great a resemblance to the true clavicle in birds), is placed a thin flat semicircular plate of bone, which, running up behind the broad clavicular bone, performs extensive circular motions during the action of the anterior extremities, as well by reason of the laxity of its connection with the clavicular bones, as by its loose hinge-like joint with the scapula. It is exceedingly difficult to decide on a name for this very singular bone, and to trace its analogies throughout the range of vertebral animals. In the mean time, until that be satisfactorily done, it must be evident, I think, to all, that its analogies ought to be sought for in the class of Reptiles: for, in most species of this class, there would seem to prevail an analogous structure, though occasionally very complex, and with difficulty to be made out. The extreme laxity of the articulation of the scapula in the Ornithorynchus, and its anomalous bone or process,

in the other. There are several other differences sufficiently remarkable. The peculiar flat semicircular bone forms a great portion of the glenoidal cavity in the fossil animal, and the scapula does not seem to be in any way articulated with the sternum, unless we consider the bone marked *b* (see the drawing) as the anterior bone of the sternum. Neither of these circumstances holds with regard to the Ornithorynchus paradoxus. There is a considerable resemblance between the shoulder-bones of the fossil animal and the common Chameleon, a skeleton of which I have placed before the Society.

explain sufficiently its functions; for, by this, the humeral part of either extremities is enabled to approach the other; and thus the whole of the anterior extremities can approximate much more than if the articulation of the lower process of the scapula had been attached to the sternum with the same degree of fixity as the upper or acromial process. In addition to the extensive rotatory motion which the distance of the acromion from the joint enables the humerus, and consequently the extremity, to perform, another kind of motion is performed, by means of a moveable articulation, found only in reptiles and fishes; I mean the sliding semicircular motion performed by the squamous part of the scapula upon the flattened portion of the clavicle*.

Some exceedingly ingenious attempts have been made to reduce the whole assemblage of bones composing the shoulder, clavicle, and sternum of the ornithorynchus to their analogous bones in birds and reptiles, but these attempts have not as yet been very successful, and the reason of this appears to be sufficiently obvious: for the bones of the sternum in reptiles are in general so anomalous as to defy classification, founded on analogy with other vertebral animals; whilst the analogies endeavoured to be established between the same parts in birds, and the mammalia, are by no means generally agreed to. In the ornithorynchus, we find, as it were, a compound of the three classes Mammalia, Aves and Reptilia. The dorsal part of the scapula resembles the same part in birds. The acromial process approaches that of the Mammalia; the glenoid cavity of the joint is placed at the union of the dorsal part of the scapula and the process extending to the sternum, which pro-

* In Plate V., will be found an accurate sketch of the assemblage of bones composing the shoulder and sternum of the Ornithorynchus, accompanied by one of the fossil animal alluded to in the text.

cess bears a close resemblance to the clavicle in birds; whilst the bones I have called Clavicle (three in number) are very analogous to the *fork* or *merry-thought* found in the same class of animals. With regard to the flat, moving, squamous bones situated behind the clavicle, and fixed to the sternal portion of the scapula, it is evident that their analogy is to be found only amongst reptiles. Perhaps, then, we might say, that the scapula has a dorsal plate and acromial and coracoid processes; that the acromial is tolerably regular as to situation and distribution, but that the coracoid, which, in Man, is rudimentary, is, in the *Ornithorynchus*, extended to the sternum*. We may next suppose the flat and broad portion of what I have hitherto called the clavicle, to be actually the anterior bone of the sternum; which, in this view, would come to be composed of five instead of three bones, placed the one immediately behind the other †, whilst the two thin and long bones firmly united to the anterior extremities of them, might be considered as analogous to the merry-thought in birds ‡. But there still remain to be accounted for, the osseous squamous plates, articulated with what I have just called the coracoid process of the scapula, and which M. St. HILAIRE considers as analogous to a small process of bone found immediately at the base of the true clavicle in birds, and to

* I ought to mention here, that that most excellent naturalist, M. GEOFFROY ST HILAIRE, considers the bone we call Clavicle in birds, as the coracoid process of the scapula; which idea is very beautifully supported by the form of the scapula in the *Ornithorynchus*.

† The fourth of these, counting from the epigastrium, is constantly divided into two in the *Ornithorynchus*.

‡ These are considered by M. GEOFFROY as the acromial processes of the scapula greatly elongated. It is to be remarked, however, that they are connected to the scapula *not by bone*, but by a very perfect moveable articulation, with a capsule,—and I am not sure that M. GEOFFROY is aware of this fact.

which he has given the name of "*Os Episternal.*" The principal distinguishing characteristic of this "*os episternal,*" is said to be, that it is placed always on the coracoid process; but this rule does not seem to hold true with regard to the frog, and perhaps with some other reptiles. We are compelled, therefore, to consider these bones as strictly belonging to the class Reptiles, and that their presence in the Ornithorynchus may depend either on the extraordinary anomalies which undoubtedly exist in this animal, or that it is connected with the aquatic habits of the animal, and intended to facilitate the movements of the anterior extremity, and to extend them so far as was consistent with the safety of the shoulder-joint. In short, it seems intended to permit the coracoid process of the scapula considerably to change its position, and to approximate or recede from its fellow, at the will of the animal, and thereby very much to extend the movements of the anterior extremity, and to convert it into an oar of the most perfect description.

It is sufficiently curious, that, whilst so much has been written to prove the analogy of the bones entering into the composition of the sternum, clavicle, and scapula throughout the animal kingdom, no attempt, so far as I know, has been made to name the bones which may be supposed analogous to the marsupial bones of the pelvis, and which are not peculiar to the ornithorynchus, but found in a very considerable number of animals *. The truth is, that these bones are quite peculiar to the class, and created by Nature apparently for a particular purpose, viz. of supporting the marsupium, or abdominal pouch, in which the young of these animals are contained, from the period of their imperfect birth, until they are capable of providing for

* Since writing the above, I find that an attempt has been made to compare the marsupial bones with the *os peniale* found in certain animals, as the dog, &c.

their own wants and safety. Yet these bones are present in the *Ornithorynchus* and *Echidna*, which are said not to have a marsupium; and the fact has been brought forward by Professor BLUMENBACH, as a proof of what he calls an “union of the teleological and mechanical principles in the function of generation,—principles which were formerly thought to be incompatible with each other.” The formation of this anomalous pair of bones (he observes) for the purpose of supporting the abdominal pouch of the female, is a clear instance of the teleological principle; that is, it shews a peculiar part formed for a certain purpose. Their existence in the male (and of course in the *Ornithorynchus*) where the end and purpose of their formation do not exist, shews the mechanical principle, as if they had been merely framed in compliance with some general model for the structure of the species*.

The bones of the extremities may be described together, as they so much resemble each other. The *os humeri* is strong, and peculiarly formed with regard to its processes, which are very prominent, and afford a powerful point of attachment to the various muscles; it is perforated near its radial extremity, as in many other animals, for the transmission of bloodvessels. The olecranon of the ulna is much developed, and of considerable breadth. In the posterior extremity, the fibula bears a strong resemblance to the ulna, and has a remarkably strong process for the insertion of muscles extending upwards towards the pelvis and tail. The tarsal and metatarsal and digital bones of the posterior extremities, and the corresponding bones of the anterior extremity, do not require any particular description. We shall therefore only remark, that, in the construction and perfect organisation of the bones of the extremities, the *Ornithorynchus* differs most remarkably from Birds and Reptiles.

* A Short System of Comparative Anatomy, p. 41.

I intend saying but little on the muscular system, because the muscles being simply the moving powers of the bones, an inspection of the skeleton will readily explain any peculiarities which may exist in the former.

The muscles situated on the neck, connecting the head, trunk, and cervical vertebræ, are very powerful, and seemed to me regular. Those of the back and tail are distributed much as in the Beaver. The marsupial bones have two muscles connected with them, which proceed from their whole inner edge upwards towards the sternum: these may be considered as analogous to the *pyramidales* in man. The *recti*, and other abdominal muscles, are present, and regular. The pectoral muscles, which are divided into two, arise from the whole upper edge and mesial line of the complex clavicles, and from the *linea alba* of the abdomen, nearly as low as the pubis: these muscles are inserted separately into the humerus; the superior or anterior one is perforated by a strong muscle (the deltoid), arising from the dorsum and acromial process of the scapula, to be inserted into the os humeri.

When the external pectoral muscles are removed, two broad muscles are found immediately beneath, arising from the whole surface of the peculiar squamous bone (described at considerable length above, under the name of the Squamous Process of the Scapula;) and inserted the one into the inner tuberosity of the os humeri; the other into the same bone, but much nearer the fore-arm. These may be considered as analogous to the coraco-brachialis of the Mammalia; or we may prefer giving the name of Coraco-brachialis to two long muscles of a rounded form, which arise from the coracoid process itself, and are inserted into the *os humeri*. From the same squamous bone, and from the semi-circular edge of the peculiar clavicle, arises a long slip of muscle, which, proceeding downwards, is inserted into the

aponeurosis covering the rectus muscle, nearly midway betwixt the sternum and pubes.

Another short but powerful muscle arises from the whole inner surface of the squamous process of the scapula, and is inserted most extensively into the broad inner surface of the *os humeri*; and close to it is a muscle having a similar origin, but is inserted into the first rib*. The muscles connecting the dorsal portion of the scapula with the spine, and the former with the *os humeri*, are tolerably regular, and at least as numerous as in any of the Mammalia. The extensors of the fore-arm seemed to me powerful: the same observation is applicable to the other muscles of the fore-arm and leg, the extent and nature of whose motions may be judged of, by observing the bones, and, more particularly, the development of the radius and tibia.

The sterno-mastoid is fixed into the small horizontal bone, which M. GEOFFROY calls the acromial process, and into the horizontal branch of the clavicle immediately connected with it. It thus becomes either a sterno-mastoid, cleido-mastoid, or scapulo-mastoid muscle, according to the view adopted relative to these bones: at the same time, the *omo-hyoideus*, which is much more developed proportionally than in the human subject, arises from the scapula, close to where it is connected with the horizontal branch of the clavicle, and following the regular course of the muscle is inserted into the *os hyoides*.

These are all the details relative to the muscles with which I have thought fit to trouble the Society.

The brief account I propose giving the Society of the Nervous System, cannot be expected to be either minute

* From the number and strength of the muscles connected with this anomalous bone, may be judged its importance in the movements of the shoulder, and its influence even over the thorax itself.

or accurate, since I had no opportunity of viewing the brain and spinal marrow, those great central organs of sensation, with which all the nerves of the body, directly or indirectly, communicate; and I could not trace any nerve very completely to its termination, for fear of destroying other important parts.

The first, second, third, fourth, and sixth pairs of cerebral nerves, I either did not see at all, or only in a partial way. I have not the least doubt of their being quite regular in their distribution. The fifth has been already described, whilst speaking of the organs of touch and taste. The auditory nerve was not seen; the facial, which I prefer calling by the name of the *portio dura* of the seventh pair, to any other yet invented, was regular as to its presence and size. Its distribution was chiefly to the cheek-pouches, and back and side of the head, around the external orifice of the ears; but it did not approach the nostrils, for a very obvious anatomical reason, and, consequently, in this animal at least, has nothing to do with the organs of respiration. The eighth, or *par vagum*, the ninth, with the nerve called the *descendens noni*, the spinal accessory, and the cervical portion of the sympathetic nerve, were very strictly as in the Mammalia. I also remarked, that the sympathetic nerve, in its passage down the neck, was more distinctly marked and detached from the *par vagum*, than in many animals supposed to stand much higher in the scale of the animal creation. The superior cervical ganglion was very small, but at this point the sympathetic branch united with the *par vagum*. Immediately above this union the nerves were again distinct, and three branches belonging to the sympathetic nerve could be traced proceeding towards the fifth pair. The inferior cervical ganglion was large, but there did not exist any middle one. The cervical nerves were large and regular. No-

thing struck me more forcibly than this strict accordance of the nervous system with that of the Mammalia in general: the same observation is applicable to the bones and muscles, so that the analogy supposed to exist between the Ornithorynchus and Birds is reduced to the resemblance of the ossicula of the ear, and to the female organs of generation, which I have not as yet had an opportunity of examining.

I could easily have swelled out these memoirs to a much greater length, by entering into the minute anatomical details, which were carefully taken down during the dissection; but I cannot think that these would in the least interest the Society, since they do not lead to any general physiological results.



Explanation of Plate V.

- Fig. 1. Gives a front view, from nature, of the complex clavicle and scapulæ of the Ornithorynchus. The bones are represented of their natural size.
- a*, Marks the upper or anterior bones of the sternum, the Entosternal of Mons. GEOFFROY ST HILAIRE. To these bones the anterior pair of ribs are attached at *a*.
 - b*, The clavicle, (*Furculaire* of M. GEOFFROY.)
 - c*, The process of the scapula joining the clavicle, and which I consider, with M. GEOFFROY, as analogous to the coracoid process in Man, and the true clavicles in Birds.
 - d*, The glenoid cavity of the shoulder-joint.
 - e*, The peculiar, flat, and highly moveable bone, articulated by a moveable joint, with the coracoid process of the scapula; it passes up behind the clavicle, and its upper or anterior edge may be seen at *e*, *e*. It is this bone which performs an ex-

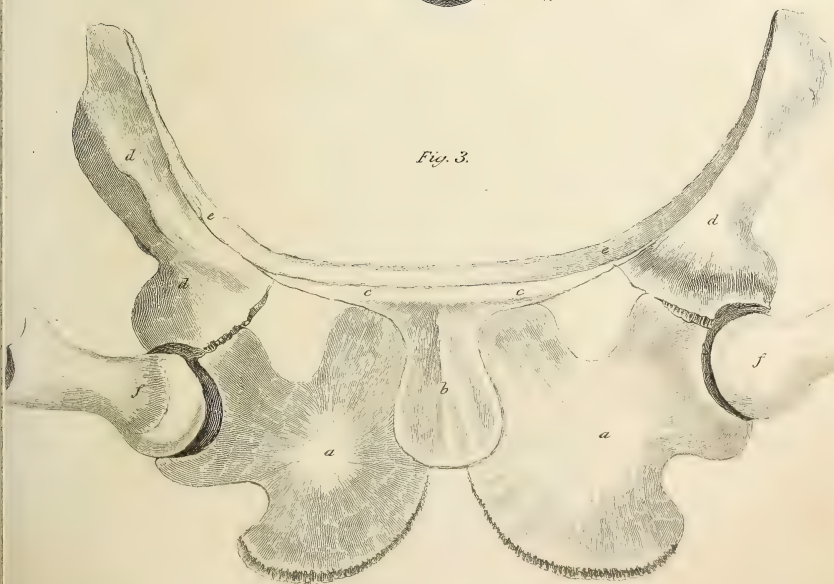
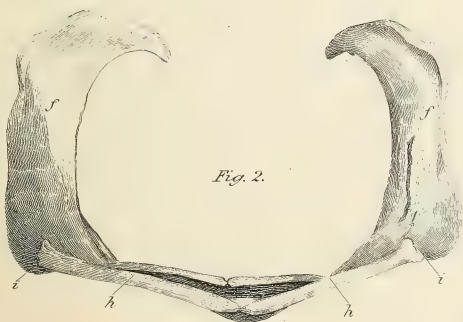
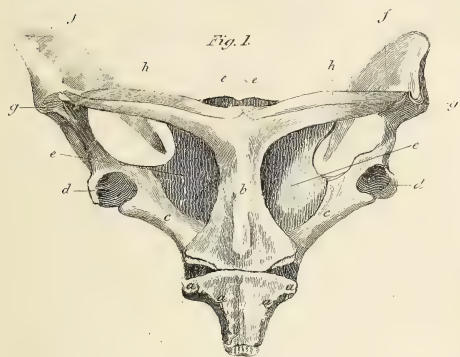



tensive sweeping semicircular motion, and thereby enables the whole shoulder to alter very much its relative situation to the clavicle and sternum. It is the episternal of GÉOFFROY.

f, The dorsal portion of the scapula.

g, The little process, I have considered in the text as the *acromion scapulæ*. Here there is a moveable articulation of the clavicle *b*, and of two bones marked *h, h*, considered by me as analogous to the *fourchette* or *merry-thought* in birds. They are named Acromial Processes by GÉOFFROY. They are intimately united to the horizontal branch of the clavicle, and are articulated to the scapula, by means of a joint admitting a certain degree of motion. They have been omitted in the very spirited drawing of this part of the osseous system of the *Ornithorynchus paradoxus*, by Mr CLIFT, and published in the Philosophical Transactions for 1792.

2. Represents an anterior view of these bones; the letters *h* and *f* refer, as in the preceding figures, to the merry-thought and dorsal portion of the scapula; *i* marks the articulation between these bones at the part I have called *acromion*.
 3. Is taken from a figure in the Philosophical Transactions for 1818, Part I. Plate II. It is a representation of the bones entering into the composition of the shoulder, in a fossil animal described in the same work.
- a*, Two flat bones, peculiar to the sternum of this animal and the *Ornithorynchus*.
- b*, A flat bone, behind which is concealed the union of the edges of the two flat bones just mentioned. (This is considered by Sir E. HOME as the sternum of the animal, and is called so at *c*.)

- c, c*, Two processes from this bone, by means of which it is united to the scapulæ.
- d, d*, The scapulæ, which, united to the flat bones, form the glenoidal cavities of the shoulder-joints.
- e, e*, A slender curved bone, crossing the upper end of the sternum, and uniting the scapulæ to each other.
- f*, Os humeri.
4. Engraved from a pencil sketch, by Mr R. M'INNES, of the organs of generation in the male Ornithorhynchus.
- a*, The testicles.
- b*, The epididymis.
- c*, The bladder of urine.
- d*, The orifices of the seminal vessels (*vasa deferentia*) entering the urethra close to the opening into the bladder.
- e*, The urethra laid open.
- f*, The rectum; partly laid open at *g*.
- h*, The common surface of the cloaca slit up.
- i*, The opening by which the seminal fluid passes into the canal peculiar to the penis. This opening leads into a small cavity, into which enter the ducts from Cowper's glands, marked *k*, and from which arises the canal of the penis, admitting the seminal fluid, and that from Cowper's glands only.
- l*, The orifices of a number of small blackish mucous glands, which pour their fluids into the cloaca, close to the entrance of the rectum.
- m*, The body of the penis.
- n*, Marks the four small conical papillæ in which each glans terminates: these papillæ are hollow and pervious.

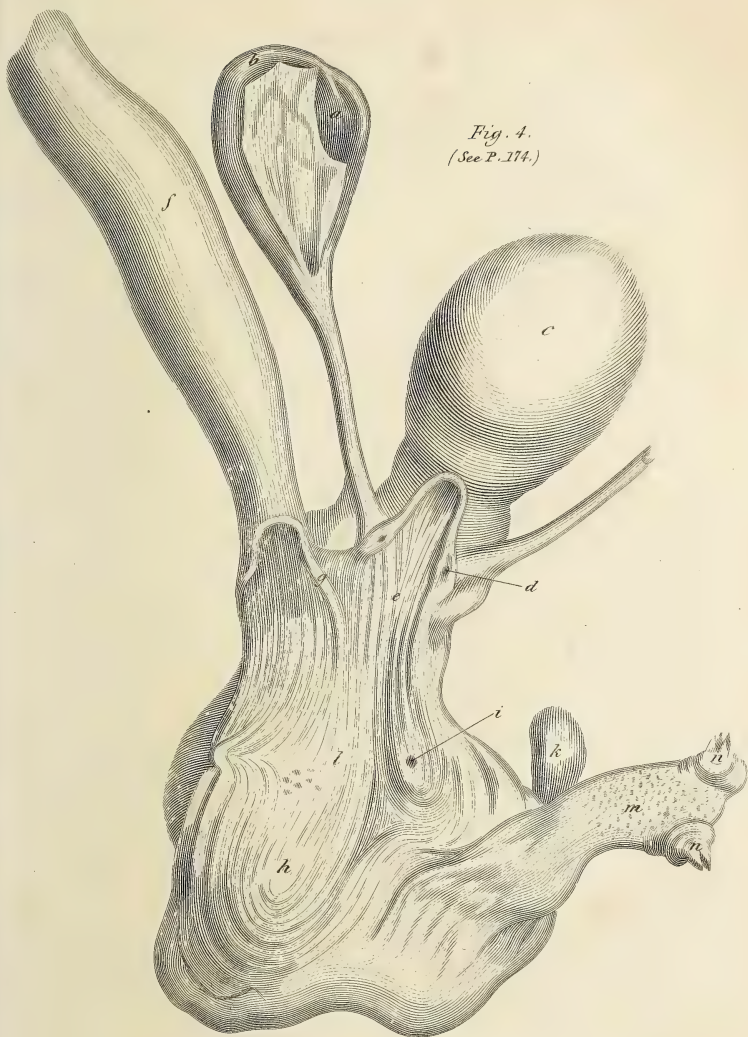
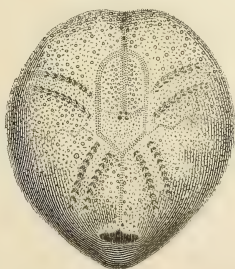

Fig. 4.
(See P. 174.)

Spatangus ovatus





IX.—*An Account of a series of Thermometrical Observations, made hourly at Leith, during Twenty-four Successive Hours, and once every Month, from July 1822 to July 1823.*

By Mr JOHN COLDSTREAM.

(*Read 14th July 1823.*)

THE best and most valuable plan for the keeping of a thermometrical register, would undoubtedly be, to make observations at the end of short and regular intervals; for instance, every hour, or every two hours: because, the first and main object of the meteorologist, in keeping such registers, being to ascertain the average temperature of each day, as nearly as possible, it is evident, he cannot fix this point better, than by calculating the mean of very frequent observations, which will, of course, always approach nearer and nearer to the true average temperature of the whole twenty-four hours, in proportion to the number of observations.

However desirable the accomplishment of such a plan might be, yet its inconvenience, nay, general impracticability, is abundantly obvious.

It becomes, therefore, a matter of no small moment, to find out, at what hour or hours, the average temperature of the day, for the most part, occurs; that the meteorologist may be furnished with accurate information, for the proper conducting of his observations, and a long-agitated question in physical science, finally answered.

During those ages which immediately followed the invention of the thermometer, philosophers were guided by mere whim and caprice, in settling their hours for observing the indications of that instrument. But, since the great subject of the mean temperature of the globe has been started for discussion, and since the high importance of meteorological registrations to the best interests of mankind has been generally acknowledged, men of science have all agreed in admitting the necessity there is for their observations being at least synchronous one with the other. This is, however, not sufficient for the purposes of philosophy. If the mean temperature of the day is not ascertained by all, the synchronism of the observations matters but little. Many different hours have been proposed as the best suited for the attainment of the object desired, but perhaps too frequently on unstable grounds. After the maximum and minimum thermometers had deservedly come into general use, the hours of 10 A. M. and 10 P. M. were confidently stated as the preferable ones for observation; the mean of these agreeing with the mean of the extremes indicated by the instruments alluded to; that, again, being supposed by many, palpably to demonstrate the true average temperature of the twenty-four hours.

The only mode, however, that can be adopted, definitively to settle the disputed point, plainly is, to make a continued series of observations for a considerable period of time, at the lapse of very short intervals,—as for two or three years, at the end of every half hour, day and night,—

a task that might be accomplished, in particular situations, by the co-operation of many, although it never could be done by a single individual.

As far as our information extends, a prolonged series of this kind has never been instituted in Britain; but it is proposed, at present, to give an account of such a set of observations, on a small scale, lately carried on in Leith, and which have been productive of results, that prove well the interest and importance of the subject.

In the twelfth number of the Edinburgh Philosophical Journal, Dr BREWSTER, at the conclusion of some remarks on a set of like observations carried on by Dr DEWEY, at Williamston, in the United States of America, mentioned, that “it would be desirable to possess a series of observations made in Scotland for every hour of the day, for a small number of days;” and that “he begged leave earnestly to suggest such a series of experiments, to some of those active meteorologists who have undertaken to keep regular registers of the thermometer in Scotland*.”

Immediately on reading the above quoted suggestion, I set about a series of hourly observations, and continued them for six successive days, beginning on the 1st April 1822. Not being so well satisfied with the manner in which this series was conducted, I take no notice at present of the results obtained. Soon after, I began those observations which form the subject of the present communication. I proposed to myself to observe the thermometer for twenty-four successive hours every month, commencing on the 1st July, and this plan, with the occasional assistance of a friend, I continued regularly throughout the year.

The following is a copy of the journal of this series.

* It appears from the notice of Dr DEWEY's paper, here alluded to, that he observed for thirty days, at different times of the year, twenty-four times a-day.

JUNE 30.—JULY 1. 1892.			AUGUST 1. 1892.		
HOUR.	THER.	WEATHER, &c.	HOUR.	THER.	WEATHER, &c.
8 P. M.	57,0	Dullish; strong wind.	1 A. M.	48,0	Clear, fine. Moon obsc.
9 —	56,0	Do. do. pleasant.	2 —	48,0	Rather dull.
10 —	56,0	Wind incr.; large cum.	3 —	47,0	Clear cloudless dawn.
11 —	54,0	Dull; do. do.	4 —	46,0	Very fine, sunshine.
12 —	52,5	Do. do. do.	5 —	46,0	Do. do.
1 A. M.	52,5	Do. do. do.	6 —	48,0	Do. do.
2 —	52,0	Clear dawn; very fine.	7 —	52,0	Do. do.
3 —	51,0	Do. do.	8 —	54,0	Do. do.
4 —	52,0	Sunshine, wind incr.	9 —	56,0	Do. do.
5 —	52,0	Do. very fine.	10 —	57,0	Do. do.
6 —	54,0	Rather dull.	11 —	59,5	Do. do.
7 —	56,0	Fine, pleasant.	12 —	64,0	Cloudy, dull.
8 —	58,0	Dullish.	1 P. M.	64,0	Sunshine.
9 —	60,0	Bright sunshine, fine.	2 —	62,0	Cloudy; very pleasant.
10 —	62,0	Do. do.	3 —	67,5	Bright sunshine,
11 —	63,5	Dullish.	4 —	69,0	Do.
12 —	63,0	Cloudy, pleasant.	5 —	67,2	Cloudy.
1 P. M.	64,0	Do. do.	6 —	63,0	Sunshine.
2 —	64,0	Do. do.	7 —	62,0	Do.
3 —	64,0	Do. do.	8 —	58,0	Do.
4 —	69,0	Fine sunshine.	9 —	56,0	Clear, pleasant.
5 —	64,0	Do. do.	10 —	54,0	Bright moonshine,
6 —	63,0	Do. do.	11 —	51,5	Do.
7 —	60,0	Dullish, very pleasant.	12 —	48,5	Do.
RESULTS.			RESULTS.		
1. Average temperature of the 24 hours, - - - 58,31+			1. Average temperature of the 24 hours, - - - 56,17+		
2. Maximum (at 4 p. m.) 69,00			2. Maximum (at 4 p. m.) - 69,00		
3. Minimum (at 3 a. m.) 51,00			3. Minimum (at 4 a. m.) - 46,00		
4. Range of observed temp. 18,00			4. Range of observed temp. - 23,00		
5. Mean of the extremes, 60,00			5. Mean of the extremes, - 57,50		
6. Average rise per hour, 2,10			6. Average rise per hour, - 2,318		
7. Average fall do. - 2,62			7. Average fall do. - - 2,336		
8. Average temperature of the day occurred at 8 a. m. and 8 p. m.			8. Average temperature of the day occurred at 9 a. m. and 9 p. m.		
NOTE—Sun rose at 3 h. 20 min. a. m. set 8 h. 46 min. p. m.			NOTE—Sun rose at 4 h. 5 min. a. m. set 8 h. 7 min. p. m.		

SEPTEMBER 2. 1822.			OCTOBER 1. 1822.		
HOUR.	THER.	WEATHER, &c.	HOUR.	THER.	WEATHER, &c.
1 A. M.	60,0	Clear moonshine.	1 A. M.	50,0	Dullish, moon obsc.
2 —	60,5	Dull; flying cumuli.	2 —	50,5	Do. do.
3 —	60,5	Do., wind incr., SW.	3 —	51,0	Do. do.
4 —	60,0	Dullish, pleasant.	4 —	50,0	Do. do.
5 —	60,0	Very pleas., wind str.	5 —	49,8	Do. do.
6 —	60,5	Dullish, fine.	6 —	50,0	Do. do.
7 —	61,0	Do. do.	7 —	50,0	Sunshine.
8 —	61,0	Do. do.	8 —	52,4	Dull. Cumuli.
9 —	64,0	Bright sunshine.	9 —	54,0	Very dull. Wind E b N.
10 —	66,0	Do.	10 —	53,8	Do. do.
11 —	66,0	Do.	11 —	54,0	A little rain.
12 —	64,0	Dull, windy, not unpl.	12 —	56,0	Dullish, pleasant.
1 P. M.	63,0	Do. do.	1 P. M.	57,5	Do. do.
2 —	64,0	Do. do.	2 —	58,0	Do. do.
3 —	66,5	Sunshine, fine.	3 —	56,5	Do. do.
4 —	65,0	Rather dull.	4 —	56,0	Clear, fine.
5 —	60,0	Do.	5 —	54,0	Dullish; strati,
6 —	58,0	Do. Wind abated.	6 —	53,5	Do. do.
7 —	56,5	Dullish, fine.	7 —	53,0	Do. intervals of sunsh.
8 —	56,0	Moon obscured.	8 —	52,0	Very fine, moon bright.
9 —	54,1	Clear & bright moonsh.	9 —	52,0	Do: dull at intervals.
10 —	54,0	Do. do.	10 —	52,0	Do, clear moonshine.
11 —	53,0	Dullish, fine.	11 —	50,5	Do. do.
12 —	53,0	Clear moonshine.	12 —	49,8	Do. do.
RESULTS.			RESULTS.		
1. Average temperature of the 24 hours, - - - 60,27+			1. Average temperature of the 24 hours, - - - 52,75		
2. Maximum (at 3 p. m.) 66,50			2. Maximum (2 p. m.) 58,00		
3. Minimum (at 11 p. m.) 53,00			3. Minimum (5 a. m.) - 49,80		
4. Range of observed temper. 13,50			4. Range of observed temper. 8,20		
5. Mean of the extremes, 59,75			5. Mean of the extremes, 53,90		
6. Average rise per hour, 1,42+			6. Average rise per hour, 1,04		
7. Average fall per do. - 4,6			7. Average fall per hour, 0,92		
8. Average temperature of the day oc- cured at 6 a. m. and 5 p. m.			8. Average temperature of the day oc- curred at 8 a. m. and 8 p. m.		
NOTE—Sun rose at 5 h. 7 min. a. m. set 6 52 p. m.			NOTE—Sun rose at 6 h. 4 min. a. m. set 5 36 p. m.		

NOVEMBER 1. 1822.			DECEMBER 1. 1822.		
HOUR.	THER.	WEATHER, &c.	HOUR.	THER.	WEATHER, &c.
1 A. M.	52,0	Dullish; strati.	1 A. M.	39,5	Very heavy rain, very
2 —	49,5	Clear moonshine.	2 —	40,0	Do. do. [dull-
3 —	50,0	Clear, wind increas.	3 —	40,0	Do. do.
4 —	49,0	Do. do.	4 —	40,0	Do. do.
5 —	48,0	Do. do.	5 —	41,0	Rain abated. Wind W.
6 —	48,0	Dullish.	6 —	40,0	Fair, wind continuing.
7 —	50,0	Do.	7 —	41,0	Do.; dullish
8 —	52,0	Clear sunshine.	8 —	41,0	Do. do.
9 —	54,5	Dullish, fine.	9 —	40,0	Clear, cumulo-strati.
10 —	56,0	Do. do.	10 —	45,0	Do.
11 —	56,5	Do. do.	11 —	44,0	Do. cirri, windy.
12 —	57,0	Do. do.	12 —	44,0	Dullish.
1 P. M.	58,0	Fine, interr. sunshine.	1 P. M.	44,5	Bright sunshine.
2 —	59,0	Dull, strat.	2 —	42,0	Rather dull.
3 —	59,5	Dullish, wind blowing	3 —	42,0	Clear, pleasant.
4 —	59,5	[hard from SW.	4 —	42,0	Dullish.
5 —	58,5	Do.; a little rain.	5 —	41,0	Do.
6 —	58,0	Do., wind increasing.	6 —	40,0	Do.
7 —	59,0	Intervals of moonsh.	7 —	39,5	Do.
8 —	59,5	Do. wind very strong.	8 —	39,5	Do.
9 —	60,5	Do. do.	9 —	39,0	Do. wind rather str.
10 —	60,5	Do. do.	10 —	39,5	Do.
11 —	60,0	Do. do.	11 —	40,0	Do.
12 —	60,0	Do. wind boisterous.	12 —	39,0	Do.

RESULTS.		RESULTS.	
1. Average temperature of the 24 hours, - - -	55,64+	1. Average temperature of the 24 hours, - - -	40,97
2. Maximum (9 p. m.)	60,50	2. Maximum (1 p. m.)	44,50
3. Minimum (5 a. m.)	48,00	3. Minimum (9 p. m.)	39,00
4. Range of observed temp.	12,50	4. Range of observed temp.	5,50
5. Mean of the extremes,	54,25	5. Mean of the extremes,	41,75
6. Average rise per hour,	1,29	6. Average rise per hour,	1,28
7. Average fall per hour,	1,07	7. Average fall per hour,	0,94
8. Average temperature of the day occurred at 10 a. m.		8. Average temperature of the day occurred at 8 a. m. and 5 p. m.	

NOTE—Sun rose 7 h. 9 min. a. m. set 4 h. 19 min. p. m.	NOTE—Sun rose 8 h. 11 min. a. m. set 3 h. 28 min. p. m.
---	--

JANUARY 1. 1823.			FEBRUARY 1. 1823.		
HOOR.	THER.	WEATHER, &c.	HOOR.	THER.	WEATHER, &c.
1 A. M.	32,0	Dull; wind gentle.	1 A. M.	36,5	Very dull, wind str.
2 —	32,0	Do. do.	2 —	36,5	Do. wind E.
3 —	32,0	Do. do.	3 —	36,5	Do. wind rising.
4 —	32,0	Do. do.	4 —	36,5	Do. do.
5 —	31,5	Do. do.	5 —	36,5	Do. wind very strong.
6 —	28,0	Clear moonshine, fine.	6 —	37,0	Do.
7 —	28,0	Do.	7 —	38,0	Dull.
8 —	28,0	Do. sunshine, pleasant	8 —	38,0	Do.
9 —	29,0	Do. do.	9 —	36,0	Do.
10 —	30,0	Do. do.	10 —	36,0	Large nimbi from E.
11 —	32,0	Dullish, pleasant.	11 —	36,0	Unpleasant, wind str.
12 —	33,0	Do. do.	12 —	34,0	Do.
1 P. M.	34,0	Do. do.	1 P. M.	36,0	Very dull, showers of
2 —	34,0	Do. do.	2 —	35,5	snow from the E.
3 —	34,0	Sunshine at intervals.	3 —	35,0	
4 —	34,0	Very dull, not unpleas.	4 —	34,0	Dreadful storm.
5 —	34,0	Do. do.	5 —	34,0	Do.
6 —	34,0	Do. rather disagreeable.	6 —	34,0	Do.
7 —	34,0	Do. do.	7 —	34,0	Do.
8 —	34,0	Do. wind increasing.	8 —	34,0	Do.
9 —	34,0	Do. do.	9 —	34,0	Do.
10 —	34,0	Do. unpleasant.	10 —	34,0	Do.
11 —	33,5	Do. do.	11 —	33,0	Do.
12 —	33,5	Do. do.	12 —	33,0	Do. snow drifting.
RESULTS.			RESULTS.		
1. Average temperature of the 24 hours, - - - 32,27+			1. Average temperature of the 24 hours, - - - 35,3		
2. Maximum (1 p. m.) - 34,00			2. Maximum (8 a. m.) - 38,00		
3. Minimum (6 a. m.) - 28,00			3. Minimum (12 p. m.) - 33,00		
4. Range of observed temp. 6,00			4. Range of observed temp. - 5,00		
5. Mean of the extremes, - 31,00			5. Mean of the extremes, - 35,50		
6. Average rise per hour, - 1,20			6. Average rise per hour, - 1,50		
7. Average fall per hour, - 1,50			7. Average fall per hour, - 1,16		
8. Average temperature of the day occurred at many hours.			8. Average temperature of the day occurred at 11 a. m., 2 p. m.		
NOTE—Sun rose 8 h. 34 min. a. m. set 3 h. 34 min. p. m.			NOTE—Sun rose 7 h. 58 min. a. m. set 4 h. 30 min. p. m.		

MARCH 3. 1823.			APRIL 7. 1823.		
HOUR.	THER.	WEATHER, &c.	HOUR.	THER.	WEATHER, &c.
1 A. M.	43,0	Very dark ; windy.	1 A. M.	40,5	Very dark, not unplea-
2 —	42,5	Do. do.	2 —	41,0	Do. do. [sant.
3 —	42,0	Do. do.	3 —	40,0	Do. do.
4 —	42,0	Do. wind abated.	4 —	41,5	Dull ; cloudy.
5 —	41,5	Dullish, not unpleasant	5 —	40,0	Very splendid dawn.
6 —	40,0	Do.	6 —	40,0	Clear sunshine.
7 —	42,0	Fine ; dim sunshine.	7 —	40,0	Very fine.
8 —	42,0	Dull.	8 —	44,0	Do.
9 —	43,0	Pleasant.	9 —	46,0	Do.
10 —	44,5	Fine sunsh., pleasant.	10 —	46,0	Do.
11 —	45,0	Rather dull.	11 —	50,0	Cloudy, very pleasant.
12 —	45,0	Dullish, fine.	12 —	50,0	Do,
1 P. M.	46,0	Fine.	1 P. M.	52,0	
2 —	50,0	Dullish.	2 —	52,0	Fine sunshine.
3 —	50,0	Do.	3 —	52,0	Do.
4 —	51,0	Do. wind increasing.	4 —	54,0	Do.
5 —	50,0	Do.	5 —	52,0	Do.
6 —	50,0	Str. gale. Bar. 29.07.	6 —	49,5	Do.
7 —	45,0	Do.	7 —	45,0	Very fine, clear, starry.
8 —	42,0	Wind increasing.	8 —	44,0	Do. do.
9 —	39,5	Dull ; no rain.	9 —	43,5	Do. do.
10 —	39,0	Do.	10 —	41,5	Do. do.
11 —	38,0	Blowing a very stiff	11 —	40,5	Do. do.
12 —	38,0	[gale.	12 —	40,0	Do. do.

RESULTS.		RESULTS.	
1. Average temperature of the	24 hours, - 43,79	1. Average temperature of the	24 hours, - 45,18+
2. Maximum (4 p. m.)	- 51,00	2. Maximum (4 p. m.)	- 54,00
3. Minimum (12 p. m.)	- 38,00	3. Minimum (5 a. m.)	- 40,00
4. Range of observed temp.	- 13,00	4. Range of observed temp.	14,00
5. Mean of the extremes,	- 44,50	5. Mean of the extremes,	- 47,00
6. Average rise per hour,	- 1,57	6. Average rise per hour,	- 2,28
7. Average fall per hour,	- 1,50	7. Average fall per hour,	- 1,70
8. Average temperature of the day	occurred at 9 a. m. and 8 p. m.	8. Average temperature of the day	occurred at 8 a. m. and 7 p. m.

NOTE—Sun rose 6 h. 50 min. a. m. set 5 h. 34 min. p. m.	NOTE—Sun rose 5 h. 19 min. a. m. set 6 h. 46 min. p. m.
--	--

MAY 3. 1823.			JUNE 4. 1823.		
HOUR.	THER.	WEATHER, &c.	HOUR.	THER.	WEATHER, &c.
1 A. M.	48,0	Clear, very fine.	1 A. M.	42,5	Fine dawn.
2 —	46,0	Do. do.	2 —	43,0	Do. very beautiful.
3 —	46,0	Do. do.	3 —	44,0	Do.
4 —	45,0	Fine sunshine.	4 —	45,0	Do. bright sunshine.
5 —	44,5	Extremely pleasant.	5 —	46,0	Do. do.
6 —	48,0	Do.	6 —	48,0	Very fine.
7 —	50,0	Do.	7 —	51,0	Do.
8 —	50,0	Do. wind E. gentle.	8 —	52,0	Dullish, pleasant.
9 —	52,0	Do.	9 —	55,0	Do. do.
10 —	53,0	Do.	10 —	56,5	Do. do.
11 —	56,0	Do.	11 —	56,0	Do. do.
12 —	57,0	Very fine uninter-	12 —	59,5	Dull, not unpleasant.
1 P. M.	57,0	[ed sunshine.	1 P. M.	58,5	Do.
2 —	57,0	Do. do.	2 —	60,0	Fine sunshine.
3 —	58,5	Do. do.	3 —	64,5	Do.
4 —	61,0	Do. do.	4 —	62,0	Dullish.
5 —	58,0	Do. do.	5 —	60,0	Sunshine, very fine.
6 —	53,5	Do. do.	6 —	60,0	Do. do.
7 —	51,5	Very fine, clear.	7 —	58,0	Do. do.
8 —	48,0	Do. do.	8 —	54,0	Do. do.
9 —	48,0	Do. no.	9 —	50,0	Clear, fine, few clouds.
10 —	46,0	Do. do.	10 —	48,5	Do. do.
11 —	45,0	Do. do.	11 —	48,0	Do. do.
12 —	45,0	Do. do.	12 —	47,0	Do. do.
RESULTS.			RESULTS.		
1. Average temperature of the 24 hours, -	51,00		1. Average temperature of the 24 hours, -	52,87+	
2. Maximum (4 p. m.)	61,00		2. Maximum (3 p. m.)	64,50	
3. Minimum (5 a. m.)	44,50		3. Minimum (1 a. m.)	42,50	
4. Range of observed temp.	16,50		4. Range of observed temp.	22,00	
5. Mean of the extremes,	52,75		5. Mean of the extremes,	57,50	
6. Average rise per hour,	2,06		6. Average rise per hour,	1,95	
7. Average fall per hour,	2,31		7. Average fall per hour,	1,80	
8. Average temperature of the day occurred at 8 a. m. and 7 p. m.			8. Average temperature of the day occurred at 8 a. m. and 8 p. m.		
NOTE —Sun rose 4 h. 16 min. a. m. set 7 h. 38 min. p. m.			NOTE —Sun rose 3 h. 22 min. a. m. set 8 h. 33 min. p. m.		

The results of the preceding journal I shall now state, confining myself at present to the recording of the simple facts as they appeared on calculation. Dr BREWSTER suggested to me the best mode of drawing the most interesting results, which I followed with all possible care and attention.

Having taken the averages of each twenty-four hours' observations (which were as follows):—

1822, July,	.	.	.	58.31+
August,	.	.	.	56.17+
September,	.	.	.	60.27
October,	.	.	.	52.75
November,	.	.	.	55.64+
December,	.	.	.	40.97+
1823, January,	.	.	.	32.27
February,	.	.	.	35.33+
March,	.	.	.	43.79+
April,	.	.	.	45.18+
May,	.	.	.	51.00
June,	.	.	.	52.87+

and the mean of these, (which proved to be 48°.71+), I calculated the average temperature of each hour in the twenty-four, as it occurred throughout the twelve divisions of the series. This gave

1 A. M. 45.37+	9 A. M. 49.12+	5 P. M. 52.76+
2 — 45.12+	10 — 50.48+	6 — 51.33+
3 — 45.0	11 — 51.54+	7 — 49.75
4 — 44.91+	12 — 52.20+	8 — 48.17—
5 — 44.73	1 P. M. 52.87+	9 — 47.00+
6 — 45.29+	2 — 53.12+	10 — 46.58+
7 — 46.58+	3 — 54.16	11 — 45.67—
8 — 48.17—	4 — 54.67—	12 — 45.07—

The mean of these temperatures, again, is 48°.73+ varying only .02+ from the mean of the whole, obtained by taking the average of the mean temperature of each twenty-four hours' observations. In this manner, I got data for future calculations, the final results of which I shall now state. In doing so, I propose to use the mean

temperature of the whole observations, as derived by the last mentioned plan, for the general standard of comparison.

It was,		48.73+
Mean of the maximum and minimum averages,		49.69+
— — — 1 a. m. and 1 p. m.,	.	49.12
— — — 2 a. m. — 2 p. m.,	.	49.12
— — — 3 a. m. — 3 p. m.,	.	49.58
— — — 4 a. m. — 4 p. m.,	.	49.83+
— — — 5 a. m. — 5 p. m.,	.	48.74+
— — — 6 a. m. — 6 p. m.,	.	48.31
— — — 7 a. m. — 7 p. m.,	.	48.16+
— — — 8 a. m. — 8 p. m.,	.	48.16+
— — — 9 a. m. — 9 p. m.,	.	48.06+
— — — 10 a. m. — 10 p. m.,	.	48.53+
— — — 11 a. m. — 11 p. m.,	.	48.60
— — — 12 noon — 12 midnight,	.	48.63
— — — 7 a. m, 2 p. m. and 9 p. m. *,		48.90+
— — — 8 a. m. 1 p. m. — 6 p. m. †,		50.79+
— — — 7 a. m. 1 p. m. — 10 p. m. ‡,		48.68+
— — 5 a. m. 10 a. m, 3 p. m. and 10 p. m.,		48.74+

Here, then, are many hours which afford a near approximation to the average temperature assumed as the standard of comparison; and many others might be combined to give the same result; but this were needless.

From what has been already recorded, it appears, finally, *First*, That no single hour approaches, more nearly, in its temperature, to the true average temperature of the day, than does eight in the morning, or eight in the evening, (for, according to the preceding calculations, their temperatures seem to be exactly the same). The difference between the true mean of the day, and the temperature at eight o'clock, was about $\frac{5.7}{100}$ of a degree.

* Hours proposed by Dr DEWEY.

† Hours proposed by the Philosophical Society of New-York.

‡ Hours which I myself found to approach nearer, in their mean temperature, than any other three hours, to the average temperature of the day.

Secondly, That the mean of the maxima and minima differs $\frac{9.6}{100}$ from the average of the twenty-four hours. (The mean of the means of the maxima and minima which occurred during the series was $49^{\circ}.28$ varying only $\frac{5.4}{100}$ from the standard of comparison.)

Thirdly, That of the averages of the temperatures of two hours, those of 5 A. M. and 5 P. M. noon and midnight, 11 A. M. and 11 P. M., 10 A. M. and 10 P. M. approach nearest to the mean of the day. The average of 5 and 5, differing from it only $\frac{1.01}{100}$ of a degree; of 12 and 12, $\frac{1}{10}$; of 11 and 11, $\frac{1.5}{100}$; of 10 and 10, $\frac{1}{5}$.

Fourthly, That of the averages of the temperatures of three hours, those of 7 A. M., 1 P. M. and 10 P. M., approximate most closely to the average of the whole twenty-four, the mean of the former differing $\frac{1}{20}$ from the latter.

Fifthly, Of all the combinations of hours I tried, none gave the true mean temperature of the day so well as the mean of 5 A. M. 10 A. M. 3 P. M. and 10 P. M., which corresponded with the average of the day within $\frac{5}{1000}$ of a degree.

Such are the simple facts regarding the most important results to be obtained from this series of observations:—I abstain from farther remarks at present, and shall now conclude by mentioning the other results, less important, derived from the same source.

1. At an average, the maximum of temperature occurred at 4 P. M. and the minimum at 5 A. M.

2. The average daily range was 9.93 , its maximum being 23° , which happened in August. Its minimum 5° in February.

3. The temperatures of 7 A. M. and 10 P. M. were exactly the same.

LEITH, }
July 1823. }

X.—Notice of a “*Journal of a Voyage from Rio de Janeiro to the Coast of Peru, by Mr WILLIAM JAMESON, Surgeon, Corresponding Member of the Wernerian Natural History Society.*”

By G A. WALKER ARNOTT, Esq. A. M. F. R. S. E.
M. W. S., &c.

(Read 26th April 1823.)

“ON the evening,” says Mr JAMESON, “of the 9th March 1822, we re-embarked on board the Fifeshire Packet, having determined to go to sea early the following morning. At 4 o'clock A. M. we accordingly got underweigh, and proceeded down the harbour of Rio de Janeiro. At 7, the land-breeze having failed, and the tide setting against us, we were obliged to anchor abreast of Porto Fogo Bay. At 10, the sea-breeze having, as usual, commenced, we again got underweigh, and cleared the entrance of the harbour, after making several short tacks. Wind ESE. At 4 P. M. passed Round Island. Evening, light variable winds, occasionally calm.”

On the 20th, having reached Lat. $35^{\circ} 23'$, and Long. $51^{\circ} 20'$, Mr JAMESON appears to have commenced observations, which he continued during the voyage, once a day, on the temperature of the sea; and at 10 in the morning, and the same hour in the evening, on that of the air. The hygrometer (LESLIE'S) was not forgot. Of the states of these, a very neat table is given at the close of the Journal.

On the 26th, they “passed many floating bunches of *Fucus giganteus*,” (*Macrocystis pyrifera* of AGARDH'S

Species Algarum); several Albatrosses (*Diomedea exulans*) were also seen. Lat. $39^{\circ} 20'$, Long. $54^{\circ} 13'$.

On the 27th, "Moderate breezes from NE., with clear weather. Passed considerable quantities of *Fucus giganteus**. At 10 A. M. temperature of the air 58° , ocean 52° , hygrometer $15^{\circ}.5$, barometer $28^{\circ}.27$. Evening, strong breeze.

"Here several currents exist; for we frequently observed the sea, within a limited distance, as smooth as a river, with a rippling on the surface. Temperature of the air at 10 P. M. 58° , humidity $8^{\circ}.5$. Lat. by observations at noon $41^{\circ} 10'$ S., Long. by chronometers, $56^{\circ} 17'$ W., and by dead reckoning $56^{\circ} 24'$."

"28th. Strong westerly breeze, with a clear and cloudless sky. The surface of the sea presents the same appearance as yesterday; and, indeed, the existence of a current from the southward is evinced, 1st, By the daily and progressive difference of longitude, as afforded by the daily range and chronometers; 2d, By the sudden diminution in the temperature of the water, being no less than 23° , and, lastly, By the very great quantities of floating *Fucus giganteus*, which vegetates only in high southern latitudes. The influence of the current is not felt beyond the parallel of 40° S., for it is there checked in its progress by the coast of Paraguay extending NW. and SE., as well as by an opposite current flowing from the entrance to the Rio de la Plata. A new impulse is thus communicated, which will occasion the current to take a westerly direction.

"Temperature of the ocean 53° , air 59° , hygrometer $14^{\circ}.5$. A great many moths (*Phalanæ*) were driven on board during the day. Wind WSW., strong. Long. by chronometers $58^{\circ} 20'$, and by dead reckoning $59^{\circ} 7'$; Lat. by

* The terminal part of the frond of this *Fucus* appears to be invariably confluent.

observations at noon $42^{\circ} 45'$ S. Evening clear, occasionally squally. Temperature of the air 55° , humidity $9^{\circ}.5$."

On the 29th, several penguins (*Aptenodytes*) were seen; but Mr JAMESON does not mention what species. Lat. $43^{\circ} 35'$. Long. $58^{\circ} 50'$.

30th. "Temperature of the ocean $48^{\circ}.8$. Still passing quantities of floating *Fucus*. Albatrosses, and three different species of petrels (*Procellariæ*), flying about." Lat. $44^{\circ} 31'$. Long. $59^{\circ} 44'$."

On the 2d April they "passed much *Fucus*," and on the 3d in Lat. $48^{\circ} 50'$, Long. $62^{\circ} 1'$, "sounded in 80 fathoms, fine green sand; saw many whales, and great numbers of oceanic birds, apparently petrels."

On the 5th they were in the parallel, and a little west, of Falkland Islands, and saw many petrels.

6th. A "light air from the NNE., with a clear atmosphere. Sea very smooth, and teeming with vast numbers of a species of cancer (*Asiacus*), of a dark-red colour, and about an inch in length. This remarkable appearance we observed for about an hour, the vessel sailing at the rate of two knots." Lat. $52^{\circ} 25'$. Long. $64^{\circ} 9'$. Mr JAMESON has added on the margin of his journal a sketch of this species of *Cancer*, from which, if correct, it appears to have only six legs: in this respect it differs essentially, not only from the reduced genus *Cancer* of LEACH, but from every division and genus in the order *Macroura* of the subclass *Malacostraca* in the *Annulosa*. All the known divisions of the *Macroura* have at least ten legs: to this order it must, however, certainly be referred, its tail being furnished with appendices at the extremity.

On the 7th, "At 8 A. M., Cape St John, the most easterly point of Staten Island, bore SSE., distant 15'. The northern coast of this island, about New Year's Harbour, is very mountainous, with peaked summits. Although late in the season, no trace of snow could be observed; and indeed, the sides of the mountains exhibited in many places

an appearance of verdure.”—“A strong current appears to set round the east point of Staten Island, the sea being very turbulent and broken.” Several penguins, Cape pigeons, and fulmars, were seen.

On the 13th, Lat. $57^{\circ} 57'$, Long. $64^{\circ} 43'$, he remarks, that “two species of the petrel tribe, *Procellaria glacialis* and *Pr.* , were very common: the former is well known; but the latter is seldom, I believe, seen in the Atlantic Ocean beyond the parallel of 30° S.” We have to regret that the species is not mentioned.

On the 22d, 23d, 24th, 26th, and 28th, they experienced occasional showers of snow: this was betwixt Lat. 58° and 56° . On the 28th a luminous meteor was observed at the mast head, and much lightning in the SW.

May 8th. Lat. $38^{\circ} 24'$, Long. $83^{\circ} 34'$, they were again surrounded by numbers of the oceanic birds (*Procellariæ*).

On the 11th, they passed about 20 miles to the west of the little island of Massafuero, to the north of which they reached about half a degree the next day. Here Mr JAMESON remarks, that “those birds named Cape Pigeons (*Procellaria*) begin to diminish in number.”

On the 16th, Lat. $27^{\circ} 53'$, Long. $75^{\circ} 35'$, they saw some sea-weed, and a few birds, “probably of the genus *Pelecanus*.”

On the 18th, Lat. $24^{\circ} 47'$, Long. $73^{\circ} 36'$, they passed some “floating patches of *Fucus*.” Several small birds (*Procellariæ*), flying-fish (*Exocetus volitans*), and a small species of the cuttle-fish (*Sepia*), were observed.

“20th. Light SE. breeze, and cloudy. This morning we had a nearer view of the coast. Its surface is very irregular, without the least appearance of vegetation. A very high mountain, named Morro de Mexillones, rises to a great elevation. A few altitudes of the sun’s lower limb, with the corresponding times, as indicated by the chronometers, gave for their mean longitude $70^{\circ} 38' 4''$ W., a very near approximation to the true place of the ship.

At 12, Lat. by observation $22^{\circ} 54'$ S. Temperature of the sea $68^{\circ}.5$. At 4 o'clock P. M., being about 12 miles to the NW., the colour of the sea had changed from a dark-blue to a bottle-green. Temperature 65° , a difference of $3^{\circ}.5$, distance from the coast about 20 miles. At 4, altered our course to NE., with the intention of entering the port of Cobijo. At 8 P. M. hove to about three leagues distance from the coast. Evening clear. Temperature of the air at 10 P. M. $66^{\circ}.5$, hygrometer 21° ."

We should remark, in addition to this outline, that Mr JAMESON has added two tables at the end of his journal: one of these, we have already said, is meteorological, containing the state of the thermometer in the air at 10 morning and evening, and the temperature of the sea. This last, he observes in an accompanying letter to Professor JAMESON, was daily ascertained at 12 o'clock, in the usual way, by immersing a thermometer in a bucket of water fresh-drawn. In this table the humidity of the atmosphere is also noted, as observed at 10 morning and evening; "this was determined by two delicate centigrade thermometers, each degree of which is *divided decimally*; and the differences betwixt the dry and humid bulb exposed freely to the air, were daily registered." The state of the weather and the wind, as well as the latitudes and longitudes, are also inserted in this first table.

The second shews the daily differences and rates of three chronometers kept by Mr JAMESON himself on board the packet. In one column are the differences between BROWN's and BARRAUD's chronometers, in another between BROWN's and GRANT's, and in another between BARRAUD's and GRANT's: thus the relative rates of each could be ascertained without great difficulty. Mr JAMESON also gives here the mean temperature of each day, in case that should affect the instruments.

These tables we here insert.

*METEOROLOGICAL JOURNAL from the Mouth of the Rio de la Plata,
to the Coast of Peru.*

Date.	THERMOMETER.				LESLIE'S HYGRO- METER.			LAT. S.	LONG. W	WINDS.
	10 A. M.	10 P. M.	Daily range.	Sea.	10 A. M.	10 P. M.	Daily range.			
1822.										
Mar.										
20	76,5	73,0	3,5	74,0	36,0	35,5	0,5	35° 23'	51° 20'	NE.
21	72,0	68,5	3,5	74,0	28,0	17,0	11,0	35 38	52 32	SSE.
22	81,5	71,0	10,5	74,0	23,9	16,5	7,4	36 18	53 10	WNW.
23	69,0	68,5	0,5	75,0	20,0	17,5	2,5	36 38	53 20	Calm.
24	78,0	69,0	9,0	75,0	36,5	11,5	25,0	37 8	53 20	ENE.
25	70,0	67,5	2,5		17,0	8,0	9,0	38 42	53 57	W.
26	62,0	56,0	6,0		10,0	3,0	7,0	39 20	54 13	NW. very hazy.
27	61,0	58,0	3,0	52,0	15,5	8,5	7,0	41 10	56 17	
28	59,0	55,0	4,0	53,0	14,5	9,5	5,0	42 45	58 20	WNW. clear.
29	52,5	52,5	0,0	52,0	17,0	19,5	2,5	43 35	58 50	WNW. rain.
30	58,0	51,0	7,0	48,8	18,0	5,5	12,5	44 35	60 51	W.
31	54,5	51,0	3,5	49,0	20,5	4,5	16,0	45 21	59 18	NE. cloudy.
Ap. 1	48,7	48,0	0,7	49,0	5,5	5,5	0,0	46 20	61 52	SE. hazy.
2	54,0	54,0	0,0	50,2	5,5	8,5	3,0	47 21	62 25	S. hazy. NNW.
3	53,8	50,5	3,3	49,0	10,0	4,0	6,0	48 50	62 1	S. hazy.
4	55,5	50,0	5,5	48,0	9,0	6,0	3,0	49 57	61 26	NW. b W.
5	49,5	45,0	4,5	47,0	9,0	5,5	3,5	51 8	62 29	ESE.
6	49,7	47,0	2,7	47,0	20,0	8,5	11,5	52 25	64 29	NE.
7	47,0	45,0	2,0	45,5	8,5	5,5	3,0	54 46	63 26	S.
8	44,8	43,0	1,8	39,8	7,0	5,0	2,0	55 44	64 20	W.
9	41,5	40,0	1,5	39,5	7,5	11,0	3,5	56 45	65 45	SW. squally.
10	40,8	40,0	0,8	36,3	3,0	2,0	1,0	56 57	63 10	WSW.
11	43,0	41,0	2,0	37,0	2,0	2,5	0,5	56 59	64 13	WNW.
12	42,0	40,0	2,0	39,5	7,5	10,5	3,0	57 26	64 31	Calm. NW.
13	44,5	42,0	2,5	39,0	9,0	5,5	3,5	57 57	64 43	NW.
14	46,0	43,0	3,0	39,0	11,0	4,5	6,5	58 0	65 41	W. b N.
15	44,0	42,0	2,0	39,0	8,0	3,0	5,0	58 36	67 57	Calm. SE. squal.
16	33,0			41,0	5,5			57 40	71 21	SSE. S. SW.
17	32,0			41,0	4,5			56 24	72 46	S. b W. squally.
18	35,0				6,0			56 21	72 53	WSW.
19	38,0	35,0	3,0		7,0	5,5	1,5	56 28	73 55	N.
20	44,5	40,0	4,5	42,0	5,6	3,0	2,6	56 41	74 57	WNW.
21	39,0							57 2	75 45	West.
22	40,0				6,0			57 54	75 8	WNW.
23	33,0			41,0	4,0			58 52	76 21	WSW.
24	38,0	36,0	2,0	41,0	3,0		3,0	58 21	76 41	Calm. NE. b E.
25	36,0	33,5	2,5		10,0	4,0	6,0	58 0	77 43	W.
26	35,5	33,0	2,5		11,0	5,5	5,5	57 22	79 53	SE. b E.
27	40,5	37,0	3,5		19,0	10,0	9,0	56 19	81 30	W.
28	43,0	41,5	1,5		14,0	12,5	1,5	55 25	80 56	SSW. squally.
29	43,0	42,0	1,0		10,0	9,0	1,0	54 53	81 18	W. b S. squally.
30								54 13	81 23	SW.

Journal continued.

Date.	THERMOMETER.				LESLIE'S HYGRO- METER.			LAT. S.	LONG. W.	WINDS.
	10 A. M.	10 P. M.	Daily range.	Sea.	10 A. M.	10 P. M.	Daily range.			
1822, May										
1	43,0	42,5	1,5	44,7	7,5	6,0	1,5	53° 53'	80° 57'	NW. calm, SE.
2	43,0	44,0	1,0	46,0	19,0	11,0	8,0	51 31	82 30	SE. fresh breeze.
3	46,0	48,0	2,0	48,4	9,5	3,5	6,0	49 15	83 32	SW. cloudy, rain.
4	51,0	52,0	1,0	50,0	6,0	8,5	2,5	46 56	83 55	NW. Ev. WSW.
5	52,0	50,5	1,5	53,0	12,0	4,0	8,0	44 11		S. cloudy.
6	53,0	54,0	1,0	56,0	7,0	16,5	9,5	41 27	83 12	SW. rain, S. clear.
7	56,0	56,0	0,0	59,0	14,0	16,5	2,5	39 43	83 23	SSE. S.
8	57,0	56,0	1,0	60,0	33,0	31,0	2,0	38 34	83 34	WNW.
9	58,0	60,0	2,0	61,0	34,0	33,5	0,5	37 1	83 17	West.
10	63,8	62,5	0,5	63,0	32,0	19,0	13,0	35 11	82 16	NW. b N. clear.
11	63,0	63,0	0,0	65,0	11,0	16,5	5,5	33 16		NW. cloudy.
12	63,0	63,0	0,0	65,0	16,0	15,0	1,0	32 4	78 54	E. clear.
13	63,0	61,5	1,5	64,5	19,0	17,0	2,0	30 42	78 18	E. clear.
14	64,0	61,8	2,2	65,5	29,5	15,0	14,5	29 32	77 18	E. clear sky.
15	63,0	61,0	2,0	63,7	28,5	28,0	0,5	28 22	76 4	ESE. variable.
16	65,8	64,0	1,8	63,7	32,0	27,5	4,5	27 53	75 35	SE. SW. cloudy.
17	64,5	64,0	0,5	64,0	23,5	22,0	1,5	26 53	74 27	ESE. clear.
18	64,0	64,0	0,0	65,0	20,5	16,5	4,0	24 47	73 36	ESE. str. breeze.
19	66,0	64,0	2,0	67,0	26,5	22,0	4,5	23 25	71 23	SE.
20		66,5		68,5		21,0		22 54	70 38	S. SE.

Table shewing the Daily Differences and Rates of three Chronometers kept on board the Fifeshire Packet, in the passage from Rio Janeiro to the Coast of Peru.

1822.	BROWN'S and BARRAUD'S.	Difference.	R.	BROWN'S and GRANT'S.	Difference.	R.	BARRAUD'S and GRANT'S.	Difference.	R.	Thermom. mean.
Mar. 12	4° 26' 15" 3 53 14	" " " 33 1 0	"	4° 31' 30" 4 13 37	" " " 17 53 0	"	4° 7' 45" 4 22 53	" " " 15 8 0	"	
13	8 43 6 8 19 52	33 14 13		8 47 30 8 29 28	18 2 9		8 25 0 8 40 12	15 12 4		
14	3 55 45 3 22 24	33 21 7		3 58 10 3 40 2	18 8 6		3 27 10 3 42 23	15 13 1		
15	3 55 10 3 21 39	33 31 10		3 56 45 3 38 30	18 15 7		3 26 50 3 42 6	15 16 3		
16	4 45 10 4 11 31	33 39 8		4 47 5 4 28 42	18 23 8		4 17 10 4 32 28	15 18 2		
17	5 4 30 4 30 40	33 50 11		5 6 35 4 48 7	18 28 5		4 35 35 4 50 58	15 23 5		
18	4 4 10 3 30 9	34 1 11		4 6 10 3 47 36	18 34 6		3 34 35 3 50 3	15 28 5		
19	4 38 25 4 4 12	34 13 12		4 40 5 4 21 21	18 44 10		4 9 10 4 24 39	15 29 1		
20	4 27 20 3 52 56	34 24 11		4 29 55 4 11 2	18 53 9		3 57 40 4 13 12	15 32 3	74.7	
21	4 44 25 4 9 50	34 35 11		4 46 40 4 27 39	19 1 8		4 14 40 4 30 15	15 35 3	69.7	
22	4 15 10 3 40 24	34 46 11		4 17 20 3 58 11	19 9 8		3 44 40 4 0 18	15 38 3	71.7	
23	4 31 45 3 56 48	34 57 11		4 35 10 4 15 55	19 15 6		4 30 50 4 19 32	15 42 4	68.8	
24	12 38 20 12 3 11	35 9 12		12 40 10 12 20 50	19 20 5		12 7 2 12 22 50	15 48 6	73.5	
25	4 30 15 3 54 58	35 17 8		4 30 45 4 11 18	19 27 7		4 56 20 4 12 0	15 50 2	68.7	

Table of Differences continued.

1822.	BROWN'S and BARAUD'S.	Difference.	R.	BROWN'S and GRANT'S.	Difference.	R.	BARAUD'S and GRANT'S.	Difference.	R.	Thermom. mean.
Mar. 26	4° 30' 5" 3 54 34	' " " 35 31 14		4° 32' 5" 4 12 28	' " " 19 37 10		4° 59' 5" 4 15 01	' " " 15 55 5		59.0
27	5 14 30 4 38 49	' " " 35 41 10		5 16 40 4 56 57	' " " 19 43 6		4 45 10 5 1 9	' " " 15 59 4		59.5
28	4 42 20 4 6 27	' " " 35 53 12		4 45 10 4 25 21	' " " 19 49 6		4 11 35 4 27 39	' " " 16 4 5		57.0
29	4 22 30 3 46 29	' " " 36 1 8		4 24 30 4 4 38	' " " 19 52 3		3 50 15 4 6 25	' " " 16 10 6		52.5
30	4 50 30 4 14 22	' " " 36 8 7		4 55 10 4 35 16	' " " 19 54 2		4 21 50 4 38 5	' " " 16 15 5		54.5
31	4 35 50 3 59 33	' " " 36 17 9		4 37 5 4 17 9	' " " 19 56 2		4 3 30 4 19 53	' " " 16 23 8		52.8
Ap. 1	4 39 40 4 3 15	' " " 36 25 8		4 42 15 4 22 16	' " " 19 59 3		4 8 55 4 25 22	' " " 16 27 4		48.3
2	4 20 20 3 43 43	' " " 36 37 12		4 22 10 4 2 52	' " " 20 5 6		4 47 10 4 3 42	' " " 16 32 5		54.0
3	5 3 45 4 27 0	' " " 36 45 8		5 6 5 4 45 55	' " " 20 10 5		4 30 50 4 47 26	' " " 16 36 4		52.2
4	4 53 10 4 16 15	' " " 36 55 10		4 57 30 4 37 14	' " " 20 16 6		4 21 30 4 38 10	' " " 16 40 4		52.7
5	4 41 50 4 4 45	' " " 37 5 10		4 43 0 4 22 40	' " " 20 20 4		4 7 30 4 24 16	' " " 16 46 6		47.3
6	4 53 10 4 15 57	' " " 37 13 8		4 55 30 4 35 6	' " " 20 24 4		4 20 10 4 36 59	' " " 16 49 3		48.3
7	5 3 15 4 25 55	' " " 37 20 7		5 4 15 4 43 47	' " " 20 28 4		4 29 10 4 46 3	' " " 16 53 4		46.0
8	4 14 00 3 36 29	' " " 37 31 11		4 15 30 3 55 0	' " " 20 30 2		3 39 40 3 56 41	' " " 17 1 8		43.9
9	5 15 25 4 37 45	' " " 37 40 9		4 18 10 4 57 35	' " " 29 35 5		4 42 20 4 59 26	' " " 17 6 5		40.8

Table of Differences continued.

1822.	BROWN'S and BARRAUD'S.			Difference.	R.	BROWN'S and GRANT'S.			Difference.	R.	BARRAUD'S and GRANTS.			Difference.	R.	Therm. Mean.
April	5°	6'	30"	'	"	5°	9'	10"	'	"	4°	34'	45"	'	"	
10	4 28	42	37 48	8	4 48	33	20 37	2	4 47	33	17 12	6	40.4			
11	4 56	40	37 56	8	4 58	35	20 38	1	4 22	40	17 18	6	42.0			
12	5 3	40	38 00	4	5 6	30	20 38	00	4 30	30	17 23	5	41.0			
13	4 39	10	38 6	6	4 41	10	20 36	-2	4 5	10	17 31	8	43.3			
14	5 24	40	30 11	5	5 26	30	20 34	2	4 50	20	17 38	7	44.5			
15	5 4	50	38 18	7	5 6	40	20 34	00	4 30	10	17 45	7	43.0			
16	5 14	10	38 27	9	5 16	30	20 38	+4	4 40	10	17 51	6	33.0			
17	5 18	15	38 33	6	5 20	10	20 39	1	4 44	20	17 54	3	32.0			
18	5 11	10	38 37	4	5 12	20	20 38	-1	4 35	10	17 59	5	35.0			
19	5 7	50	38 42	5	5 8	40	20 38	00	4 30	50	18 3	4	36.5			
20	5 36	10	38 47	5	5 38	40	20 38	00	5 1	20	18 8	5	42.3			
21	5 2	10	38 51	4	5 3	30	20 38	00	4 26	50	18 14	6	39.0			
22	5 8	10	38 58	7	5 9	45	20 38	00	4 32	40	18 20	6	40.0			
23	5 36	30	39 7	9	5 37	45	20 42	+4	5 1	10	18 25	5	33.0			
24	5 20	10	39 14	7	5 22	30	20 42	00	4 45	50	18 32	7	37.0			

Table of Differences continued.

1822.	BROWN'S and BARRAUD'S.	Difference.	R.	BROWN'S and GRANT'S.	Difference.	R.	BARRAUD'S and GRANT'S.	Difference.	R.	Thermom. Mean.
April										
25	5° 29' 10" 4 49 49	" " "	"	5° 31' 30" 5 10 48	" " "	"	4° 56' 40" 5 15 19	" " "	"	"
		39 21	7		20 42	00		18 39	7	34.3
26	5 57 30 5 18 5			5 58 50 5 38 8			5 21 20 5 40 3			
		39 25	4		20 42	00		18 43	4	34.3
27	6 25 50 5 46 18			5 28 40 6 7 57			5 51 10 6 9 58			
		39 32	7		20 43	+1		18 48	5	38.8
28	5 27 15 4 47 37			5 28 10 5 7 27			4 50 10 5 9 6			
		39 38	6		20 43	00		18 56	8	42.2
29	5 22 10 4 42 26			5 21 10 5 3 27			4 48 00 5 7 00			
		39 44	6		20 43	00		19 00	4	42.5
30	4 44 15 4 4 21			4 44 50 4 24 3			4 5 40 4 24 47			
May		39 54	10		20 47	+4		19 7	7	43.3
1	5 16 50 4 36 51			5 19 40 4 58 50			4 42 10 5 1 21			
		39 59	5		20 50	3		19 11	4	43.3
2	5 53 50 5 13 45			5 55 20 5 34 29			5 16 45 5 36 1			
		40 5	6		20 51	1		19 16	5	44.5
3	6 29 40 5 49 29			6 31 40 6 10 48			5 52 50 6 12 10			
		40 11	6		20 52	1		19 20	4	47.0
4	6 1 50 5 21 32			6 2 40 5 41 47			5 23 10 5 42 36			
		40 18	7		20 53	1		19 26	6	51.5
5	6 18 50 5 38 24			6 20 50 5 59 55			5 42 25 6 1 56			
		40 26	8		20 55	2		19 31	5	51.3
6	6 33 10 5 52 36			6 35 30 6 14 31			5 56 35 6 16 11			
		40 34	8		20 59	4		19 36	5	53.5
7	6 27 10 5 46 23			6 29 10 6 8 4			5 49 50 6 9 32			
		40 47	13		21 6	7		19 42	6	56.0
8	6 31 30 5 50 32			6 32 55 6 11 44			5 54 50 6 14 36			
		40 58	11		21 11	5		19 46	4	56.5
9	6 27 10 5 46 2			6 28 50 6 7 33			5 54 10 6 14 2			
		41 8	10		21 17	6		19 52	6	59.0

Table of Differences continued.

1822.	BROWN'S and BARRAUD'S.	Difference.	R.	BROWN'S and GRANT'S.	Difference.	R.	BARRAUD'S and GRANT'S.	Difference.	R.	Thermom. Mean.
May										
10	7° 45' 20"	' "	"	7° 46' 50"			7 7 10	' "		
	7 4 7	41 13	5	7 25 27	21 23	6	7 27 2	19 52	0	62.7
11	2 56 30			2 58 15			2 19 50			
	2 15 6	41 24	11	2 36 49	21 26	3	2 39 48	19 58	6	63.0
12	6 9 10			6 10 40			5 31 10			
	5 27 39	41 31	7	5 49 10	21 30	4	5 51 12	20 2	4	63.0
13	6 5 10			6 6 10			5 25 40			
	5 23 30	41 40	9	5 44 35	21 35	5	5 45 45	20 5	3	61.7
14	6 22 10			6 23 10			5 42 10			
	5 40 18	41 52	12	6 1 28	21 42	7	6 2 20	20 10	5	61.9
15	6 2 10			6 3 25			5 22 10			
	52 0 7	42 31	11	5 41 38	21 47	5	5 42 26	20 16	6	61.5
16	5 56 15			5 56 50			5 15 10			
	5 14 2	42 13	10	5 34 56	21 54	7	5 35 30	20 20	4	64.9
17	6 6 55			6 8 10			5 31 10			
	5 24 33	42 22	9	5 46 13	21 57	3	5 51 36	20 26	6	64.2
18	5 40 20			5 42 50			5 2 10			
	4 57 49	42 31	9	5 20 57	21 59	2	5 22 43	20 33	7	
19										
20	5 39 40			5 42 20			5 0 55			
	4 56 51	42 49		5 20 16	22 4		5 21 41	20 46		

Previous to Mr JAMESON'S quitting Rio Janeiro, he had made one or two botanical excursions, the muscological fruits of which he transmitted to us. He writes, that they are specimens of all that he could collect at Rio de Janeiro. This he, however, adds, was probably owing to his being obliged to limit his walks within a few miles of the capital. It is a district hitherto little examined for the Cryptogamic department of Botany; and, therefore, as might have been anticipated, there are some new species in the packet.

We have to regret, that the imperfect state of some of them renders full descriptions impossible. We have, however, endeavoured to give such as we hope may serve in future to distinguish the plant.

LYCOPODINEÆ.

1. *Lycopodium rupestre*, LIN.

Var. Tenuior, caule ramisque subsimplicibus filiformibus; foliis lanceolato-subulatis, vix apice piliferis.

HAB. *Ad rupes intra portus introitum Rio de Janeiro.*

Forte a *L. rupestri* species distincta, sed fructu non viso separare nequeo.

2. *Lycopodium convolutum*, NOB. Foliis bifariis imbricatis secundis ovatis acutis ciliato-dentatis, superficialibus minoribus geminis, caule erecto distiche, et alternatim ramoso, ramulis dichotome ramosis apicibus convolutis.

HAB. *In subalpinis aridis in Rio Janeiro.*

L. circinali proximum, sed ut supra differt. Fructus non observatus.

MUSCI.

3. *Gymnostomum Jamesoni*, NOB. Foliis late lineari-lanceolatis margine convolutis integerrimis, siccitate incurvo-tortuosis, nervo excurrente, theca turbinata ore amplo, operculo rostrato theca longiore.

HAB. *In collibus in Rio de Janeiro.*

Caulis quatuor ad octo, seta vix ultra duas lineas longa: annulus nullus. *G. tortilis* varietatibus majoribus satis refert, sed foliis, thecæ et operculi figura facile distinguitur.

4. *Dicranum bryoides*, HOOK.

HAB. *Rio de Janeiro.*

Plantæ Europææ omnino similis.

5. *Dicranum flexuosum*, HEDW. Caule subsimplici, foliis erectiusculis rigidis lanceolato-subulatis acuminatis, nervo latissimo, seta subflexuosa, theca ovata striata estrumosa calyptra basi ciliata.

HAB. var. β , *In collibus in Rio de Janeiro.*

Tres varietates hujusce speciei enumero:

α , Caule stricto, foliis lanceolato-subulatis rariter pilosis marginibus subincurvis, e basi vaginante, seta flexuosa. (*Campylopus flexuosus*, *C. pilifer*, et *C. penicellatus*, BRID. Meth., *Dicranum capillaceum*, BRID. Meth., *D. saxicola*, WEB. et MOHR.)

β , Foliis lanceolato-acuminatis pilo cano terminatis e basi vix vaginante, seta incurva.—*a*, caule strictiusculo, (*Dicr. introflexum*, HEDW.)—*b*, caule ascendenti-ramoso (*Polytrichum nigricans*, RICH. *Campylopus Richardi*, BRID. Meth. *Thesanomitrium Richardi*, SCHW. Suppl. tab. 118. haud bene.)

γ , Caule strictissimo simplici, foliis e basi late vaginante subulatis, seta incurva (*Dicr. filiforme*, BEAUV. et SCHW. Suppl. t. 122. *Weissia volcanica*, BRID.)

Omnes hæ varietates setam juniorem plus minusve ma-
dore flexuosam; thecam effœtam plus minus striatam, ad
basin tamen semper rugis acutis prominulisque scabram,
calyptramque fimbriatam dimidiatam habent.

6. *Tortula cirrhata*, NOB. Foliis patentibus lineari lan-
ceolatis margine undulatis, siccitate tortuosis, nervo valido
excurrente, perichæcialibus minoribus, theca cylindracea
erectiuscula, operculo conico-rostrato. (*Trichostomum bar-
bula*, SCHW. Supp. tab. 36. *Trich. barbuloïdes*, BRID. Sp.
Musc. *Tortula lusitanica*, BRID. Sp. Musc.)

HAB. *In collibus in Rio de Janeiro.*

Peristomii dentes leniter torti, et ad basin membrana
brevi connexi; operculum thecæ trientem longitudine æquat.
Folia siccitate tortuosa, nitentia. Caulis 1 ad 9 lineas longa.

7. *Bryum argenteum*, LIN.

HAB. *Ad muros vetustos in Rio de Janeiro.*

8. *Bryum turbinatum*, SCHW.

Var. *minus*, HOOK. in HUMB.

9. *Bryum roseum*, SCHW.

HAB. *In subalpinis aridis in Rio de Janeiro.*

Mnium truncorum et *Domingense*, BRID., vix diversa
suspicor, attamen non mihi visa fateor.

10. *Orthotrichum Jamesoni*, NOB. Caule repente, ramis
erectis, ramosis, foliis ellipticis longitudinaliter plicatis, ner-
vo breviter excurrente, seta longiuscula, theca ovato-oblonga
lævi, calyptra campanulata lævi, basi integra appendicibus-
que latis aucta.

HAB. *Sylvis in Rio de Janeiro.*

O. rugifolio habitu proxime refert, differt tamen foliis
non rugosis aliisque notis. Peristomium exterius e denti-
bus 8 rubris linearibus geminatis fissisve, siccitate revolven-

tibus constat: interius membranaceo-lacerum, Calyptra basi non fissa, sed laciniis latis aucta, hæque laciniæ statu juniore calyptram intus sursum duplicatæ sunt. Folia madore patenti-recurva, siccitate spiraliter quasi in funem torquata; perichætialia longiora. Theca junior inferne quadrisulcata, superne lævissima, brunnea*. Genus *Schlotheimia* vix stabilitum est: potius cum cæteris, Orthotrichi sectio secundo caule repente insignita constitui debet.

11. *Neckera undulata*, HEDW.

HAB. *In arborum truncis in Rio de Janeiro.*

Calyptra mihi mitriformis atque pilosa videtur: ciliæ etiam, non e membrana interna, sed e dentium lateribus progrediuntur; hæc species itaque ad *Daltoniam* HOOKERI, vel *Cryphæam* MOHRI pertinet.

12. *Hookeria tomentosa*.

HAB. *In sylvis in Rio de Janeiro.*

Hookeria vera est calyptra mitriformi: thecæ autem et operculi figura ab *Hookeriarum* omnium aliarum longe diversa. Hæc species eadem est ac *Hypnum tomentosum*, HEDW. Huic generi referenda est *H. tamarisci* vel *rotulata*, eadem enim est species.

13. *Hookeria albicans*, HOOK.

HAB. *In sylvis circa Rio de Janeiro.*

14. *Hookeria affinis*, NOB. Caule procumbente ramoso subcompresso, foliis undique imbricatis, oblongis acuminatis, nervis duobus divergentibus ante apicem evanescentibus, emarginatis integerrimis, theca recta horizontali, oper-

* Duæ alteræ species *O. rugifolium* et *Swainsoni*, "prope Rio Janeiro." crescentes jamdudum ab ill. HOOKERO descriptæ sunt.

culo conico rostrato, seta lævi, calyptra glabra basi multifida.

HAB. *In sylvis circa Rio de Janeiro.*

Hæc species plerasque *Hookerias* simulat; a *H. depressa* operculo longiore, calyptra basi multifida, et, an sit bona HEDWIGII tabula, cellularum magnitudine, differt: a *H. scabriseta* seta lævi; et a *H. pendula* calyptra lævi.

15. *Hookeria prælonga*, NOB. Caule reptante pinnatim ramoso, ramis simplicibus laxè foliosis, foliis distichis subrotundis acuminatis integerrimis, enervibus.

Caulis longus repens; foliorum textura laxa ut in HOOKERIIS, sed fructus non visa.

16. *Hypnum loxense*, HOOK.

HAB. *Rio de Janeiro.*

Ad specimina Humboldtiana exacte congruens, quanquam ex "sylvis Cinchonæ, regione temperata, juxta Loxam et Gonzonanam, alt. 1080 hexap." allata.

17. *Hypnum imbricatum*, SCHW.

HAB. *In sylvis umbrosis in Rio de Janeiro, ad arborum truncos ramulosque, et ad rupes.*

Fructus non adest. Forte ab hac specie non differt *H. hexastichum*, SCHW.

18. *Hypnum minutulum*, HEDW.

19. *Hypnum subsecundum*, NOB. Caule repente subpinnato brevi inferne nudiusculo, foliis sursum patentibus, ovatis acuminulatis concavis, margine recurvis, integerrimis, enervibus, theca erecta ovata, operculo hemisphærico-rostrato.

HAB. *In sylvis in Rio de Janeiro.*

H. crassiusculo habitu et magnitudine proximum; dif-

fert foliis late ovatis, valde concavis, operculo non subulato, theca erecta æquali. Folia sursum solummodo spectant, certe autem non ad tribum foliis falcatis seu secundis designitam pertinet, omnes enim hæ species folia deorsum spectantia habent. Thecam vix maturam possideo, sed de genere non dubito; peristomii dentes externi sordide lutei, interni lutescentes. Folia ratione plantæ magna, reticuli areolis ut in plurimis *Pterogonii* speciebus. Forte mera varietas *H. crassiusculi* in quo etiam foliorum margines subrecurvas video.

20. *Hypnum amœnum*, HEDW.

HAB. *Ad arborum truncos in Rio de Janeiro.*

Ab hac specie non differt *H. recurvans* ex America boreali, nec video quomodo distinguitur a *H. cupressiformi* variabili thecæ forma insigni.

21. *Fontinalis squamosa*, LIN. var.

HAB. *Rio de Janeiro.*

Vix duabus unciis longior: fortasse in locis aqua in æstate deficiente crescit, itaque robusta. Folia crassa canaliculata margine versus apicem involuta.

HEPATICÆ.

22. *Jungermannia patula*.

HAB. *In sylvis in Rio de Janeiro.*

Folia solummodo apice dentata: igiturque ab hac specie removeri debet *Carpolepidum dichotomum*, BEAUV.; habet enim folia non solum apice dentata, sed tota margine ciliato-serrata, secundum exemplaria in herbario Belvisiano conservata: ad *J. adianthoidem* itaque allocanda; sed, ut bene dixit WEBERUS, "num *J. patula* satis a *J. adianthoide*, foliis vix, nisi apice, dentatis differat, peritioribus est diju-

dicandum." Habitus eadem, et nisi discrimina levia supra notata, nihil plane interest.

23. *Jungermannia brachciata?* Sw.

HAB. *In collibus prope Lima*, unde inter muscos ex Rio de Janeiro misit JAMESONUS.

J. filiformi valde similis: differt tamen foliis apice rariter denticulatis, stipulisque foliis multo minoribus. *J. brachiatam* vix cognosco; exemplaria Swartziana dicta ab amicis recepta descriptionem Swartzianam certe non quadrant, folia enim obtusa integerrima, et stipula oblonga videntur.

24. *Jungermannia Tamarisci?* Hook. Caule procumbente ramoso, foliis inæqualiter lobatis, lobis superioribus ovatis concavis integerrimis; inferioribus linearibus vel clavatis integerrimis, stipulis subrotundis apice ætate bifidis.

HAB. *Ad arborum truncos in Rio de Janeiro.*

Caules stricti, ramosi ramulis subcurvatis: folia arefactione retro circa caulem convoluta. Sub nomine *Hypni?* recepi, sed potius *Anictangium ciliatum* var. *filiforme* primo intuitu refert.

Fructus non visus.

25. *Jungermannia platyphylla*, LIN. Var. tenuior.

26. *Jungermannia multifida*, LIN.

HAB. *Rio de Janeiro.*

Huc certe allocari debent *J. palmata* et *bipinnata*. Sw.

XI.—*Inquiry into the Origin and Characteristic Differences of the Native Races inhabiting the Extra-tropical Part of Southern Africa.*

By ROBERT KNOX, M. D.

Member of the Wernerian Natural History Society, and of the Medico-Chirurgical Society of Edinburgh.

(*Read 19th April 1823.*)

THE best apology I can offer for attempting the Inquiry I have now the honour to lay before the Society, is, that no similar one, relative to the country I speak of, has ever been instituted. Many travellers have described, with a minuteness proportioned to their talent for observation, the Peninsula of Southern Africa, and have given to the world valuable works on its natural history, political relations, &c.; but, so far as I know, none has ever viewed the savage races inhabiting this Peninsula in an anatomical point of view, and hence have arisen ill-founded conjectures, and positive errors, too numerous to be criticised. I have endeavoured to correct those more immediately connected with our inquiry, but have carefully avoided general criticism, as leading me from the subject. The Society will

readily imagine the difficulties I experienced in avoiding frequent conjecture, and the impossibility of doing so altogether; but recourse has been had to conjecture rarely, and, though some of the conclusions may, from insufficient data, or other causes, prove erroneous, I shall still feel sufficiently recompensed for my labour, should the facts I have collected be found serviceable to those engaged in writing the Natural History of Man.

The part of Africa situated to the south of the Tropic, contains at least three distinct races of men. Those met with in proceeding from Cape Point northerly, are intruders; they constitute the Anglo-Dutch colony of the Cape, and are a mixture of almost all the modern nations of Europe, the Dutch preponderating. The colonists dwelling in the remoter districts attain a gigantic size, owing, no doubt, to their descent from a race naturally tall; and in perfecting which, as to stature, much has been effected by climate, food, and other localities. This race, at present, extends from Cape Point northward to the banks of the Gariep, or Orange River, and eastward as far as the Keiskamma River. They have pushed before them, and partly exterminated, the race of Hottentots, or Bosjeman (for I shall consider them as the same), who are now found only in small numbers, either as servants to the colonists, or still preserving a sort of savage independence in that vast tract of almost desert country, extending from the chain of mountains out of which the Gariep and Great Kei rivers rise, westward to the shores of the Southern Atlantic. On the verge of the Tropic, and close to the western shore, the Damaras are found (a Negro race, as I have been assured), who extend towards Benguela and Congo; so that the Bosjeman race, if they exist much to the north of the Gariep River, must occupy a central stripe of Africa,

bounded, on one hand, by the Damara and Benguela countries, and, on the other, by the Kaffer nations.

These latter extend from the Keiskamma eastward along the coast towards Inhambane; but previous to reaching this point, they become inland, and possess the mountain-country, which, there is every reason to suppose, may extend from the sources of the Gariep and Great Kei rivers, to the Equator. It would appear from the Journal of VAN REENEN, that the Temboo is the last of the Kaffre tribes found on the coast of Natal, and that beyond them, in about Lat. 26° S., are found the Hamboonas, a race totally different from the Kaffres. They are thus described: "Ce peuple a la peau jaunatre avec de longs cheveux fort epais et frisés, qui sont relevés sur le sommet de la tête en forme de turban *." At the point of coast where the Hamboonas disappear, the Negro race commences, and, extending around Sofala, Inhambane, and Mozambique, furnish the Portuguese with the most ample means of carrying on a traffic the most revolting to the feelings of mankind. The mountain-country, inhabited by the Kaffre race, cannot be of any great breadth, limited as it is on the east by the Negro country of Mozambique, and to the west by the vast and unknown deserts supposed to be inhabited by the wandering Macasses. It is unfortunate for our present inquiry, that two geographical problems of much interest remain to be solved. The Kaffre races have been conjectured to be Arabian, and the Bosjeman tribes have been considered by some of Chinese origin, by others

* I consider the Hamboonas (if they really exist) as descended from a race of shipwrecked Chinese or Malay mariners, modified by intermarriage with Negro or Kaffre tribes. It is, however, quite possible that they may be a race from Madagascar.

of Egyptian; they have even been compared to the Troglodytes or Pygmies of HERODOTUS, that dwelt in the deserts to the south of Barca and Syrene. We shall presently see that the Kaffres are not Bedouin Arabs, and, moreover, that they cannot be traced to any European or Caucasian stock; but the question of origin, as regarding the Bosjeman, is of far more difficult solution. It were highly desirable, as well for geographical science as for the natural history of Man, that the extent of country occupied by the Kaffre race, from the Keiskamma northwards and eastwards,—in other words, the boundaries of Kaffraria Proper, —were correctly ascertained. We know that the race extends on either side the mountain-country stretching from the sources of the Gariep towards the Equator, inhabiting the valleys and slopes of the mountains: their progress westward was probably arrested by the existence of great central deserts, and by their natural dislike to such countries; whilst eastward, that is, towards the Indian Ocean, numerous Negro tribes were in possession of the country. That they have long been an inland race, is evident from their total ignorance of the use of boats or canoes: moreover, the Portuguese, in their ardent search after gold, received some severe checks from the black races inhabiting the mountains to the westward of their settlements: now, it is probable that these were Kaffre tribes, for Negroes are naturally timid, and easily subdued.

It is much more difficult to guess with any shew of probability at the extent of the Bosjeman nations, partly from their total dissimilarity to all surrounding tribes, and partly from the extremely defective state of our knowledge relative to the geography of Central Africa. It is well known that they originally extended to Cape Point, and have been found to the northward as far as Europeans have yet penetrated. Beyond this all is profound obscurity: How, then,

are the aborigines of Southern Africa to be traced to the primitive races of the ancient world? In the absence of all historical detail relative to the affiliation of these races, and until some future Park shall make us acquainted with Central Africa, as well to the south as to the north of the Line, both being equally unknown, we shall bring together the results presented by anatomical inquiry, which, being a method founded on fixed and general physical laws, will, if it attain not the truth, at least approximate to it.

We may view the human race as derived originally from one stock, to which the arbitrary name of Caucasian has been given. This species, influenced by climate and civilization, assumed, at a very early period, five distinct forms, which have also been arbitrarily designated by the names of Caucasian, Mongolic, Ethiopian, American, and Malay*. We cannot hesitate referring the Kaffre nations to the Ethiopian, not so much from their position, as from their close resemblance; whilst the Bosjeman may be arranged, for the present, with the Mongolic, until further investigation shall have shewn a more intimate relation with some unknown African tribes, or until the race shall have been fairly traced through Central Africa to the Valley of the

* I shall here take the liberty of remarking, that the Malay race seems to me an artificial variety, and has no existence in nature as a distinct race of men. I am inclined to refer the whole inhabitants of the innumerable islands scattered over the Great South Sea (including New Holland) to the American variety. In Southern India they have mixed with the Mongolic and Caucasian races, and form consequently a mixed or mulatto breed; but they may be traced tolerably pure as high as Sumatra, in which island several tribes are found much resembling the native Americans, and retaining all their customs, even to the pretended flattening of the head by artificial means. It is probable that in this race only are found the anthropophagous tribes.



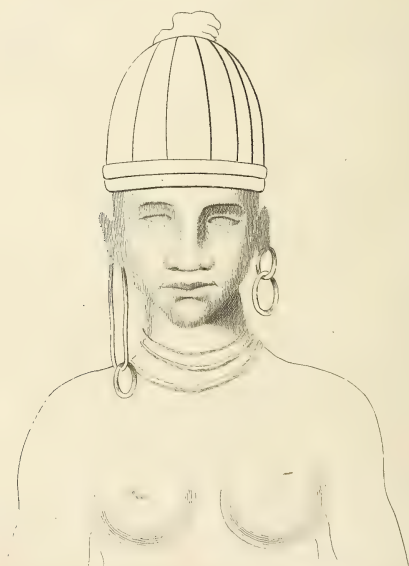

Female figure sculptured in the Cave of Elephantina in India supposed by D^r Ancorville to have been formed about 210 years prior to the present era

Nile; and thence to Asia, where we suppose all nations to have originated.

Var. ETHIOP.

NEGRO.	KAFFRE, including Temboo, Briquas, Boshuanas, Red Kaffres, &c. &c.
Colour generally very dark.	Of a brown colour; some perfectly black.
Hair black, and, as it is called, woolly.	Hair uniformly black, crisp, and woolly, and scattered in small tufts over the scalp.
Head narrow, compressed on the sides.	Cranium narrow, elongated, resembling in outline the female European*.
Forehead arched.	Forehead differing but little from the Negro, that is, rather retreating; very narrow, and not high.
Malar bones prominent; eyes full.	As in the Negro.
Nose thick, and little distinct from the lips.	In the greater number nearly as in the Negro; some have less of the Ethiopian physiognomy.
Upper jaws elongated forwards.	The osseous development of the upper jaw nearly as great as in the Negro.
The superior incisors obliquely projecting.	Hardly the case in the Kaffre.
Excessive fulness of the lips.	Nearly as in the Negro.
Retreating chin.	Not so much so as in the Negro.
Many bandy-legged. A certain difficulty in maintaining the upright position; the knees slightly bent, and the heels constantly tending to quit the ground. The gastrocnemii muscles placed too near the ham.	Never the case in the Kaffre. His lower extremities are finely proportioned, and frequently of Herculean strength; the upper extremities weak and disproportioned; whilst the lower limbs, pelvis, and loins, are superior even to the European.

* Compare the accompanying sketch of the Kaffre cranium (Plate VII.) drawn from one in my possession, with a cranium of the Caucasian variety.

The cranium of the Kaffre is inferior in most of its measurements to the European. The temporal bones are flat and compressed, and the squamous suture often straight, instead of being semicircular, as in the European *. They are nice in the choice of their food, and reject fish, fowls, and generally whatever by the Levitical law is deemed unclean; yet they eat the inner parts of animals, as the intestines, stomach, lungs, &c. raw, torn from the animal just dead.

From a careful consideration of the habits and configuration of this race, I believe them to be closely allied to the Negro, and that the observable differences are attributable to the different climates they inhabit. The Kaffres, in a word, are the Negroes of the mountains; they are Negroes changed by inhabiting an extra-tropical climate; like all mountaineers, they are hardy, bold, and fond of liberty. In intellect they are superior to the Negro, and I believe them capable of a very considerable degree of civilization. The remarkable disproportion observable between the upper and lower extremities of the Kaffre † may, perhaps, be owing to the very unequal degree of exertion to which these separate parts of the body are exposed. The Kaffre never labours, and hence his arms are weak; but he is strongly exercised in the chase and in predatory excursions, by which means his limbs become muscular, and occasion-

* Some Kaffre skulls have been shewn me, in which the malar bones were remarkably large, and the face very broad; but this is not the usual Kaffre physiognomy. Such anomalies exist amongst all nations and races, but cannot be supposed sufficient to refute the general position, that each race has a form of cranium and face peculiar to itself.

† Of twenty-two ivory armlets, taken indiscriminately from the arms of Kaffres, four only were found which could admit the arm of a moderately muscular European.

ally altogether Herculean. The excess of nutrition gives rise, no doubt, to the enormously swelled legs to which many of them are liable, when, through indolence, or the infirmities of age, they are disinclined to continue the same life of activity. Circumcision and polygamy they practise with almost all African nations.

According to the relations of modern and ancient travellers, tribes similar to the Kaffre race are found scattered over Africa, apparently unconnected with each other. We are told of a nation of Negroes, called Nubæ, inhabiting the country to the west of the Nile, near the confluence of the Abyssinian and true Nile: they are described as being mild in character, and of small features, though the nose be flat, and the hair woolly: they speak a soft sonorous language, differing in these points from their neighbours. Travellers describe the Ababdes, living to the east of the Nile, as being Blacks, with European features. But as few travellers have been anatomists, their accounts cannot altogether be depended on.

A very general belief prevails, that, by external means, and more particularly by pressure, the human cranium and form generally may be modified, and permanently altered, and that this may at last become hereditary. It is asserted, for example, that the more remarkable craniological differences amongst nations are occasioned by external pressure; that the flatness of the African nose arises from the same cause; that Negroes are bandy-legged, because they are carried during infancy on their nurses' back; and that the large feet of the Kaffre, and the small ones of the Bosjeman, are owing to an abundant supply of food to the former, and a deficient one to the latter*. All such asser-

* BLUMENBACH de Nat. Variet.

tions are constantly refuted by an appeal to facts. The feet and hands of the Kaffre and Bosjeman are strictly and beautifully proportional: though they be carried during infancy in the same manner as the Negro, they are never bandy-legged or deformed. The African nose is flat, independent of any mechanical skill exercised by the nurse; and human crania are fashioned all over the world by the hands of Nature, and not by man.

Var. MONGOL.

True MONGOL inhabiting the deserts of Central Asia.	AFRICAN BOSJEMAN, including the numerous Hottentot tribes, as Namaquas, &c. &c.
Colour yellow, or of an olive tinge.	Colour light yellow, or olive; it is difficult to describe, and varies in intensity amongst the Hottentots; but is pretty uniform amongst the true Bosjeman.
Hair black, coarse, straight, and scarce.	Hair black, usually short, though sometimes growing to a considerable length, and is scattered over the scalp in detached tufts, as in the Kaffre.
Head of a square form.	General outline of the head much resembles the Mongol, that is, broad and square.
Face broad, flat, depressed, the features being therefore, as it were, confluent.	Face having a considerable resemblance to the true Mongol; the lips are full.
Forehead smooth and flat.	As in the Mongol.
Nose small and flat.	
Aperture of the eye-lids narrow and linear.	As in the Mongol. The angle at the internal canthus of the eye is quite rounded away.
Chin somewhat projecting.	Chin very small and pointed, but not projecting.

In addition to these characters of the races, I may remark, that in the Bosjeman there is the finest symmetry of the whole frame: their stature is remarkably diminutive; I should conjecture the average to be about 4 feet 6 inches in the male population. The females have remarkably prominent nates and elongated nymphæ; both these peculiarities are removed by a single cross with the Kaffre or European. The Bosjeman have uncommon powers of vision; this also is lost by intermarriage with another race. The cranium is finely formed, and thin; the nasal processes of the superior maxillary bones large and broad: these give to the Mongol and Bosjeman the appearance of breadth at the root of the nose. The foramina for the transmission of the hypoglossal nerves, are very large*. The cranium, viewed vertically, is nearly equal to the well-formed European head. The parietal bones bulge out very much, and the cranium is at this point broadest. It agrees with the Mongol in having the occipital foramen larger than in the other races. The floor of the orbit does not encroach so much on the cavity as in the Mongol; this affects the physiognomy to a considerable extent, in so far as regards the direction of the eyes.

The habits of the Bosjeman race have been described by most African travellers with sufficient accuracy, and I shall therefore limit my remarks to a few points of resemblance between the true Mongol and Bosjeman races. This consists, first, in the countries they inhabit, which, in either case, are vast elevated sandy deserts, nearly destitute of herbage and water: secondly, in the partiality both races

* These foramina are decidedly larger in the Black than in the White races, but more particularly in the Negro. They clearly indicate the passage of a proportionally large nerve.

have for horse-flesh as an article of diet, preferring it to every other sort of food; they strictly merit the appellation of *Hippophagi*: lastly, in the acuteness of their vision, which almost exceeds belief. I have found their sight to be equal to that of most Europeans when aided by excellent hand-telescopes of the best construction. The Bosjeman is ingenious, clever, and neat-handed; his powers of mimicry are great, his understanding good. He readily acquires languages, and his speed of foot is almost proverbial.

The origin of the race, by which I mean the mode of their descent, and separation from one or other of the more extended varieties of the human race, is one of the most interesting inquiries which the natural history of Man presents. To connect the Bosjeman with the Mongolin variety, we must step at once from the Peninsula of Southern Africa, to the great central deserts of Asia; the intermediate links are lost,—the intervening races unknown. History, though not altogether to be depended on in the consideration of events so remote, must not in the present instance be despised. Though surcharged and disfigured with fable, there is one fact to which such constant allusion is made, as almost to put it beyond a doubt,—I allude to the frequent descents of the northern Asiatic races on the southern states of Europe and Asia. The valuable monuments of antiquity, still preserved in the Cave of Elephantina, in Peninsular India, attest the predominating presence of the Mongol race, at a period removed from the birth of our Saviour by more than 2000 years*, and that, at that time,

* Compare the annexed drawing (Plate VII.) of the female figure sculptured in the Cave of Elephantina, and copied from the "*Recherches sur l'Origine des Arts*," with the beautiful and expressive portraits of the Bosjeman and Hottentot races by Mr DANIELLS in his "*African Scenery*."

the Mongol physiognomy bore the strongest resemblance to the present Chinese and Bosjeman races. The early introduction of the Mongol or Northern Asiatic races into Peninsular India is further attested by their influence on the modern Hindoo; for though the excellent BLUMENBACH assures us that the Hindoo cranium is quite equal in beauty and proportions to that of the Turk, and consequently refers the race to the Caucasian variety, yet, in the Hindoo heads I have examined, the development of the upper jaw has not been strictly Caucasian*.

The vast antiquity of the Mongol hordes of Asia is further proved by the early establishment of the Chinese empire; and though I am fully persuaded of the still greater antiquity of those of Hindostan and of Egypt, yet many passages in HERODOTUS point out that the Mongolic tribes, with a rapidity even exceeding the Caucasian, rapidly assumed the form of great and warlike nations.

It would seem, then, from a hasty examination of historic records, of the remains of antiquity, and of the laws and religious ceremonies transmitted from generation to generation, that at a very early period the Mongol races penetrated into Europe † and southern Asia; and there is nothing improbable in the supposition, that they may have

* The inspection of a fine collection of skulls, collected on the Banks of the Ganges, and which, through the kindness of PROFESSOR JAMESON, I was enabled to examine immediately on their arrival, has confirmed me in this opinion. In these skulls, which, with the exception of one Negro head, seem all to be of the Caucasian race, the cranium is quite equal to any European, and its longitudinal diameter shorter than in most: but there is a development and strength in the upper maxillary bone which, I should think, will not be found to exist in any Turkish, Syriac, or Jewish head.

† The peculiar Mongol face is very strongly marked in many families now inhabiting the Highlands of Scotland, and more particularly the Hebrides.

modified by their presence some of the races of central Africa.

Lest it might seem an omission that I have not described the Mongol race as having penetrated into the wilds of America, I shall here state, that the few Esquimaux crania examined by me, have proved to be strictly American, nor have I ever seen the slightest approach to the Mongol head in any native American race. I have only further to observe, that most of the opinions offered in this memoir are founded not on theory or conjecture, but on an anatomical examination of the crania of numerous races of men. For the opportunity of doing so, I am in a great measure indebted to Professor JAMESON, and to Doctors MONRO and BARCLAY, through whose politeness I was allowed to examine whatever specimens their valuable museums contained. I beg leave to offer my thanks to these gentlemen.

The annexed table gives a comparative view of the measurements of the head in several remarkable varieties of the human race.

EDINBURGH, }
March 1. 1822. }

	Inches.	Inches.	Inches.	Inches.	Inches.	Inches.	Inches.	Inches.	Inches.	Inches.
Carib.				3.5						
Turk.				3.5						
Negress.			2.6							
Male European.			2.9							
Male Kaffre.			2.8							
Hottentot Venus, (from a cast).			2.7							
European Fe- male.			2.8							
Cranium sup- posed to be Ma- laic.			3							
New Hollander.			2.5							
Cranium sup- posed to be from New Holland.			3							
Hottentot.			2.3							
Length of the face from the root of the nose to the edge of the alveo- lar process,			3.7							
From the anterior portion of the fo- ramen occipitale to the incisive teeth of the upper jaw,			3.6							
Breadth at the temples *,			19.7							
Whole circumference,			5.2							
Greatest breadth †,			1.3 by 1.5							
Foramen occipitale ‡,			1.3 by 1.5							
Length over the vertex, that is, from the ossa nasi to the posterior edge of the occipital foramen,			14.1							
Measurement from mastoid to mas- toid over the vertex,			13							

* Not to be depended on.

† Varies very much; broadest, however, generally over or near the temporal bones; sometimes, as in most of the black races, in the middle of the parietal bones.

‡ Generally speaking, the foramen occipitale is largest in the Mongul, and smallest in the Negro. I have seen it very large in the Esquimaux, but am not sure that this is constant.

XII.—*A Monograph of the Genus Pyrola.*

By Mr DAVID DON, Librarian of the Linnean Society,
M. W. S.

(*Read 21st April 1821.*)

WHEN we contemplate the great increase of new species which Botany is daily acquiring, Monographs are rendered indispensably necessary to the exact knowledge of the species which compose particular genera, and more especially of such whose species are nearly related to each other. The genus *Pyrola*, although far from being numerous in species, has nevertheless been hitherto involved in much confusion. I have corrected the synonymes, and endeavoured to improve the specific characters of the older species; but, considering the great difficulty which attends such a task, I fear, in the latter point, I have not in many instances been successful. For the new or rare species contained in the following pages, I am indebted to the kindness of Mr LAMBERT, and Mr BROWN. The last distinguished botanist, who is now in possession of the Banksian Herbarium, has with great liberality permitted me to ex-

amine the several new species contained in that splendid collection.

The genus *Pyrola* belongs to the natural order *Ericææ*, as now constituted, comprizing the *Ericæ* and *Rhododendra* of JUSSIEU, and to the section of true *Ericææ*, from which it would be unnatural to exclude the *Vaccineæ* of M. DE CANDOLLE. The *Monotropeæ*, another section of *Ericææ*, first proposed by Mr NUTTALL, in his Genera of North American Plants, consist of *Monotropa* and *Hypopithys* (which ought to be again united to *Monotropa*, being not sufficiently distinct from it), and his new genus *Pterospora*. These in many respects approach near to *Pyrola*, both in habit and characters, and especially as there is a leafless species of *Pyrola*; but the manner of emitting their pollen is totally different, not being by pores, but by lateral fissures. The anthers of *Monotropa* are not, as Mr NUTTALL has supposed, unilocular, although, after shedding their pollen, and from the peculiar mode of emitting it, they appear to be so: they are flat and circular, furnished with two very short obtuse horns at their base, and emit their pollen by two transverse fissures on their internal surface. Those of *Pterospora*, on the contrary, shed their pollen by longitudinal fissures, and have two very long subulate horns at their base. This plant appears to be the link between these two sections.

The whole genus being perfectly natural, I have preferred retaining it entire. I have separated the whole into two divisions, and these I have again subdivided into sections. The first division contains the largest portion of the species, consisting of those the valves of whose capsules begin first to open at the base, with their margins connected with an intricate fine tomentum, with alternate leaves, and

flowers disposed in racemes. The second division consists of such as have the valves of their capsule beginning to open first at the top, and their margins unconnected by any kind of tomentum; with verticillate leaves; flowers solitary, or corymbose. This division contains only four species, subdivided into two sections. To the first section belongs *P. uniflora*; and to the second belong *P. umbellata*, *maculata*, and a new species *P. Menziesii*. These three last constitute the genus *Chimaphila* of PURSH, the *Chimaza* of Mr BROWN. I have, however, preferred considering them as a section rather than a distinct genus. They differ chiefly from the other species by their stipitate filaments, by the valves of their capsule opening first at the top, with their margins destitute of the connecting tomentum, and the lobes of the receptacle being bipartite: these two last characters they have in common with *P. uniflora*. The style, which, in *P. umbellata*, is immersed in the germen, is very short in *maculata*, so as to be just distinguished from it; but, in *P. Menziesii*, which is very nearly related to the last, it is perfectly distinct from the germen. Their general habit has been much insisted on as a just reason for their separation; but this difference in habit is not near so striking in them as in *P. uniflora* and *aphylla*, and yet the flowers of the latter are so like those of the *rotundifolia*, that unless for a slight difference in the laciniae of the calyx, they might readily be confounded.

The species of this genus are extensively diffused through the northern Hemisphere. In the Temperate Zones they are chiefly met with in mountainous situations, some of the species, such as *P. uniflora* and *secunda*, extending to considerable elevations: in the Frigid Zones, on the contrary, they are only to be found in the lowest and narrowest plains adjacent to the sea, and are never met with in these regions

beyond the limit of trees. Most of the species extend across the Continents of Asia, Europe, and America. There are specimens of *secunda* and *uniflora* in the Banksian Herbarium, from the islands on the north-west coast of America: The *P. picta* of SMITH is found on the north-west coast of America, and in mountainous situations in Japan. Some species, however, are of more limited diffusion: thus, *P. asarifolia*, *maculata*, and *elliptica*, have only been found in North America. The *P. dentata*, *Menziesii*, and *occidentalis*, are still more confined, being only found in particular districts.

Their favourite places of growth are woods, especially old pine and birch forests, and bushy places, and mountainous heaths, in a dry light soil, particularly that formed from decayed vegetables, mixed with a great proportion of siliceous earth.

All the *Pyrolæ* are possessed of a strong astringent quality, and were formerly much esteemed for supposed healing properties: they are now wholly disused. The *P. maculata*, however, is deserving of the attention of physicians, and is held in great esteem among the Indians of North America, who call it, according to Mr PURSH, *Sip-tiserwa*. This botanist tells us, that he has witnessed the beneficial effects of a decoction of this plant, in a very severe case of hysterics; and I am credibly informed its decoction has proved very serviceable in scrofulous diseases.

—

PYROLA, *Tournef. Linn. Juss.*

CHIMAPHILA, *Pursh*; CHIMAZA, *Brown.*

Linn. Syst. DECANDRIA MONOGYNIA.

Nat. Ord. ERICEÆ. § 1. *Ericææ veræ.*

CHAR. ESSENT. *Calyx* 5-partitus. *Petala* 5. *Antheræ* basi foraminibus 2 hiantes. *Stigma* 5-lobum. *Capsula* 5-ocularis. *Placentæ* lunatæ. *Semina* angustè scobiformia, utrinque alata. *Embryo* transversus.

Character prolatus Generis.

Calyx parvus, 5-partitus, persistens. *Petala* 5, hypogyna, imbricatim conniventia, caduca. *Stamina* 10: *filamenta* subulata, hypogyna, rarò (in *Chimaphilá*) stipitata: *antheræ* 2-loculares, foraminibus 2, sæpiùs tubulatis, ad basin hiantes, postmodò inversæ. *Pistillum* 1: *ovarium* globosum: *stylus* simplex, sæpiùs elongatus, nunc rarò vix ullus: *stigma* 5-lobum. *Capsula* globosa, 5-ocularis, 5-valvis, medio loculorum singulorum 5-fariam dehiscens: *valvis* margine tomento tenuissimo sæpiùs intricatè connexis. *Placentæ* 5, lunatæ, spongiosæ, simplices v. bipartitæ, axi centrali 5-angulo insertæ. *Dissepimenta* axis centralis angulis adnata. *Semina* numerosissima, minuta, angustè scobiformia, basi apiceque alata, funiculo umbilicali per medium placentis adnata: *testa* simplex, reticulata, membranacea, laxa, fuscescens: *albumen* carnosum, subrotundum, album. *Embryo* transversus, minutus, niveus, in albuminis extremitate umbilicali: *cotyledones* breves, crassæ, obtusæ: *radicula* brevissima, crassa, obtusa, umbilicum spectante.

Hab. veget. — Herbæ vel suffrutices, sempervirentes, humiles, radicibus latè repentibus. Folia petiolata, alterna,

terna, vel rariùs verticillata, glabra, sæpiùs nitida, coriacea, crenulata, dentata aut serrata. Scapi erecti, squamis paucis sparsis instructi, sæpiùs triquetri vel 4-anguli, convoluti. Flores pedicellati, bracteati, penduli, globosi vel campanulati, s. rarò patuli, albi aut rosei, in racemis sive corymbis terminalibus dispositi, rarò (in P. uniflorâ) solitarii.

CONSPECTUS SPECIERUM.

DIVISIO I.—*Capsulæ valvarum marginibus, tomento tenuissimo intricatè connexis, à basi deliscentibus. Foliis alternis. Floribus racemosis.*

SECT. 1.—*Stamina adscendentia. Stylus declinatus, petalis longior. Stigma annulatum.*

Scapi erecti. Flores campanulati, racemosi, penduli, undiquè versi, v. rariùs subsecundi.

1. *P. rotundifolia*, foliis subrotundis integerrimis crenulatisve coriaceis petiolo dilatato brevioribus, scapo triquetro, laciniis calycinis lanceolatis acutis, stigmatè clavato obtusè 5-dentato.

2. *P. asarifolia*, foliis reniformibus coriaceis repando-crenatis petiolo dilatato duplò brevioribus, scapo acutè triquetro, racemo multifloro, laciniis calycinis ovatis acuminatis appressis, stigmatè clavato: disco elongato 5-dentato.

3. *P. chlorantha*, foliis orbiculatis retusis obsoletè crenulatis petiolo angusto duplò brevioribus, racemo paucifloro, laciniis calycinis brevissimis obtusis, petalis oblongis, foraminibus antherarum tubulosis, stigmatè clavato: disco elongato 5-lobo.

4. *P. occidentalis*, foliis subrotundis membranaceis obsolete denticulatis petiolo simplici duplò longioribus, racemò paucifloro, laciniis calycinis oblongis obtusis, stigmatis disco 5-lobo.

5. *P. elliptica*, foliis ellipticis ovatisve membranaceis serrulatis petiolo dilatato longioribus, racemò paucifloro, bracteis lanceolato-subulatis apice recurvis, laciniis calycinis brevissimis: mucronulo recurvo, petalis ovalibus, stigmate clavato: disco elongato 5-lobo.

6. *P. dentata*, foliis cuneato-oblongis coriaceis basi acutis margine remotè dentatis integerrimisve petiolo angusto duplò longioribus, racemò elongato multifloro subsecundo, petalis ovalibus, stigmatis disco elongato 5-lobo.

7. *P. picta*, foliis ovalibus mucronulatis coriaceis subseratis petiolo angusto æquantibus subtùs rubris suprà fasciis pallidis, racemò plurifloro undiquè verso, petalis subrotundis, stigmate clavato: disco 5-lobo.

8. *P. aphylla*, aphylla; scapo angulato basi crebrè squamoso, racemò multifloro subsecundo, laciniis calycinis ovatis acutis crenulatis, petalis subrotundis, stigmatis disco elongato 5-crenato.

SECT. 2.—*Stamina* erecta, versus pistillum inflexa. *Stylus* decurvus, petalis longior. *Stigma* exannulatum.

Scapi erecti. Flores *racemosi, globosi, penduli, undiquè versi*.

9. *P. media*, foliis orbiculatis subrotundo-ovalibusve crenulatis coriaceis petiolo dilatato æquantibus, scapo acutè triquetro spirali, racemò multifloro, laciniis calycinis ovatis acutis, stylo decurvo, stigmate capitato obtusè 5-lobo.

SECT. 3.—*Stamina* erecta. *Stylus* rectus. *Stigma* exanulatum.

Scapi erecti. Flores penduli, racemosi.

10. *P. minor*, foliis subrotundis ovalibusve coriaceis repando-crenulatis petiolo dilatato longioribus, racemo spicato, bracteis pedicellis multò longioribus, laciniis calycinis brevissimis, stylo incluso, stigmate planiusculo 5-lobo.

11. *P. secunda*, foliis ovatis acutis membranaceis argutè serratis petiolo angusto longioribus, racemo unilaterali, laciniis calycinis rotundatis, petalis oblongis, stylo exserto, stigmate planiusculo 5-lobo.

DIVISIO II.—*Capsulæ valvarum, marginibus tomento destitutis, ab apice dehiscentibus. Foliis ternis verticillatisve. Floribus solitariis, corymbosis umbellatisve.*

SECT. 1.—*Petala* patentia. *Stamina* patentia, per paria approximata, petalis opposita. *Pistillum* rectum.

Folia terna. Scapi uniflori.

12. *P. uniflora*, flore solitario, antherarum foraminibus elongato-tubulosis, stigmate acutè 5-dentato, foliis orbiculatis serratis.

SECT. 2.—*Chimaphila* (*Chimaza*, BROWN). *Petala* reflexo-patula. *Filamenta* stipitata: *stipitibus* in membranam circinatam supernè dilatatis. *Antherarum foraminibus* elongatis, tubulosis. *Stylus* brevissimus aut ovario immersus. *Stigma* latè orbiculatum: *disco* 5-fisso.

Suffrutices. Folia terna vel quaterna, sive pluria verticillata. Flores corymbosi.

13. *P. umbellata*, foliis cuneato-lanceolatis serratis quaternis senisve, pedunculo pubescente corymbifero, bracteolis lineari-subulatis, appendicibus filamentorum ciliatis, stylo immerso.

14. *P. maculata*, foliis lanceolatis acuminatis inciso-serratis discoloribus oppositis ternisve, pedunculo pubescente corymbifero, bracteolis linearibus, appendicibus filamentorum lanatis, stylo brevissimo.

15. *P. Menziesii*, foliis alternis ternisve lanceolatis acuminatis serratis discoloribus, pedunculo glabro bifloro, bracteolis latè rotundatis, laciniis calycinis ellipticis acutis, stylo distincto.

HISTORIA SPECIERUM.

DIVISIO PRIMA.

SECT. I.

1. *P. rotundifolia*, foliis subrotundis integerrimis crenulatisve petiolo dilatato brevioribus, scapo triquetro, laciniis calycinis lanceolatis acutis, stigmatè clavato obtusè 5-dentato.

P. rotundifolia, Linn. Sp. Plant. 567. — Pall. it. 3. p. 287. — Poll. pal. n. 395. — Georgii Fl. baikal. p. 214. — Fl. Kamtsch. in Arct. Zool. p. 195. — Retz. Obs. 1. p. 17. — Hoffm. germ. 143. — Krocker Siles. 2. p. 12. — Roth. germ. 1. 181. 11. 462. — Willd. Sp. Pl. 2. p. 621. (exclus. synonym. Fl. Dan. et Blackw. t. 594.) — Smith, brit. 2. p. 444. (exclus. synonym. Fl. Dan. et Raii Synop.) — Eng. Bot. t. 213. — Lam. Encycl. 5. p. 741. — Illust. t. 367. fig. 1. (mala). — Mich. Amer. 1. p. 251. — Persoon, Syn. 1. 483. — Wahlenb. lappon. 110. ejusd. Fl. Carpath. 114. — Pursh, Amer. Sept. 1. p. 299. — De Cand. Syn. Fl. Gall. 249.

- P. grandiflora*, Rad. Diss. p. 27, t. 3, f. 2.
P. staminibus adscendentibus, pistillo declinato, Linn. Suec. 330.—Mat. Med. 212.—Amœn. Acad. 1. p. 156.—Gmel. Sib. 4. p. 128. n. 15.
P. staminibus et pistillis declinatis, Fl. Lapp. 169.
P. foliis subrotundis, tubis recurvis, Hall. Helv. n. 1010.
P. foliis integerrimis, Vir. cliff. 37.—Roy. lugdb. 440.
P. foliis subrotundis, scapo racemoso, Hort. Cliff. 162.
P. rotundifolia major, Bauh. pin. 191. Hist. 3. p. 2. 535.
 Pyrola, Ger. em. 408.—Camer. Epit. 723.
P. folio rotundo, Riv. t. 137. (benè), et t. 136. fig. 2. (optima).
P. vulgator, Clus. Hist. 2. 116.—Moris. sect. 12. t. 10. f. 1.
 Limonium, Fuchs. Hist. 467.
 Limonium sylvestre, Frag. Hist. 707.

Round-leaved Wintergreen.

Habitat in dumetis ac sylvis antiquissimis montosis Asiæ, Europæ, et Americæ Borealis. 4. (v. v. c. et s. sp.)

Radix latè repens. *Folia* pluria, alterna, erecta, subrotunda vel subrotundo-ovalia, obtusissima, coriacea, integerrima s. remotè crenulata, glabra, lucida. *Petiola* dilatati, 2–3 pollices longi, margine membranacei, paginâ foliorum sæpiùs duplò longiores. *Scapi* solitarii, palmares v. spithamei, s. rariùs ultrà, erecti haud convoluti, triquetri, squamis 2–3 lanceolatis acutis muniti. *Racemus* erectus, elongatus, 10–16-florus. *Pedicelli* subremoti, recurvati, undiquè versi. *Bracteæ* ovato-lanceolatæ, mucronatæ, scariosæ, fuscæ, pedicellis longiores. *Flores* campanulati, majusculi, lactei. *Calycis lacinia* lanceolatæ, acutæ, petalis paulò breviores. *Petala* orbiculata, subcarnosa. *Stamina* adscendentia, petalis breviora: *filamenta* glabra, albo-virescentia, basi latè dilatata: *antheræ* flavæ, foraminibus sessilibus aperientes. *Pistillum* petalis duplò longius; *stylus* declinatus, incrassatus, recurvus: *stigma* supernè assurgens, annulatum: *disco* convexo, subrotato, obtusè 5-dentato.

The present species is much the largest of the whole genus. The leaves are round, or roundish-oval, coriaceous, entire, or crenulated; the petioles are flat, and dilated often

twice the length of the leaves. The scape is triquetrous, never convolute. The raceme is erect, elongated, 12 to 16 flowered; flowers distant, cernuous, white, without any tinge of red, larger than those of *P. media*, emitting a fragrant smell, particularly in serene warm weather. The *P. rotundifolia* has very frequently been confounded with the *media* of SWARTZ, which is much the most common, at least in Great Britain. The figures of *Flora Danica*, and BLACKWELL, and the synonym of RAY, and perhaps also those of HUDSON and WITHERING, belong to *P. media*. The *P. rotundifolia* is certainly not found in the places enumerated by the two last-mentioned authors, but only *P. media* and *minor*. It differs from *media* by its longer stamens, which are directed to the upper part of the corolla; its style being twice longer, declined, with a thickened recurved apex; the stigma being annulate, with a 5-toothed disk; the laciniae of the calyx being lanceolate; the petals being white, without any tinge of red. The scape is never convolute, as in *media*. The leaves often scarcely exceed in length the half of the petioles. In the figure in English Botany, the flowers are erroneously made to spread too much, and the petals acute; the petioles also are quite too short.

2. *P. asarifolia*, foliis reniformibus coriaceis repandocrenatis petiolo dilatato duplò brevioribus, scapo acutè triquetro, racemo multifloro, laciniis calycinis ovatis acumina-tis appressis, stigmatè clavato: disco elongato 5-lobo.

P. asarifolia, Mich. Amer. 1. p. 251.—Lam. Encycl. 5. p. 743.—Per-
soon, Synop. 1. 483.—Pursh, Amer. Sept. 1. p. 299.

Asarum-leaved Wintergreen.

Habitat in pinetis Canadæ (MICHAMX, PURSH), in sylvis fagorum montosis Pennsylvaniae. PURSH. 7. (v. s. in Herb. Lamb.)

Radix repens. *Folia* pluria, sæpiùs reniformia, coriacea, glabra, lucida, repando-crenata. *Petiolì* 2-3-unciales, dilatati, margine membranacei, paginâ foliorum duplò longiores. *Scapi* palmares, acutè triquetri v. spithamei, squamis paucis scariosis convolutis instructi. *Racemus* elongatus, multiflorus. *Pedicelli* remoti, undiquè versi. *Bracteæ* lanceolatæ, acuminatæ, pedicellorum longitudine. *Flores* globosi, cernui, albo-virentes, magnitudine *P. rotundifoliæ*. *Calycis laciniæ* ovatæ, acutæ, appressæ. *Petala* orbiculata. *Stamina* adscendentia, petala æquantia: *filamenta* glabra, alba, basi dilatata: *antheræ* flavæ, basi vix fissæ: *foraminibus* sessilibus. *Pistillum* staminibus duplò longius: *stylus* declinatus: apice adscendens, clavatus, annulâ cinctus. *Stigmatis discum* elongatum 5-dentatum.

The leaves of this species appear to me to be subject to some slight variations; but in the true state they are of a reniform shape, nearly about the size and form of those of *Asarum europæum*: this remarkable character, if constant, would alone have been sufficient to distinguish it from every other species. The plant itself, is about the size of *P. rotundifolia*, which it greatly resembles in the figure and disposition of its flowers, which are of a greenish-white colour. The above description is taken from very fine specimens, collected in Upper Canada by the late Mr PURSH, author of the Flora of North America, during his travels in 1815. It is but justice to his memory, as a botanist, to state, that, if he had lived, he intended to publish a Flora of Canada, for which he had collected ample materials: these are now in the possession of A. B. LAMBERT, Esq. Mr NUTTALL, in his little work, has erroneously confounded it with the following species,

3. *P. chlorantha*, foliis orbiculatis retusis obsoletè crenu-

latis petiolo angusto duplò brevioribus, racemo paucifloro, laciniis calycinis brevissimis obtusis, petalis oblongis, foraminibus antherarum tubulosis, stigmatè clavato: disco elongato 5-lobò.

P. chlorantha, Swartz, Stock. Trans. 1810. p. 190. t. 5.—Nutt. Gen. Amer. 1. p. 273.—Bart. Fl. Phil. p. 202.

P. convoluta, Bart, Prod. Fl. Phil. p. 50.

P. asarifolia, Rad. Diss. p. 23. t. 4. f. 1. (exclus. synonym. Mich.)

P. rotundifolia, β nummularia, Muhl. bat.

P. minor, Pursh, MSS. et fortè Fl. Amer. Sept. 1. p. 299.

Small-leaved Wintergreen.

Habitat in Sueciâ (SWARTZ), in Canadâ Superiore, PURSH.
4. (v. s. in Herb. Pursh. nunc in Mus. Lamb.)

Radix repens. *Folia* patentia, subcoriacea, orbiculata, sæpè omnium minima, glabra, lucida, margine obsolete crenulata, apice retusa. *Petioli* angustè lineares, paginâ foliorum duplò longiores. *Scapi* stricti, palmares, tetragoni, nudi, totum modò squamâ minutâ solitariâ medio instructi. *Racemus* brevis, 5-6-florus. *Pedicelli* decurvati, bracteis lanceolatis acutis longiores, undiquè versi. *Flores* campanulati, magnitudine *P. ellipticæ*, albo-virentes, penduli. *Calycis dentibus* brevissimis, semi-ovatis, obtusis, appressis. *Petala* oblongo-ovalia, staminibus longiora. *Stamina* adscendentia: *filamentis* glabris, basi dilatatis: *antheris* basi bilobis, foraminibus elongatis tubulosis aperientes. *Pistillum* staminibus duplò longius: *stylus* declinatus, adscendens, supernè incrassatus: *stigma* annulatum, disco elongatum, 5-lobum.

4. *P. occidentalis*, foliis subrotundis membranaceis obsolete denticulatis petiolo simplici duplò longioribus, racemo paucifloro, laciniis calycinis oblongis obtusis, stigmatè disco 5-lobò.

P. occidentalis, Brown in Herb. Banks.

Habitat in oræ occidentalis Americæ borealis Insulâ Sledge dictâ. NELSON 4. (v. s. in Herb. Banks.)

Radix repens. *Folia* numerosa, subrotunda, membranacea, obsolete denticulata, reticulatim venosa, duplò minora quàm *P. minore*, utrinque viridia. *Petioli* sesquipollicem longi, paginam foliorum duplò excedentes. *Scapus* erectus, gracilis, filiformis, 5-pollicaris, triqueter. *Racemus* 3—5-florus. *Pedicelli* decurvati, bracteam ovato-oblongam acutam æquantem. *Flores* globosi, penduli, lactei, magnitudine *P. rotundifoliæ*. *Calycis laciniæ* oblongæ, obtusæ, petalis ferè duplò breviores. *Petala* orbiculata, reticulatim venosa, staminibus longiora. *Stamina* erectiuscula: *filamenta* gracilia: *antheræ* breves, foraminibus sessilibus hiantes. *Pistillum* petalis multò longius: *stylus* declinatus, apice incurvus: *stigma* annulatum: *disco* brevi, 5-lobo.

The above species has been determined, and named by Mr BROWN, in the Banksian Herbarium; from excellent specimens collected in Sledge Island, on the north-west coast of America, by Mr DAVID NELSON, an industrious botanist, who accompanied Captain COOK in his third voyage, and who has enriched the Banksian Herbarium with numerous specimens of new plants, collected by him in those regions. It resembles *P. minor* in general habit, but is much smaller, and possesses characters widely different. It cannot be confounded with *P. chlorantha*. The long tubular pores of the antheræ of the latter, with its oblong petals, and very short laciniæ of its calyx, as well as its coriaceous orbicular retuse leaves, and other enumerated distinctive marks, abundantly separate it.

5. *P. elliptica*, foliis ellipticis ovatisve membranaceis serrulatis petiolo dilatato longioribus, racemo paucifloro, bracteis lanceolato-subulatis apice recurvis, laciniis calycinis

brevissimis: mucronulo recurvo, petalis ovalibus, stigmatè clavato: disco elongato 5-lobo.

P. elliptica, Nuttall, Pl. Amer. bor. 1. p. 273.—Rad. Diss. p. 81. t. 5. f. 1.
P. ovalifolia, Pursh, MSS.

Oval-leaved Wintergreen.

Habitat in Americæ Septentrion. sylvis, nempè in Philadelphîâ et Novâ Sarniâ (NUTTALL), in Canadiâ utraque PURSH, 4. (v. s. in Herb. Lamb.)

Radix prorepens. *Folia* patentia, oblongo-ovalia, obtusa aut rariùs ovata, mucronulata, membranacea, tenuiter serrulata, glabra, lucida, basi attenuata. *Petioli* unciales, aut sæpiùs ultra, paginâ foliorum multò breviores, margine membranaceo-dilatati. *Scapus* erectus, gracilis, acutè triqueter, 5-pollicaris, nudus, nunquam convolutus, squamâ 1 scariosâ juxta basin instructus. *Racemus* 5-6-florus. *Bracteæ* lanceolato-subulatæ, pedicellis breviores, apice recurvatæ. *Pedicelli* decurvi, undique versi, distantes. *Flores* campanulati, minores *P. rotundifoliâ*, albi, odorem gratum spirantes. *Calycis laciniæ* brevissimæ, semi-ovatæ, mucronulatæ: *mucronulo* recurvo. *Petala* ovalia, stamina subæquantia. *Stamina* adscendentia: *filamenta* glabra, basi latè dilatata: *antheræ* flavæ, basi vix fissæ: *foraminibus* sessilibus. *Pistillum* staminibus duplò longius: *stylus* declinato-adscendens, supernè incrassatus: *stigma* clavatum annulâ cinctum, disco elongatum 5-lobum.

The present species is much smaller than *P. rotundifolia*. The leaves are membranaceous, finely serrulated, oblong-oval, sometimes ovate, with an attenuated base, much longer than the petioles. Scape very slender, generally about 5 or 6 inches high. Raceme few-flowered. Laciniæ of the calyx very short, semi-ovate; apices of them, as well as of the bracteæ, mucronulate, recurved. Petals oval, equal to the

stamens in length, which are all directed to the upper part of the corolla. Anthers yellow, opening at the base by two sessile pores. Style declined, apex ascending, double the length of the stamens. Stigma clavate, annulate; with an elevated 5-lobed disk.

6. *P. dentata*, foliis cuneato-oblongis coriaceis basi acutis margine remotè dentatis integerrimisve petiolo angusto duplò longioribus, racemo elongato multifloro subsecundo, petalis ovalibus, stigmatis disco elongato 5-lobo.

P. dentata, Smith in Rees' Encycl. ~~XX~~ ~~12~~ ~~222~~

Cuneiform-leaved Wintergreen.

Habitat in Insulâ oræ occidentalis Americæ Borealis, Nootka dictâ. MENZIES. 4. (v. s. in Herb. Banks.)

Radix repens. *Folia* conferta, erecta, oblongo-cuneata, coriacea, glabra, nitida, basi acuta utrinque viridia: *margi-nibus* remotè dentatis integerrimisve. *Petioli* angustè lineares, paginâ foliorum duplò terve breviores. *Scapi* erecti, palmares pedalesve, angulosi, nudi. *Racemus* elongatus, 12-16-florus, secundus, apice cernuus. *Pedicelli* decurvati, bracteas ovato-lanceolatas acutas superantes. *Flores* campanulati, cernui, lactei. *Calycis laciniæ* breves, ovatæ, acutiusculæ. *Petala* latè ovalia. *Stamina* petalis longiora, adscendentia: *filamenta* plana, basi dilatata: *antheræ* lutæ, foraminibus sessilibus urceolatis aperientes. *Pistillum* staminibus longius: *stylus* declinatus, apice incurvus: *stigma* annulatum, disco elongatum, 5-lobum.

This species varies both with entire and dentated leaves. The figure of its leaves alone is sufficient to distinguish it from every other species of the section.

7. *P. picta*, foliis ovalibus mucronulatis coriaceis subser-ratis petiolo angusto æqualibus subtùs rubris suprâ fas-

ciis pallidis, racemo plurifloro undique verso, petalis subrotundis, stigmatè clavato: disco 5-lobo.

P. picta, Smith in Rees' Encycl. ~~vol. 11. p. 212.~~

Two-coloured-leaved Wintergreen.

Habitat in Insulâ oræ occidentalis Americæ Septentrionalis, Nootka dictâ (MENZIES), in montosis Japoniæ, prope urbem Nagasacki. 4. (v. s. in Herb. Banks. et Lamb.)

Radix repens. *Folia* ovalia, coriacea, mucronulata, subserrata, glabra, subtùs rubra, suprâ intensè viridia, ad venas fasciâ pallidâ notata. *Petioli* angusti, sesqui v. biunciales, paginam foliorum subæquantes. *Scapus* erectus, palmaris, acutè triqueter, rubicundus, nunquam convolutus, squamis scariosis munitus. *Racemus* pluriflorus. *Pedicelli* recurvi, undique versi, bracteis lanceolatis acutis breviores; *inferioribus* remotis. *Flores* globosi, campanulati, penduli, albi. *Calycis laciniæ* ovatæ, acutæ, appressæ. *Petala* subrotunda, concava, carnosâ. *Stamina* adscendentia, petalis breviora: *filamenta* alba, glabra, basi latè dilatata: *antheræ* flavæ, basi parùm fissæ, foraminibus sessilibus dilatatis hiantes. *Pistillum* staminibus duplò longius: *stylus* declinato-adscendens, supernè crassior: *stigma* clavatum, annulatum: *disco* vix elongato, 5-lobo.

It differs from the preceding, with which it has considerable resemblance; by the form of its leaves, which are oval, mucronulate, red underneath, dark-green on the upper surface, and marked along the veins with whitish bands, as in *P. maculata*; those of the preceding are oblong, cuneiform, toothed towards the apex, or quite entire, green on both sides. The petioles are much longer, equal, and sometimes exceeding the length of the pagina or dilated portion of the leaf. The scape is acutely triquetrous, mostly about a span high. The raceme is fewer flowered. The pedicels are

shorter than the bractææ. The teeth of the calyx are longer and more acute. The petals broader, and shorter.

The specimens of this species, in the Banksian Herbarium, are from Nootka Island, on the north-west coast of America, where they were collected, along with several other new species, in VANCOUVER'S Voyage, by my kind friend A. MENZIES, Esq., an acute and industrious botanist. Those in the Lambertian Herbarium are from Japan, and were taken in a Dutch prize, whose cargo was sold in London: these appear to me not to differ in any material points from those in the Banksian Herbarium.

8. *P. aphylla*, aphylla; scapo angulato basi crebrè squamoso, racemo multifloro subsecundo, laciniis calycinis ovatis acutis crenulatis, petalis subrotundis, stigmatis disco elongato 5-crenato.

P. aphylla, Smith in Rees' Encycl. ~~xxix~~ 177

Leafless Wintergreen.

Habitat in Insulâ oræ occidentalis Americæ Borealis, Nootka dictâ. MENZIES. γ . (v. s. in Herb. Banks.)

Radix repens; supernè divisâ. *Scapi* plures, crassiusculi, palmares s. ultra, erecti, glabri, angulati. *Folia* nulla, nisi *squamæ* numerosæ, foliaceæ, alternæ, lanceolatae, acutæ, virides, coriaceæ, integerrimæ; *aliæ* scariosæ, per scapum remotè sparsæ. *Racemus* 8-12-florus, subsecundus. *Pedicelli* decurvati bracteas ovato-lanceolatas acuminatas subæquantes. *Flores* globosi, penduli, lactei. *Calycis laciniæ* ovatae, acutæ, crenulatae. *Petala* subrotunda. *Stamina* adscendentia, petalis multò longiora: *filamenta* plana, basi dilatata: *antheræ* oblongæ, flavæ, foraminibus dilatatis brevè tubulosis aperientes. *Pistillum* staminibus longius: *stylus* declinato-adscendens: *stigma* annulatum, disco elongatum, 5-lobum.

This remarkable species, although wholly destitute of real leaves, is not, strictly speaking, leafless; their place is supplied by a kind of foliaceous scales, of a greenish colour, coriaceous, lanceolate, acute, entire. In some of the fine specimens preserved in the Banksian Herbarium, an approach to leaves may be distinctly observed. This circumstance appears to me to confirm the opinion entertained by some botanists respecting the nature of the scales on the scapes of *Monotropa*, *Orobanche*, *Orchides*, &c. considering them as analogous to leaves, or, more properly, abortive ones.

SECT. 2.

9. *P. media*, foliis orbiculatis subrotundo-ovalibusve crenulatis coriaceis petiolo dilatato æquantibus, scapo acutè triquetro spirali, racemo multifloro, laciniis calycinis ovatis acutis, stylo decurvo, stigmatè capitato obtusè 5-lobo.

P. media, Swartz in Act. Holm. 1804, p. 257. t. 7.—Engl. Bot. t. 1945. (bona).—Smith, Comp. Fl. Brit. 65.—Rad. Diss, p. 21. t. 3.

P. rotundifolia, Fl. Dan.t. 110.—Blackw, t. 594.—Huds. Angl. p. 175.—Lightf. Scot. 1. p. 218.—With. Brit. 1. p. 400.

Pyrola, Raii Synop. 363.

Pyrola folio obtuso, Riv. t. 138. (bona).

Intermediate Wintergreen.

Habitat in dumetis et sylvis Sueciæ, et Angliæ borealis; necnon in ericetis, sylvis et dumetis præsertim montosis Scotiæ copiosissimè. ♀. (v. v. sp.)

Radix latè repens. *Folia* numerosa, patentia, orbiculata vel subrotundo-ovalia, plana, crenulata, coriacea, glabra, nitida. *Petioli* plani, dilatati, paginam foliorum æquantés. *Scapus* erectus, acutè triqueter, spiralitè convolutus præsertim versus apicem, sæpiùs palmaris. *Racemus* brevis, densus, 12—16 florus. *Pedicelli* decurvati, undique versi,

bracteis lanceolatis acutis longiores. *Flores* globosi, penduli, albi, roseo tincti, multò majores *P. minore*. *Calycis laciniæ* ovatæ, acutæ. *Petala* lata, orbiculata. *Stamina* erecta, versus pistillum semper inflexa, petalis breviora: *filamenta* subulata, basi non dilatata: *antheræ* ovatæ, flavæ, foraminibus sessilibus dilatatis hiantes. *Pistillum* petalis longius: *stylus* decurvus nunquam adscendens: *stigma* capitatum, obtusè 5-lobum, disco depressum.

This plant, which the older botanists, and some of our modern writers, confounded sometimes with *minor*, sometimes with *rotundifolia*, was first ascertained by the accurate SWARTZ, who has given an excellent description and figure of it in the Stockholm Transactions for 1804. Notwithstanding the length of time since, and the accurate description and figure there given, very few botanical writers have adopted it since that period. This is the more remarkable, as no species can be more distinct. It differs from *rotundifolia* by its shorter style, which is curved downwards, not declined and ascending as in *rotundifolia*, of an equal thickness. The stigma is exannulate, capitate, 5-lobed, depressed in the centre. The stamens are erect, shorter than the petals, and regularly inflected towards the style. The petals are white, tinged with pink. The laciniæ of the calyx are ovate, acute. The flowers are globose, in a much closer and shorter raceme. The scape is acutely triquetrous, and spirally twisted. The petioles seldom exceed the length of the leaf.

SECT. 3.

10. *P. minor*, foliis subrotundis ovalibusve coriaceis repando-crenulatis petiolo dilatato longioribus, racemo spicato bracteis pedicellis multò longioribus, laciniis calycinis brevissimis, stylo incluso, stigmatè planiusculo 5-lobo.

- P. minor*, Linn. Sp. Plant. 567.—Gort. Ingr. 65.—Georgii Fl. Baik. p. 214.—Scop. Carn. 484.—Poll. Pal. 396.—Fl. Dan. t. 55. (fig. med.)—Kniph. Cent. 2. 82.—Hoffm. Germ. 143.—Mat. Sil. 1. 293.—Krocker. Siles. 2. p. 13.—Roth. Germ. I. 181. II. 463.—Willd. Sp. Pl. 2. p. 621.—With. Britt. 401.—Smith, Brit. 2. p. 444.—Engl. Bot. t. 158. (pessima.)—Huds. Angl. 176.—Lam. Encycl. 5. p. 742.—Retz Obs. 1. p. 17.—Lam. Fl. Franc. 2. p. 530.—Persoon Synop. I. 483.—Marsch. a Bieb. Fl. Taur. Cauc. I. p. 312.—Wahl. Lapon. p. 110. ejusd. Fl. Carpath. p. 115.—Rad, Diss. p. 15. t. 1.
- P. rosea*, Engl. Bot. 2543. (bona), Smith.—Comp. Fl. Brit. 65.—Rad. Diss. p. 18. t. 2.
- P. rotundifolia*, Pall. Ind. Taur.
- P. floribus racemosis dispersis, staminibus pistillisque rectis*, Linn. Fl. Gotl. 206. Suec. 331.—Gmel. Sib. 4. p. 128. n. 16. t. 56. f. 1.
- P. foliis subrotundis, scapo undique racemoso, genitalibus rectis*, Aet. Stockh. 1741, p. 192.
- P. foliis subrotundis, tubis rectis*, Hall. Helv. n. 1009.
- P. minor*, Riv. t. 136. fig. 1. (bona.)—Dill. in Raii Synop. 363.

Lesser Wintergreen.

Habitat in Europæ frigidioris ericetis, dumetis atque sylvis; in Asiâ septentrionali, rariùs. γ . (v. v. sp.)

Radix latè repens. *Folia* numerosa, patentia, subrotundo-ovalia vel elliptica, coriacea, glabra, lucida, viridia, margine repando-crenulata, apice mucronulata. *Petioles* unciales aut sæpiùs ultra, dilatati, paginâ foliorum breviores, margine membranacei. *Scapi* erecti, 3—4-pollicares, quadrangulares, medio squamâ lanceolatâ membranaceâ instructi, hæud convoluti. *Racemus* spicatus, densus, 12—14-florus. *Pedicelli* decurvi, bracteis lanceolatis acuminatis multò breviores. *Flores* globosi, penduli, albi roseo tincti: ore coarctato. *Calycis laciniæ* brevissimæ, semiovatæ, acutæ. *Petala* orbiculata, genitalibus longiora. *Stamina* primò basi reclinata, demùm erectentia: *filamenta* brevia, alba, æqualia: *antheræ* subcordatæ, flavæ, foraminibus sessilibus latissimis approximatis aperientes. *Pistillum* stamina æquans: *stylus* rectus, brevis: *stigma* peltatum, planiusculum, rotato-5-lobum.

The *P. minor* is readily distinguished from *P. media* by its straight style, equal the length of the stamens, and

shorter than the petals; by its spiked and closer raceme; the pedicels being twice or three times shorter than the bracteæ; the scape being straight, not convolute; the petioles being shorter than the leaves, which are repandly crenate.

The acute RIVIN has given very accurate figures of the different species of *Pyrola*, far surpassing those of his predecessors, and even those of most of the modern botanical writers who have noticed them. He was the first who distinguished the *P. media*, of which he has given a very characteristic figure, under the name of *P. folio obtuso*.

The figure of *P. minor*, in English Botany, possesses many glaring faults; the flowers are exhibited as spreading, and the petals acute. These mistakes are the more remarkable, as we know of no *Pyrola* with acute petals, and very few with spreading flowers. The *P. rosea* of the same work, however, is a very good representation of the present plant.

11. *P. secunda*, foliis ovatis acutis membranaceis argutè serratis petiolo angusto longioribus, racemo unilaterali, laciniis calycinis rotundatis, petalis oblongis, stylo exserto, stigmate planiusculo 5-lobo.

- P. secunda*, Linn.—Sp. Plant. 567.—Pall. it. Sib. 3. p. 319.—Falk. Russis. Topog. 2. p. 177.—Scop. Carn. n. 485.—Poll. Pal. n. 397.—Fl. Dan. t. 402. (mala.)—Huds. Angl. 176.—Lightf. Scot. p. 219.—Olaus it. Island. p. 814.—Hoffm. Germ. 143.—Mat. Siles. 1. 293.—Krocker, Siles. 2. p. 13.—Roth. Germ. I. 181. II. 463.—Willd. Sp. Pl. 2. p. 621.—With. Brit. 401.—Smith Brit. 2. p. 445.—Engl. Bot. t. 517. (media.)—Mich. Amer. 1. p. 250.—Lam. Fl. Fr. 2. p. 529.—Lam. Encycl. 5: p. 742.—Persoon Syn. 1. 483.—Marsch. a Bieb. Fl. Taur.-Cauc. 1. p. 313.—Geners. Elench. n. 361.—Besser. Galiz. n. 489.—Wahlenb. Lapp. p. 110. ejusd. Fl. Carpath. p. 115.—Pursh Amer. Sept. 1. p. 299.
P. racemo unilaterali, Linn. Suec. 332.—Hall. Helv. n. 1008.—Gmel. Sib. 4. p. 129. t. 56. f. 2. (pessima.)
P. floribus uno versu sparsis, Linn. Lappon. 168.
P. folio mucronato, Riv. t. 138. f. 2.
P. folio mucronato serrato, C. Bauh. Pin. 181.—Tournef. Inst. 256.—Raii Synop. 363.—Moris. Hist. 1. sect. 12. t. 10. f. 4.
P. folio serrato, J. Bauh. Hist. 3. p. 2. 536.
P. secunda tenerior, Clus. Hist. 2. p. 117. (fig. benè.)—Ger. em. 408.
Ambrosia montana, Dalech. Hist. 1148.

Serrated-leaved Wintergreen.

Habitat in dumetis et sylvis alpinis præsertim pinetis muscosis siccis, Europæ, Asiæ et Americæ boreales copiosè.
h. (v. v. sp.)

Radix repens. *Caules* plures, 3—4-unciales, sublignosi. *Folia* ovata, acuta cum mucronulo, tenuitè ac argutè serrata, submembranacea, glabra, supra lucida, venis reticulatis conspicua, nunc basi acuta, nunc rotundata. *Petioli* uncialles, angustè lineares, simplices, paginâ foliorum breviores. *Pedunculus* erectus, obtusè angulatus, 3—5-pollicaris, squamis 4 v. 5 oblongo-ovatis margine scariosis crispulatis instructus. *Racemus* elongatus, multiflorus. *Pedicelli* unilaterales, decurvato-penduli, bracteis oblongis acutis vix longiores. *Flores* campanulati, albi, viridi pallido tincti. *Calycis laciniæ* brevissimæ, rotundatæ, obtusæ, margine membranaceæ, laceratæ. *Petala* oblonga, stamina subæquantia. *Filamenta* subulata, alba, primò bicurvata, demùm erectentia. *Antheræ* subtetragonæ, 4-sulcæ, foraminibus sessilibus latissimis aperientes. *Stylus* semper porrectus, staminibus petalisque longior. *Stigma* planiusculum, 5-lobum, disco depressum.

DIVISIO SECUNDA.

SECT. I.

12. *P. uniflora*, flore solitario, antherarum foraminibus elongato-tubulosis, stigmatè acutè 5-dentato, foliis orbiculatis serratis.

- P. uniflora*, Linn.—Sp. Plant. 568.—Pall. it. 3. p. 287.—Gort. Ingr. 66.—Georgi Fl. Baikal. p. 124.—Scop. Carn. n. 486.—Poll. Pal. n. 399.—Fl. Dan. t. 8. (bona.)—Hoffm. Germ. 144.—Mat. Siles. 1. 296.—Krocker Siles. 2. p. 15.—Roth. Germ. I. 181. II. 464.—Willd. Sp. Pl. 2. p. 622.—With. Brit. 401.—Smith Brit. 2. p. 446.—Engl. Bot. t. 146. (media.)—Mich. Amer. 1. p. 251.—Lam. Fl. Franc. 2. p. 529.—Lam. Encycl. 5, p. 743.—Persoon Synop. 1. 483.—Geners. Elench.

- n. 363. Besser. Galiz. n. 490.—Wahlenb. Lappon. p. 110. ejusd. Fl. Carpath. p. 115.—Pursh Amer. Sept. 1. p. 299.
 P. scapo unifloro, Linn. Fl. Lapp. 167.—Succ. 334.—Gmel. Sib. 4. p. 129. n. 19.—Hall. Helv. 1011. it. Hercyn. n. 21.
 P. rotundifolia minor, C. Bauh. Pin. 191.
 P. minima alpina, J. Bauh. Hist. v. 3. p. 2. 536,
 P. singulari flore ampliore, Moris. Hist. 3. p. 505. sect 12. t. 10. f. 2. (benè.)
 P. flore singulari, Riv. Pent. Irreg. t. 139. f. 1. (bona.)
 P. quarta minima, Clus. Hist. v. 2. 118.—Ger. em. 408.

Single-flowered Wintergreen.

Habitat in sylvis alpinis muscosis Europæ, Asiæ et Americæ Septentrionalis copiosè. 4. (v. sp.)

Planta omnibus minor. *Radix* repens. *Folia* patentia, terna rariùs quaterna, orbiculata, membranacea, glabra, serrata, reticulatim venosa, petiolo dilatato longiora. *Scapus* erectus, filiformis, gracilis, 3-4 pollicaris, squamâ ovatâ supra medium instructus. *Flos* magnus, solitarius, cernuus, albus, odore fragrantissimo gaudens. *Calycis laciniæ* ovales, obtusæ, petalis triplò breviores. *Petala* latè ovalia, patentia, multinervosa, staminibus duplò longiora. *Stamina* per paria, approximata, recumbentia, petalis opposita: *filamenta* dilatata: *antheræ* farctæ: *foraminibus* elongatis, tubulosis, incurvis. *Pistillum* staminibus longius: *stylus* rectus, crassus: *stigma* magnum, acutè 5-dentatum.

SECT. 2. CHIMAPHILA.

13. *P. umbellata*, foliis cuneato-lanceolatis serratis quaternis senisve, pedunculo pubescente corymbifero, bracteolis lineari-subulatis, appendicibus filamentorum ciliatis, stylo immerso.

- P. umbellata*, Linn.—Sp. Plant. 568.—Poll. Pal. n. 398.—Hoffm. Germ. 144.—Mat. Siles. 1. n. 295.—Krocker Siles. 2. p. 14.—Roth. Germ. 1. 151. II. 464.—Willd. Sp. Plant. 2. p. 622.—Mich. Amer. 1. p. 251.—Lam. Encycl. 5. p. 744.—Bot. Mag. t. 778. (optima.)—Persoon Synop. 1. 483.
 Chimaphila corymbosa, Pursh Amer. Sept. 1. p. 300,
 Chimaza umbellata, Brown in Herb. Banks,
 P. pedunculis subumbellatus, Linn. Succ. 333.—Gmel. Sib. 4. p. 129. Sib. 4. p. 129. n. 18,
 P. folio arbuti, Riv. Pent. t. 139. f. 2. (bona.)

- P. fruticans* arbuti folio, C. Bauh. Pin. 191.—Tournef. Inst. 256.—
Moris. Hist. 3. sect. 12. t. 10. f. 5.
P. fruticans, J. Bauh. 3. p. 536. (icone.)
P. 3. fruticans, Clus. Stirp. Pann. 507.—Hist. p. 117. (icone benè.)

Umbel-flowered Wintergreen.

Habitat in sylvis glareosis et sabulosis Europæ, Asiæ et Americæ frigidioris. *h.* (v. v. c. et s. sp.)

Planta frutescens, sempervirens. *Radix* prorepens. *Caulis* erecti, 4-pollicares v. sæpè palmares, teretes, glabri, virides. *Folia* 4—6-verticillata, utrinque viridia, cuneato-lanceolata, coriacea, glabra, lucida, reticulatim venosa, margine e medio ad apicem acutè ac distantè serrata, petiolis sexies longiora. *Pedunculi* recti, rubescentes, teretes, 3—4-pollicares, 5—6-flori, pube brevissimâ undiquè densè tecti. *Flores* corymbosi, penduli, demùm erectentes, viridi-albi, rubro tincti. *Calycis laciniæ* rotundatæ, margine fimbriatæ. *Petala* 6, orbiculata, concava, imbricatim conniventia, margine tenuissimè ciliata. *Stamina* brevia: *filamenta* subulata, purpurea, stipitata: *stipitum disco* plano circinato, margine ciliato: *antheræ* violacæ: *foraminibus* tubulosis orâ revolutâ. *Ovarium* viride: *stylus* ovario immersus: *stigma* virens, latè dilatatum, convexum: *disco* 5-fisso.

14. *P. maculata*, foliis lanceolatis acuminatis inciso-serratis discoloribus oppositis ternisve, pedunculo pubescente corymbifero, bractcolis linearibus, appendicibus filamentorum lanatis, stylo brevissimo.

- P. maculata*, Linn. Sp. Plant. 568.—Mill. Dict. n. 4.—Willd. Sp. Plant. 2. p. 622.—Mich. Amer. 1. p. 251.—Lam. Encycl. 5. p. 743.—Perseon Synop. 1. 483.—Bot. Mag. t. 897. (optima.)
Chimaphila maculata, Pursh Amer. Sept. 1. p. 300.—Nuttall Gen. Plant. Amer. bor. 1. p. 275.
Chimaza maculata, Brown in Herb. Banks.
P. petiolis apice bifloris vel trifloris, Gron. Virg. 48.
P. Marilandica minor, folio mucronato arbuti, Pet. Mus. 675.
P. Mariana, arbuti foliis angustioribus, trifoliata ad medium nervum lineâ albâ utrinque per longitudinem discurrente, Pluk. Mant. 157. t. 349. f. 4.

Spotted Wintergreen.

Habitat in Americæ borealis sylvis arenosis. h. (v. v. c. et s. spont.)

Planta suffrutescens, sempervirens. *Radix* prorepens. *Caules* procumbente-adscendentes, 3—4 pollices longi, glabri, teretes, rubri. *Folia* opposita aut quaterna, brevè petiolata, lanceolata, acuminata, basi obtusa, rariùs ovato-lanceolata, coriacea, glabra, lucida, margine inciso-serrata, *serraturis* distantibus, acutis; *paginâ superiore* fasciâ albâ ad nervum medium et venas notatâ; *inferiore* rubrâ. *Pedunculus* cylindricus, pubescens e medio foliorum ortum ducens, 3—4-pollicaris. *Umbella* rariùs corymbus, 2—3-flora. *Pedicelli* uniflori, calycesque rubri, pube brevi glutinosâ tecti, bracteolis linearibus ad medium instructi. *Flores* penduli, candidi. *Petala* subrotunda, concava, ad expansionem reflectentia, margine tenuissimè fimbriata. *Lacinix calycinæ* rotundato-ovatæ, ciliatæ. *Filamenta* brevè subulata, viridia stipitata: *stipitum disco* circinato, villosissimo. *Antheræ* luteæ: *foraminibus* tubulosis ora revolutâ. *Ovarium* globosum, viride: *stylus* brevissimus distinctus: *stigma* virens, orbiculatum, convexum: *disco* 5-fisso.

15 *P. Menziesii*, foliis alternis ternisve lanceolatis acuminatis serratis discoloribus, pedunculo glabro bifloro, bracteolis latè rotundatis, laciniis calycinis ellipticis acutis, stylo distincto.

P. Menziesii, Brown in Herb. Banks.

MENZIES'S Wintergreen.

Habitat in Americæ orâ boreali-occidentali. MENZIES, h. (v. s. in Herb. Banks. et Lamb.)

Planta suffrutescens, sempervirens. *Radix* repens. *Caules* supernè adscendentes, 2—3 pollices longi, teretes, glabri, rubri. *Folia* lanceolata, acuminata, coriacea, gla-

bra, nitida, brevissimè petiolata, basi subacuta, margine approximato-serrata, suprâ intensè viridia, immaculata, subtùs rubra. *Pedunculus* erectus, gracilis, filiformis, sesqui v. biuncilis, glaberrimus, ruber, apice dichotomus, 2-florus. *Pedicelli* glabri, gracillimi, uniflori, bracteolo latè rotundato infra medium instructi. *Flores* penduli, candidi. *Lacinia calycina* ellipticæ, acutæ, glabræ. *Petala* ovalia ad expansionem reflectentia. *Filamenta* brevia, viridia: *stipitum disco* circinato, barbato. *Antheræ* oblongæ: *foraminibus* tubulosis, ora rectâ haud revolutâ: *stylus* viridis, brevis præcedente duplò longior: *stigma* virens, hemisphæricum: *disco* 5-fisso.

In the Lambertian Herbarium, I had ascertained this to be a species distinct from *P. maculata*; and on examining the genus in the Banksian Herbarium, I was glad to find it confirmed as such, by its being previously determined and named by Mr BROWN.

It certainly has a striking resemblance to *P. maculata*, and without careful examination might readily be overlooked for that species. The plant, however, is much smaller. The leaves are somewhat acute at the base, never spotted on the upper surface, and often alternate,—a circumstance which I have never remarked in *maculata*. The peduncles are much slenderer and shorter, quite smooth, never bearing more than two flowers. The lacinia of the calyx are oblong-ovate, acute, quite smooth, as well as the pedicels. The bractea are very different from those of *maculata*, being broad and round. The petals are oval. The appendage of the filaments is not so hairy. The tubular pores of the antheræ have a straight margin, never revolute as in *P. umbellata* and *maculata*. The style is much longer, and somewhat elongated from the germen. The stigma is smaller, and hemispherical.

XIII.—*Descriptions, Characters, and Synonyms
of the different Species of the Genus Larus,
with Critical and Explanatory Remarks.*

By W. MACGILLIVRAY, A. M.,

Member of the Medical Society of Aberdeen, and Corresponding Member of
the Wernerian Society.

(*Read 10th January 1824.*)

THERE is scarcely a genus of birds in which more confusion has reigned than in that which forms the subject of the present memoir. To those versed in the study of birds, and especially to those who have laboured to acquire a knowledge of the species which are found in our own country, no apology is necessary for an attempt to dissipate the uncertainty and doubt which every one experiences on comparing the specimens which he may have procured with the descriptions of authors. To the student alone, it may be necessary to observe, that the species of gulls, forming a very natural genus, and being, in many cases, most closely allied in manners, in colour, and in size,—and, moreover, presenting much particular diversity, chiefly with respect to plumage at different ages, in the same species,—together with a strong general resemblance in different species during the first years,—are very difficult to distinguish by a

mere examination and comparison of specimens, and, still more so, by attempting to refer them to the species established by naturalists.

My object being to exhibit the subject in as clear a light as possible, I shall, in the first place, give a short but circumstantial account of the genus considered individually, and then proceed to the particular species. But previous to this, it will be proper to observe, that the paper, such as it is, owes its existence to Professor JAMESON, who, aware of the uncertainty that prevails in this very interesting genus, wished me to attempt its elucidation. The specimens, which have furnished the principal materials of this necessarily imperfect memoir, form part of the splendid collection of birds in the Museum of the University; the descriptions are in all cases taken from actual specimens, and the specific characters elaborated without any reference to those of authors. For the variations exhibited in the young birds, as well as information on other points, I have trusted implicitly to TEMMINCK and MONTAGU: wherever information has been derived from other sources, it will be faithfully acknowledged.

LARUS, GULL.

Natural Generic Character.—Beak of moderate length, straight, compressed, the sides rounded, the edges bent inwards and sharp; the upper mandible declinato-incurvate at the end, sharpish; under mandible forming a prominent angle near the end, at the junction of its crura, obliquely truncate and grooved internally at the tip.

Nostrils lateral, mesial, longitudinal, linear, with the fore-end rounded, open, perforated.

Feet rather slender, moderately long, bare above the knee: tarsi squarish, plates anteriorly, covered behind and at the knee with hexagonal scales; toes, three before, the middle one of moderate length, all palmate to the end, hind toe (sometimes wanting) very small, elevated; claws slightly arcuate, shortish, bluntish, increased interiorly into an edge.

Wings long, the first quill longest, the second nearly equal; scapulars longish.

Tail equal or slightly rounded, of twelve feathers.

Note.—In the larger species the beak is very deep, and the knob or protuberance of the lower mandible very distinct; the beak becomes shallower and more attenuated, and the knob nearly disappears in the smaller species. With regard to the tail, there are two remarkable and opposite exceptions; the one existing in the *Larus Sabini*, which has the tail furcate, like that of a Tern; the other in *L. roseus* *, in which it is subcuneate, the middle feathers being considerably longer, the rest graduated.

Physiognomy.—In their general appearance, the Gulls are intermediate between the diving aquatic birds and the Grallæ, and their manners correspond with this character. The head is large, the beak moderately long, the neck shortish, the body deeper than broad, the wings long, the tail moderate, the feet somewhat slender, and bare a little above the knee. They are clothed with a very fine elastic plumage, plentifully supplied with down. The predominating colours are pure white, pale greyish-blue tinged with purple, deep slate-purple, and various tints of brown. There is no difference between the sexes in point of colour: the females are somewhat smaller.

* The name given *pro tempore* to a new species of gull, discovered by the last Arctic expedition, but which is to receive its proper designation from Dr RICHARDSON.

Manners.—The gulls are in general voracious, noisy and timid birds, which seek their subsistence along the shores or on the surface of the sea. They are incapable of diving, although they swim with ease; and their appearance upon the water is much more elegant than on shore, owing to their peculiar lightness, and the superior agility which they then display. They are much upon the wing; their flight is strong and buoyant; and, when flying, they utter a loud cry, more or less deep or shrill, according to the size of the species, and divided by short intervals. In their state of repose, they contract the neck, and generally draw one foot up. They perform a singular action with their feet upon the sands, patting then repeatedly with considerable celerity, and at the same time retiring backwards: the object of this action is not well understood, though it may be presumed to be the discovery of worms or other animals concealed in the sand. In winter they congregate in large flocks, at the mouths of rivers, or on the sands, as well as in the breeding season, when they form a more promiscuous assemblage.

Food.—Their food consists of every thing indiscriminately that they can obtain, without the exercise of courage or address, from the flesh of dead cetacea to the smallest worm. They break open the shells of crabs with their beaks, and those of cockles, by letting them fall from a sufficient height in the air. As they do not swim, their mode of catching fishes is by darting upon them as they approach the surface; for this purpose they pursue the shoals of herrings and sand-eels (*Ammodytes Tobiannus*); but their usual supply of fish is derived from those which are casually thrown upon the beach. Young birds also fall a prey to the larger species. In stormy weather gulls sometimes leave their ordinary haunts, and proceed inland, especially in spring-

time, to pick up the larvæ and worms exposed by the plough.

Breeding.—Nothing is known with precision in regard to the period of incubation. Their nests are composed of dried grass, arranged in a slovenly manner, and deposited in a superficial cavity in the turf, or not unfrequently on the bare rock. The number of eggs is generally three. The young are at first covered with a very fine thick down: they leave the nest very soon after exclusion, and secrete themselves in crevices, or behind stones; but they do not take to the water till they are fully fledged. The young birds are mottled with dull-grey, and brownish; the beak and feet, as well as the iris, are at first dark, and become lighter as the bird advances in age: the full and permanent plumage is not acquired in general till the third year. After this, at the autumnal moulting, the head and neck in many become streaked with pale brown lines, which disappear in spring.

Country.—This genus is not confined to any particular portion of either the Old or New Continent, being found everywhere, along the shores, from the frozen regions of the North to those of the South Pole, and appearing equally in the Torrid Zone. Their partial and general migrations have not been sufficiently explained.

Uses.—In the economy of Nature, one of the principal uses of these birds may be to clear the coast of animal remains, which would otherwise produce a noxious effect by putrefaction; in the same manner as the vultures, crows, and eagles, perform this office in the interior of the continents and islands. This may in some degree explain their general diffusion. With regard to man, they do not seem

to be of much immediate importance. Their flesh is tough, generally lean, and disagreeable in taste and flavour: the young and the smaller species, however, are eaten occasionally in the outer Hebrides, and probably in other countries. Their plumage, if it could be procured in sufficient quantity, is much superior to that of most other aquatic birds, for the ordinary purposes to which feathers are applied.

Affinities.—However the Gulls may be placed in the systems of ornithologists, their true position in the system of Nature is evidently between the Petrels or Albatrosses and Terns. There is a striking affinity, on the one hand, between the *Diomedea exulans*, or *Procellaria glacialis*, and the *Larus marinus*, or *argenteus*; and, on the other, between the *Larus Sabini* and *minutus*, and the *Sterna hirundo* and *minuta*. The four genera, in fact, form a very natural family, closely allied in aspect and in manners. The genus *Lestris*, which is by many considered as identical with the present, and by others as at least most closely allied to it, I would not even place within several degrees of affinity.

It has been customary to divide the species of this genus into large and small, giving the former the name of Golelands, and the latter that of Mouettes, terms which have their equivalents in the English words Gulls and Mews. This division, altogether arbitrary, and having no foundation in nature, I would reject. Perhaps a better mode of division might be derived from the prevailing colour of the mantle or back,—or, which would be more eligible, from the form of the tail, which is even, or furcate, or cuneate. In the latter case, however, the second and third divisions would contain but a single species each. It is better to consider the whole as one undivided genus, commencing with the short and deep-billed species, such as *L. bathy-*

rinchus and *marinus*, which are also among the largest,—and ending with those in which the bill is most attenuated, such as *L. minutus* and *roseus*, which are the smallest species of the genus.

1. *Larus bathyrinchus*, *Great-billed Gull*.

L. rostro pone apicem utrinque gibbo, rubro, dorso alisque ardoisiaceis ¹, remigibus caudæque sub apice fasciâ nigris.

Adult.—Beak shortish ², very deep, much compressed, gibbous in the lateral view both above and below beyond the middle, ochre-yellow to the fore part of the nostrils, bright-red at the end: length $2\frac{3}{8}$ inches, depth at the knob 1 inch. “Irides and corner of the mouth bright scarlet. Feet greenish-yellow ³,” claws blackish-brown; tarsus $2\frac{1}{2}$ inches long, middle-toe ⁴ $2\frac{5}{8}$ inches. Wings reaching to a little beyond the tip of the tail. Total length $24\frac{5}{4}$ inches, extent 52 inches. Back and wings slate-purple; primaries brownish-black, from the seventh primary to the last secondary quill the tips white, forming a terminal bar, which is broadest in the middle; the rest of the plumage snow-white, with the exception of a band of brownish-black across the tail near the end, including the whole of the feathers, excepting the outer, which have only the shaft slightly marked. Variations dependent upon age, incubation, manners, uses, &c. unknown.

1 Brown, with a little ash-grey and red, upon a blackish basis.

2 Not quite so long as the head.

3 Parkinson.

4 Including the nail.

Country.—Coasts of New Holland.

Distinctive Characters.—This species, although one of three that are equally black or purple backed, is easily distinguished by the remarkable depth and gibbosity of the beak, as well as by the dark band across the tail.

Synonyms.—*Larus leucomelas*, TEMM. Man. d'Ornith. P. ii. p. 760, note.—*L. marinus*, LATHAM, Ind. Orn. ii. p. 813.—*Black-backed Gull*, LATH. Gen. Syn. vi. p. 371: it being in all probability the species which PARKINSON mentions in his Journal, as occurring upon the coast of New Holland; and which LATHAM, being unacquainted with the *L. bathyrinchus*, as above characterised, naturally supposed to be the following species. PARKINSON'S words are, “ a large black and white Gull, with a bright yellow beak, on the gibbous part of which was a spot of scarlet; the corners of its mouth and irides of the eyes were of a bright scarlet colour, the legs and feet a greenish yellow.” PARKINSON'S Journal, p. 145.

Remarks.—The above description is taken from a specimen in the Museum of the University of Edinburgh, and agrees in all essential respects with that given by TEMMINCK, from a specimen in his own possession. It may not be amiss to subjoin the character as given by himself. “ *Larus leucomelas*, VIEILL. Beak very strong, short, suddenly bulging toward the end; nostrils ovoidal; the whole plumage of a pure white; mantle and wing black; the tail white, having toward the extremity a broad band of a deep-black colour; primary quills all black; beak yellow, point reddish; feet yellow; length of the tarsus 3 inches. Total length 23 inches.” Man. d'Ornith. p. 760, note.

The name *leucomelas* is evidently improper, being equally applicable to this and the two following species, which are all λευκομελανες; *bathyrinchus* expresses the most essential characteristic of the species, and is therefore a better name.

2. *Larus marinus*, *Carrion Gull*.

L. rostro superne leniter aucto, dorso alisque ardoisiceis, pennis apice albis, prioribus quinque (vel inter-dum sex) nigricantibus, alis caudâ brevioribus.

Adult, Winter Plumage.—Beak, shortish, very deep, much compressed, slightly gibbous above, wine-yellow tinged with gamboge, a bright orpiment spot at the knob of the lower mandible; length $2\frac{6}{8}$ inches, depth at the knob $\frac{7}{8}$ ths. Naked margin of the eyes red, iris yellow marbled with brown. Feet flesh-colour, claws brownish-black; tarsus 3 inches, middle-toe 3 inches. Wings a little shorter than the tail; total length 28 inches, extent 60 inches. Back and wings slate-purple; quills white at the end; first quill nearly all blackish-brown, this colour extending obliquely inwards to the fifth quill, a small spot on the outer web of which only is black; a whitish mark on the inner webs within the black; shaft of first quill nearly white to the middle, of the others corresponding with the colour of the webs. The rest of the plumage snow-white. A few short longitudinal pale brownish streaks on the back of the head and neck; a number of black bristles about the fore-part of the eye.

Adult, Summer Plumage.—Beak bright yellow, an orange spot on the lower mandible, irides fine yellow, eyelids red-orange, legs flesh-coloured; head and neck pure white; the rest of the plumage as in summer.

N. B. The above description of the adult in winter is from a specimen in the Museum. There is commonly a black bar across the white, at the end of the second quill. The markings of the first primaries vary somewhat, the oblique bar of blackish extending sometimes to the fourth, &c. In one specimen, the largest that I have seen, and apparently a very old bird, the beak was 3 inches long, $1\frac{1}{8}$ deep at the knob; tarsus $3\frac{2}{8}$, toe $3\frac{2}{8}$; total length 28, extent 62.

Nidification, &c.—Breeds along the shores, sometimes (in the outer Hebrides at least) retiring inland to a considerable distance from the sea, to nestle in the islands of lakes. Nest generally made in a superficial cavity in the turf, or sometimes on the bare rock, composed of grass and sea-weeds, with occasionally a few feathers. Eggs, according to TEMMINCK, three or four, of a very deep olive-green, marked with some large and small spots of dark-brown. I have never seen more than three eggs in a nest. In the Islands of Harris, the nests are commonly constructed of the cespitose roots of *Statice Armeria* and dried grass, and are usually pretty perfect.

Young Bird, fully fledged.—Beak deep black; iris and naked circle brown; feet of a livid colour; head and fore-neck greyish-white, with numerous brown spots, largest upon the neck; feathers of the upper parts dark-brown in the middle, edged and tipped with reddish-white; transverse bars of this colour on the wing-coverts, lower parts dull grey, with broad zigzag lines and spots of brown; middle tail-feathers with more black than white, lateral black toward the end, all edged and tipped with whitish; quills blackish, a little white at the tip. TEMM.

First Winter Plumage.—Beak bluish black; the extreme tip, and a small portion of the base of the under mandible dusky horn-colour; iris and naked circle brown; feet flesh-colour, tinged with pale blue, inclining to verdigris green about the knee; claws blackish-brown. Head light grey, streaked with pale brown; throat greyish-white: ocular bristles blackish; back confusedly mottled with hair-brown, on a brownish-white basis, tinged with yellow, in patches increasing in size and deepness of tint downwards; wings mottled in the same manner, but the brown deeper, approaching to liver-brown; primaries, primary-coverts, and secondaries, blackish-brown. The arrangement of dark colour on the back is in single spots on each feather, which also prevails on the wing-coverts; but the quill-coverts have the inner webs brown, with processes to the number of four shooting into the light colour of the outer webs, the intervals ash-grey. The bases of the back feathers are pale ash; their edges and tips of the ground colour described above. On the rump and tail-coverts, white predominates; tail-feathers white at the base, with irregular spots and blotches; deep-brown predominates at the end, but is irregularly encroached upon; the side-feathers nearly all white. The whole under-surface whitish, tinged with ash and yellow, with very pale brown spots; under-wing-coverts mottled, brownish-ash and pale brown; axillaries brownish-ash at the base, with irregular bands of pale brown towards the end. The specimen from which this description is taken, is in the possession of Mr JOHN WILSON, and was killed in January 1824.

Second Winter Plumage.—Beak deep-brown, tinged with blue toward the end, the tip horn-colour, the base, especially of the under mandible, yellowish, tinged with brown; angle of the mouth, and naked margins of the eyes yellow-

ish; feet more decidedly flesh-colour; fore part and sides of the head, fore part of the neck, and under surface in general pure white; a few pale brown spots still remaining on the sides, the axillaries, and under-wing-coverts nearly as before; ground-colour of the head and hind neck white, slightly tinged with ash, streaked with pale brown; ocular bristles black; back confusedly mottled with pale brown and yellowish-white, tinged with ash and purplish-brown, having somewhat of a transverse direction; there being several bars on each feather, the tips still whitish, those of the scapulars white to a considerable extent; wings deeper than the back, hair-brown, tinged with grey and a little purple, the spots arranged in irregular bars; the tips and intervals reddish-white, tinged with brown; primaries blackish-brown; secondaries pale brown, tinged with grey, and tipped with white; the proximal ones barred with deep brown and whitish at the end; rump and tail-coverts whitish, slightly mottled with pale brown; tail-coverts nearly all white, with a few very deep brownish-black spots and patches; an irregular bar of the same deep brown at the end, the tips whitish. This description is also taken from a specimen, for which I am indebted to Mr JOHN WILSON.

At the age of two years.—After the autumnal moulting, the back and wings begin to assume their deep colour; they are then of a deep purplish-brown, variegated with irregular brown and grey spots; the tail is marbled with brownish; the beak assumes the red spot, with black in the middle; the rest is a livid yellow, patched with black.
TEMM.

At the third autumnal moulting, the plumage is completed. **TEMM.**

Country.—Inhabits the north of Europe and America,

extending from the Arctic Circle to the Temperate regions. Very abundant in the Hebrides, Orkney and Zetland Islands. TEMMINCK observes, that it is common on the coasts of Holland, France, and England, on its passage; but MONTAGU remarks, that it occurs on the coast of Wales at all seasons, which it also does in the Hebrides. According to TEMMINCK, it is seen, though not abundant, on the Mediterranean; and LATHAM makes it extend to the Cape of Good Hope, and even to New Holland; but whatever the Cape bird may be, the New Holland one is undoubtedly the *L. bathyrinchus*.

Manners and Food.—It is generally shy, unless when enticed by food, or in the breeding season. Like the other species, it is commonly seen along the shores, and, when reposing, takes care to choose a place where it cannot readily be surprised, such as a rocky eminence, the middle of an extensive beach, or the bosom of the sea, at a little distance behind the breakers. It flies strongly, and, when soaring, utters a sort of loud, somewhat hoarse cackle, not unlike the sounds of a short laugh. Its common food is fish; but scarcely any thing comes amiss to it, and it also devours young birds. In the outer Hebrides, where it is very abundant, and where its indiscriminating voracity is proverbial, it is often seen searching the hills and heaths for carrion, which it eats in company with the eagle and raven. According to MONTAGU, it is a great enemy to the fishermen, and will tear and devour the largest fish from the hooks, when left dry by the ebbing tide.

Distinctive Characters.—It is distinguished from the preceding species by its superiority in size, by the different form of bill, the want of the black bar on the tail, &c. For

its comparison with the following species, I refer to the distinctive characters of this latter.

Adult Synonyms.—*Larus marinus*, Lin. Syst. Nat. i. p. 225; Gmel. Syst. i. p. 598; Fab. Fauna Groen. p. 102; Lath. Ind. Orn. ii. p. 813; var. α .; Temm. Man. d'Orn. ii. p. 760.—*Black-headed Gull*, Lath. Genl. Syn. vi. p. 371; Penn. Brit. Zool. ii. p. 172; Arct. Zool. ii. p. 527.—*Great Black-backed Gull*, Mont. Orn. Dict.—Young. *Wagel Gull*, Lath. Syn. vi. p. 375; Penn. Brit. Zool. ii. p. 182; Arct. Zool. ii. p. 528.—*Larus naevius*, Gmel. Syst. i. p. 598.—*Larus marinus*, var. γ , Lath. Ind. ii. p. 814.

Remarks.—The specific name *marinus*, usually applied to this gull, is a very absurd one, all gulls being essentially *marini*, and this having no claim to a peculiar appropriation of the term. The English name of Black-backed is also a very unfortunate one, as may be seen by referring to the description of the preceding and following species.

3. *Larus fuscus*. *Dusky Gull*.

L. rostro superne leniter aucto, dorso alisque cinerascenti-ardoisiaceis, pennis apice albis, prioribus quinque nigris, extera sub apice albo notata, alis cauda longioribus.

Adult, Winter-Plumage.—Beak moderate, deep, much compressed, slightly gibbous above, as well as below, lemon-yellow, a bright orpiment spot at the knob; length $2\frac{1}{2}$ inches, depth of the knob $\frac{5}{4}$ ths. Naked circle of the eyes red-orange, iris very pale yellow. Feet bright gamboge-yellow, claws brownish-black; tarsus $2\frac{1}{2}$ inches, toe $2\frac{5}{8}$.

Wings about 2 inches longer than the tail. Total length 23 inches, extent 46 inches. Back and wings deep brownish-purple, with a tinge of ash-grey. Four first primaries brownish-black, this colour extending, but diminished in extent, to the sixth or seventh; shafts corresponding with the colour of the webs; a white spot near the end of the first; the rest of the primaries tinged with grey; the whole with more or less white on the tip, sometimes obsolete on the first and second, and very narrow on the next three; secondaries, and some of the scapularies, white at the end; the rest of the plumage pure white; a few longitudinal short streaks of very pale brown on the head and back of the neck.

Adult, Summer Plumage.—The same as in winter, only that the brown streaks have disappeared. TEMM.

Note.—The greater part of the quills are often truncate, with the shaft exserted, in which case the white tip of the primaries is reduced to a mere line. Most authors, and with the rest TEMMINCK, LATHAM, and MONTAGU, describe a spot of white near the end of the first and second quills. In the specimens which I have seen, it was only the first that had this spot.

Nidification.—Nest composed of withered plants, and placed in situations similar to those chosen by the preceding species; according to TEMMINCK on the sands also, or on sand-banks. Eggs two or three, brownish-grey, spotted with black; according to MONTAGU, they are so like those of the *L. argenteus* as not to be distinguishable; that is, dark olive-brown, with dusky blotches. The young, according to MONTAGU, are covered with brown down, mottled with dusky.

Young Bird of the first year.—Beak brown at the base, and black toward the tip; feet dull ochre-yellow. Throat and fore part of the neck whitish, with longitudinal streaks of pale brown; neck and under parts whitish, almost entirely covered with large spots of very deep brown; upper parts and wings, with the feathers blackish-brown in the middle, margined with a narrow yellowish band; tail-feathers at the base pale grey marbled with black, the rest blackish-brown, excepting the tips, which are whitish; quills deep black. TEMM.

Other stages not known with certainty, though they may be inferred to be analogous to those of the preceding species.

Country.—This species is found in summer in all the northern parts of Europe and America; in England, and on the Baltic. In autumn, on its passage southward, is seen on the coasts of France and Holland; more common on the Mediterranean than the preceding species. TEMM.

Manners and Food.—The manners of this species are pretty similar to those of the last. Like it, also, it sometimes proceeds to a considerable distance inland in quest of food. MONTAGU observes, that it is much less numerous than the preceding species.

Distinctive Characters.—In the adult state this species is distinguished from the preceding, by its great inferiority of size, by the greater proportional elongation of the beak, by the bright yellow colour of the feet, those of the other being pale flesh-colour, by the different tint of the back and wings. We have as yet no good distinctive characters between the young of this species and of the *L. argenteus*, which are nearly equal in size. MONTAGU professes to be

unable to discriminate between them; and TEMMINCK passes over the subject in silence. The young of all the large gulls known by the older writers have been variously confounded by them, and indifferently described under various names, such as *Wagel*, *L. naevius*, &c.; all which it were better entirely to forget.

Synonyms.—Adult. *Larus fuscus*, Lath. Ind. Orn. ii. p. 815; would appear to be var. β of *L. marinus* of the same author, Ind. Orn. ii. p. 814; Temm. Man. d'Orn. ii. p. 767.—*Less Black-backed Gull*, Mont. Orn. Dict.—*Silvery Gull*, Lath. Syn. vi. p. 375.

Remarks.—The term *argentatus* signifies properly, not *silvery*, but *silvered*; that is, denotes, not the colour of silver, but a deep brown or blackish colour, with a shade or washing of whitish or light grey upon it. In this sense it is commonly taken by the French naturalists; take, for example, *le Renard argentée* (*Canis argentatus*), the fur of which is described as “*de couleur noir, à laquelle se mele quelque peu de blanc.*” DESMAR. Looking upon the word *argentatus* in this light, some have applied it as a specific name to the present species. Others, considering it as expressive of a tint resembling that of silver, and observing that this tint does not belong to the species in question, have applied the name of *argentatus* to another species, giving to the present that of *fuscus*. This difference of opinion with regard to the true signification of the term, has given rise to a good deal of confusion. The name of *argentatus* is fully as applicable to the present species as that of *fuscus*; but as TEMMINCK retains the latter, after LINNÆUS and others, it may as well remain.

4. *Larus argentus*. *Silvery Gull*.

L. rostro superne leniter aucto, dorso alisque cœrulescenti-perlaceis, pennis apice albis, rectricibus quinque nigris, alis caudâ longioribus.

Adult, Summer Plumage.—Beak moderate, deep, compressed, slightly gibbous above, gamboge-yellow along the edge of the upper mandible, diaphanous at the tip and margins of both mandibles, the rest wine-yellow, a deep reddish-orange spot on the under; angle bright red; length 2 inches, depth $\frac{5}{8}$ ths. Iris pale yellow, margin of the eyes yellow. Feet flesh-colour, claws blackish-brown; tarsus $2\frac{1}{2}$ inches long, middle toe $2\frac{3}{4}$. Wings about an inch and a half longer than the tail. Total length 24 inches, extent 50. Back and upper surface of the wings pearl-grey, with a good deal of blue; a broad oblique blackish-brown band passing over the five first quills, so large on the outer as to include nearly the whole, diminishing to the fifth, on which there is merely a bar near the end; second quill with a black bar across the white of the tip; the colour of the shafts corresponding with that of the webs. The rest of the plumage snow-white.

Adult, Winter Plumage.—Head and neck marked with longitudinal streaks of pale brown; in other respects the same as in summer.

Nidification, &c.—Nest in a superficial cavity in the turf, or on the bare rock, along the shores, and especially in rocky islets, composed of withered grass, and sometimes a few feathers, commonly pretty perfect. Eggs 3, placed irregularly, olive-green, sometimes with a good deal of ash-

grey, blotched and spotted with brownish: there is a considerable variation in the ground-colour, as well as in the form of the markings and their tints.

It has not been the custom with ornithologists to observe the young birds before they have left the nest. I have before me a specimen (the examination of which I owe to the liberality of Dr RICHARDSON), from the last expedition under Captain PARRY, which is about a week old, and is marked "Young of *L. argentatus*, 17th August 1821, Duke of York's Bay;" the tip of both mandibles is wine-yellow, the rest of the beak pale brown; the feet dusky, the claws yellowish. The whole body is closely invested with a dense, long, and very soft down, greyish-white on the breast and belly, of a deeper tint on the rest, mottled with brownish-grey, the spots on the head deepest.

Young Bird, fully fledged.—Head, neck, and under parts, deep grey, variegated with numerous spots of pale brown; feathers of the upper parts pale brown in the middle, edged with a narrow reddish band, tail-feathers more brown than white, of the latter colour at the base, all terminated by reddish-yellow; quills blackish-brown, a little white on the tip; beak blackish-brown, iris and circle of the eyes brown; feet of a livid brown. TEMM.

From the first year to the autumn of the second year, all these colours become paler, and the white more extended; the bill remains dusky, the irides get somewhat paler. TEMM. and MONT.

After the second autumnal moulting, the bluish feathers of the back make their appearance; the irides get lighter, inclining to yellow; the beak becomes yellowish at the base, the tail mottled with the terminal bar as at first; the head, neck, and under parts of the body whitish, streaked with dusky. TEMM. and MONT.

At the second spring moulting, the blue of the back and wings is perfected. TEMM.

After the third autumnal moulting, the head and neck still streaked with dusky, and the tail marked with a little dusky down the shafts of the middle feathers. MONT.

At the fourth autumnal moulting, the tail is perfected, and the adult winter plumage complete. TEMM.

At the fourth spring moulting, nothing remained to be perfected, in a specimen kept by MONTAGU, but the point of the bill, which was a little dusky; the head and neck became pure white, as it should do at that season, in the adult. MONT.

Country.—Abundant in all the cold and temperate parts of Europe and America, along the shores, and occasionally appearing along the rivers and on the lakes.

Manners and Food.—This species is more allied in its manners to the smaller than to the larger species, and does not, like the latter, feed upon carrion, but pursues, with the *L. canus*, and others, the shoals of herrings, and frequents the sands, where it picks up worms, asteriæ, cockles, and sand-eels.

Distinctive Characters.—In the adult state, this species can only be confounded with the *L. arcticus*, to which I refer for a minute diagnostic description. The young, before the blue colour of the back appears, are liable to be confounded with those of *L. fuscus* and *L. marinus*, though they may always be distinguished from the latter by their inferiority in size. TEMMINCK does not appear inclined to enter upon this subject, and MONTAGU confesses his inability to distinguish them in a satisfactory manner. This therefore remains one of the desiderata in the history of the genus.

Synonyms.—*Larus argentatus*, Temm. Man. d'Orn. pt. ii. p. 764.—*Herring Gull*, Mont. Orn. Dict.

I am sorry that no more synonyms can be given with certainty: authors have so confounded this, and the *L. fuscus*, as well as others, that it were to little purpose to exhibit a critical view of their blunders.

Remarks.—The adult birds of this species vary considerably in size; the largest which I have seen were 25 inches in length, and the smallest 22. There is also considerable variation in the markings of the outer primaries: in some specimens the black bar of the primaries extends to the sixth, there being a spot on its outer web, but it usually terminates on the fifth. A large portion of the ends of the first and second quills being white, in other specimens there is a spot of black on the outer web of the first, and a bar across the second. In a specimen from the last Arctic Expedition, the primaries are but slightly tipped with white, excepting the first, of which two inches are white, with a small brown mark at the end of the inner web, and a white spot near the end of the second quill. In another specimen, from the same Expedition, the first quill has a large spot of white near the end, beyond which a narrow bar of black, and the tip white; and there is a white spot on the inner web of the second near the end.

The name of *argentatus*, or *silvered*, signifying a dark colour, with a superficial tinge of white, cannot with any propriety be applied to this species; that of *argenteus*, or *silvery*, I have chosen, as nearly allied to the preceding in sound, and, although not by any means peculiarly applicable to this species, yet as sufferable as that of *marinus* applied to another species, and much for the same reason.

5. *Larus arcticus*. *Northern Gull*.

L. rostro inferne solum aucto, dorso alisque cœrulescenti-perlaceis, pennarum versus apicem spatio magno albo, prioribus quinque albescentibus, alis caudam æquantibus (tarso digitoque $2\frac{1}{4}$ pollicum longis).

Adult, Summer Plumage.—Beak moderate, deep, compressed, the upper outline without any prominence beyond the nostrils, upper mandible exceeding the under by about $\frac{5}{8}$ ths of an inch; wine-yellow, diaphanous at the tip and edges, an orpiment-orange spot at the knob; length $2\frac{1}{2}$ inches, depth $\frac{5}{4}$ ths. Feet pale flesh-colour; tarsus $2\frac{1}{2}$ inches, middle toe $2\frac{1}{3}$. Wings reaching exactly to the end of the tail. Total length $25\frac{1}{2}$ inches, extent 50. Back and upper surface of wings pure pearl-grey, with a good deal of blue; the outer primaries nearly all white, as well as their shafts, and the tips of all the quills. The rest of the plumage white.

Note.—The above description is from a fine specimen brought by Captain SCORESBY *junior*, from the coast of Greenland, in the autumn of 1822, and now in the Museum.

Adult, Winter Plumage, unknown, although from analogy it may be presumed to be distinguished from the summer only by longitudinal streaks of pale brown upon the head and neck.

Young.—There is a specimen in the Museum, which would seem to be the young of this bird; it is from Orkney, and its description is as follows:

Beak $1\frac{7}{8}$ in. long, $\frac{5}{8}$ ths deep, black at the end, dusky,

with yellow tints at the base. Tarsus $2\frac{3}{8}$ long, toe $2\frac{2}{8}$, yellowish, claws brownish-black. Wings a little longer than the tail. Total length 23 inches. The plumage is yellowish-grey, marked with longitudinal streaks of pale brown on the head and neck, transverse zigzags on the back and wings, partly substituted on the tail by irregular spots, and wanting on the first five quills, which are whitish. The under parts are a confused mixture of ash-grey with pale brown and yellowish-white.

Synonyms.—*Larus argentatus*, Captain Sabine, Memoir on the Birds of Greenland, Lin. Trans. vol. xii. pt. i. p. 546; Temm. Man. d'Orn. pt. ii. p. 764.

Remarks.—I can only refer to the above authors with certainty for synonyms. Mr EDMONDSTON, in the Memoirs of the Wernerian Society, vol. iv. p. 501, seems to describe the present species under the name of Iceland Gull, and, in fact, exhibited the bird supposed above to be the young of the first year, as the young of his bird; which, however, differs from mine, and TEMMINCK'S and SABINE'S Arctic varieties, as they consider them, of the Silvery Gull, in being much smaller in all its proportions. The specimen described above was considered by Mr SCORESBY as the true Burgomaster, and named so by him in his last publication; and it is more than probable that the present species is the Burgomaster of navigators, as well as the *Larus glaucus* of FABRICIUS, LATHAM, and others. For a fuller discussion of this point, I refer to the remarks upon the following species.

Distinctive Characters.—In point of size, as well as in regard to proportions, this species is nearly allied to the preceding, insomuch that it has been considered by TEM-

MINCK as merely an Arctic variety of it. It differs, however, in the following particulars. The bill has little or no protuberance above, which the *L. argenteus* has, although in a slighter degree; in *L. argenteus*, the upper mandible is very little longer than the under, in *L. arcticus* it is considerably; the nostrils are linear in the former, in the latter much wider, and almost pyriform; the wings are longer than the tail in *argenteus*, of equal length in *arcticus*; in the former, the five first primaries are more or less brownish-black, as well as the shafts, the tips abruptly white; in the latter they are whitish, the bluish colour of the base decreasing gradually, so that a large portion of the tips is pure white, as well as the shafts. There is a much more striking affinity between the present and following species, than between it and the preceding: the distinguishing characters will be pointed out in the next article.

The young of this species are distinguished from those of the following, chiefly by their great inferiority in point of size; they are distinguished from those of all the other great gulls by having no black on the quills or tail, by the greater lightness of the tints and markings, which agree with those of the following species.

6. *Larus glacialis*. *Greenland Gull*.

L. rostro inferne solum aucto, dorso alisque cœrulescenti-perlaceis, pennarum versus apicem spatio magno albo, prioribus quinque albescentibus, alis caudâ brevioribus (tarso digitoque 3 pollicum longis).

Adult, Winter Plumage.—Beak longish, less compressed than in the preceding species, without gibbosity above, wine-yellow, diaphanous at the tip and edges, an orpiment-

orange spot at the protuberance of the lower mandible; length 3 inches, depth $\frac{7}{8}$ ths. Iris pale yellow, angle of the mouth bright red, circle of the eyes straw-yellow. Legs and feet livid flesh-colour, claws blackish-brown; tarsus 3 inches long, toe 3 inches. Total length 31 inches, extent 62. Wings about two inches shorter than the tail. Back and upper surface of wings pearl-grey, with a good deal of blue. Edge of the wing, a considerable portion of the first primaries, and the ends of all the other quills, white; shaft of first primary pure white, of the rest gradually tinged with ash. The rest of the plumage snow-white. Head and neck longitudinally streaked with very pale brown, being along the shaft near the end of the feather.

Note.—The dimensions of the above are from a specimen in the Museum. As this individual is not perfectly adult, having still some pale brown markings on the tail and lower neck, and being thus probably a bird of three years, I have rectified the description of the plumage by the examination of another specimen belonging to Mr THOMAS TORRIE. Both these are from Shetland, and were shot, and presented by Mr EDMONDSTON. The dimensions of this latter specimen are, beak $2\frac{6}{8}$ inches long, $\frac{7}{8}$ ths deep; tarsus $2\frac{3}{4}$, toe $2\frac{3}{4}$; total length 28 inches.

Adult, Summer Plumage.—According to Capt. SABINE, whose description agrees with the above, the head and neck are pure white.

Young. Beak horn-colour to the fore parts of the nostril, the rest brownish-black, length $2\frac{5}{8}$, depth $\frac{9}{8}$ ths. (Feet flesh-colour,) claws lightish-brown; tarsus $2\frac{7}{8}$, toe $2\frac{7}{8}$. Total length 30 inches, extent 60. The general ground-colour of the plumage is pale ash-grey, with a little brown and yellow. Head and neck marked with longitudinal streaks of very

pale brown, each of the feathers being of this colour along the shaft near the end. Upper surface in general marked with transverse irregular zigzags of pale brown, deepening toward the tail, each feather being marked with several alternate bands of whitish tinged with ash and yellow, and of pale brown, the tip whitish-yellow. On the tail the bars are partially substituted by irregular spots. Primary quills irregularly marked with small spots. Under surface confusedly mottled with very pale brown, tinged with ash-grey and yellowish-white.

Note.—The above description is made up from a comparison of three different specimens, two of which are in the Museum, and the third is from the last Expedition under Captain PARRY. The two first are British specimens, one of them from Shetland, the other supposed to be from Orkney. In another specimen, also from Shetland, in the possession of Mr THOMAS TORRIE, to whom it was presented by Mr EDMONDSTON, the dimensions and tints were as follows :

Beak $2\frac{6}{8}$ long, $\frac{7}{8}$ ths deep; tarsus $2\frac{7}{8}$, toe $2\frac{7}{8}$; length 31, extent 63. In this specimen there is a greater predominance of ash-grey in the tints of the plumage, the inner webs of the quills are nearly pure pearl-grey, and the outer webs of the four first primaries are nearly free of spots. Beak wine-yellow along the edges, tinged with dusky above and below, and brownish-black toward the end.

It is not known whether the above descriptions of the young birds, be of the first or second winter plumage, although from analogy they might be supposed to be of the second, on account of the large proportion of light colour on the beak.

Manners and food.—The only account we have of the manners of this species is that given by Mr EDMONDSTON

of Shetland, in two papers in the fourth volume of the Memoirs of the Wernerian Society of Edinburgh, where he describes it under the name of Iceland Gull. According to his account, it only makes its appearance among the Shetland Isles in winter, coming, as he supposes, from the Arctic regions, about the middle of autumn, and departing toward the end of spring. Its favourite resorts are the entrances of the more exposed bays, or the ocean, a few miles off the land. It is greedy and voracious to a proverb, and seems peculiarly fond of carrion, occasionally entering the bays in quest of it. In its usual deportment it exhibits little of the characteristic vivacity of the smaller species, (a remark which is equally applicable to the *L. marinus*); and does not hover about the sportsman, like them, when shot at, but, when once alarmed, commonly flies off: Mr EDMONDSTON as above.—Its food consists of fish, carrion of all sorts, and young birds: one specimen, Capt. SABINE says, disgorged a little auk when shot, and on dissection another was found in the stomach.

Country.—According to Captain SABINE, they were found very common throughout Davis' Straits and Baffin's Bay, by the Expedition under Captain Ross, in 1818. According to TEMMINCK, it inhabits the most northern countries in general, but in greater numbers toward the east; said to be very common in Russia. It appears in winter in the Shetland Islands, as above. It not being by any means certain that this is the *L. glaucus* of FABRICIUS, &c. little more can be said of its diffusion.

Distinctive Characters.—In a mature state, this species can only be confounded with the preceding, from which it differs chiefly in size, as may be seen by comparing the dimensions given in the descriptions. There is a striking

similarity, however, between the two, so great, indeed, that, at first sight, one might readily take them for the same species. The beak is of nearly the same form, being in both without protuberance on the upper mandible, which is considerably less curved than in any of the other large gulls. The principal points of difference are the following: The nostrils are much narrower than in *L. arcticus*, the whole habit more robust, the head and neck in particular proportionally larger, the bill more elongated, and the wings shorter. It is in the dimensions, however, that we are to look for the most decisive characters; the present bearing to the preceding species much the same relation in this respect that the Raven bears to the Carrion Crow. The young also can only be confounded with those of the preceding species, from which they differ chiefly in size, being much paler than those of any other large species, and without the dark quills and tail of the others.

Synonyms.—*Larus glaucus*, TEMMINCK, Man. d'Ornith. pt. ii. p. 757. *Iceland Gull*, Mr EDMONDSTON, in Memoirs of Wernerian Society, vol. iv. *L. glaucus*, Capt. SABINE, in Linn. Trans. vol. xii. pt. ii. p. 527.

These are the only synonyms to which I can refer with certainty. TEMMINCK and SABINE have thought proper to extend the list. I would remark, in general, of their synonyms, that we cannot be in the slightest degree certain that the authors whom they quote, did not describe the *L. arcticus*. FABRICIUS's account of his *L. glaucus*, for example, accords in all things with our *L. arcticus*; and it is very probable that LATHAM, by his Glaucous Gull, means it also, or has confounded the two; and it is plain that he had no distinct conception of it, from his remark regarding a bird with the primaries black at the end, and from his quoting BRISSON, who, in his *Larus cinereus*, has assuredly

described the summer plumage of *L. argenteus*. The Burgomaster of voyagers is probably more often the *arcticus* than the *glacialis*, and, in many cases, it may signify both. It is therefore a hopeless task to search for synonyms, and highly improper to apply the history of any Glaucous Gull of the older writers to the present species.

Remarks.—The first satisfactory account that we find of this interesting species, is that given in a Memoir on the Birds of Greenland, by Captain EDWARD SABINE, in which he enumerates the species observed by the Expedition under Captain Ross, in 1818. Linn. Trans. vol. xii. p. 527. He there describes it under the name of *Larus glaucus*, Glaucous Gull, observing that it is unquestionably the Burgomaster Gull of the Dutch. This description is sufficiently accurate and circumstantial to remove all doubt with regard to the species. He observes, that from specimens in his brother's possession, he is enabled to render the history of the plumage complete, and, at the same time, to add it to the British Fauna; from which we have to infer that one or more specimens in Mr SABINE'S collection are from Shetland or Orkney. This part of the volume was published in 1818.

The very celebrated TEMMINCK, in the second edition of his *Manuel d'Ornithologie*, published in 1820, gives a full account of the species, under the name of *Larus glaucus*, describing it with his usual accuracy and precision, but only in its summer plumage. The length he says is 26 inches, while he also remarks that it is the largest of all the gulls known, yet the length of the *L. marinus* he states at from 26 to 27 inches. Of all the specimens which I have seen, two of which are adult, and four young, there is none so small as this.

A full account of the bird in a mature and young state,

in winter plumage, was afterwards given in the fourth volume of the Memoirs of the Wernerian Society, by Mr EDMONDSTON, a zealous ornithologist of Shetland. Mr E. has two papers on the subject, the first read on the 24th March 1821, the other on the 23d March 1822. His description is fuller than Captain SABINE'S, and he also describes its manners as observed in Shetland. In the first memoir, he introduces it as a new species; and in the last remarks definitively, that although it might have previously been obscurely known, it was now for the first time described as a British species; and from the circumstances detailed, it may with propriety receive the name of *Larus Islandicus*, which he had proposed, as both designative of its "Arctic haunts," and commemorative of the "vulgar appellation by which it is known in the Zetland Islands." This Part was published in 1822; but Mr EDMONDSTON alludes to a description made in 1814, which I have not been able to see.

It is still necessary to add a few words with regard to the names of this and the preceding species. It being understood that the Glaucous Gull of the older authors may signify either or both, it would be necessary to restrict the name of Glaucous to one of them, were its application indispensable. But this term Glaucous being equally applicable to three of the larger gulls, and a multitude of the smaller ones, and being, moreover, liable to lead into error, is it not better to adopt names free of all these faults? Of this kind, then, it is presumed, are the names proposed. With regard to the outcry against change of names, I have only to observe, that names, as well as descriptions, must continue to fluctuate until they be rendered of such a nature as to be harmonized with common sense and sound judgment.

XIV.—*Sketch of the Geographical Distribution of Plants in Yorkshire.*

By J. ATKINSON, Esq. F. L. S. &c. Leeds.

(*Read 31st May 1823.*)

THE county of York, situate in parallel 53° and 54° N., is not less distinguished for its size than for its varied surface, possessing almost every variety of soil to be found from the level of the sea to the altitude of 2368 feet. Its Flora consists of about 1400 species, of which upwards of 600 are Phænogamous, the remainder Cryptogamous. They may be arranged under the following Natural Orders.

Alismaceæ, - 15	Boragineæ, - 14	Chenopodeæ, 13
Apocynæ, - 2	Capparides, - 5	Cacti, - - - 4
Amaranthaceæ, 2	Cisti, - - - 1	Caryophylleæ, 37
Amentaceæ, - 31	Cruciferae, - 34	Caprifoliæ, - 9
Amaryllideæ, 6	Cichoraceæ, - 24	Convolvulaceæ, 4
Aroideæ, - 6	Cynarocephalæ, 14	Campanulaceæ, 6
Asphodeleæ, 8	Corymbiferae, 40	Dipsaceæ, - 9
Aristolochiæ, 1	Cyperaceæ, - 34	Ericæ, - - 11
Acerae, - - 2	Cucurbitaceæ, 1	Euphorbiaceæ, 9
Berberides, - 1	Coniferae, - 1	Filices, - - 28

Gramineæ, - 65	Onagrariæ, - 7	Scrophularinæ, 24
Gentianeæ, - 9	Orobancheæ, - 3	Smilacææ, - 4
Geraniæ, - 14	Orchideæ, - 18	Saxifrageæ, - 12
Hypericinæ, - 8	Portulacææ, - 2	Sempervivæ, 13
Hydrocharideæ, 2	Pedicularæ, - 1	Salicariæ, - 2
Irideæ, - - 2	Papaveraceæ, - 8	Thymelææ, - 1
Junceæ, - - 7	Polygoneæ, - 12	Tiliacææ, - 1
Lentibulariæ, 11	Plantagineæ, - 5	Umbellifereæ, 36
Lycopodineæ, 5	Primulacææ, - 14	Violeæ, - - 8
Leguminosæ, 44	Plumbagineæ, 1	Verbenacææ, - 1
Labiataæ, - 47	Rhamnî, - - 3	Musci, - - 200
Malvaceæ, - 5	Rubiaceæ, - - 11	Lichenes, - 207
Melanthaceæ, 1	Rosaceæ, - - 40	Hepaticæ, - 24
Naiades, - 12	Ranunculaceæ, 28	Algæ, - - 100
Oleinaæ, - - 2	Solaneæ, - - 7	Fungi, - 290

May not the general type of the vegetation of a country be considered as indicative of its geology?—Were the *Ericæ* ever found upon Chalk or Limestone?—Are not the following species always found upon these? *Chlora perfoliata*, *Astragalus glycyphyllos* and *hypoglottis*, *Neottia spiralis*, *Orchis pyramidalis*, *Cistus helianthemum*, &c.? Is not *Arenaria verna* found on every lead-mine in England? Does not the *Pinguicula vulgaris*, *Vaccinium oxycoccus*, *Empetrum nigrum*, &c. indicate Sandstone? Where can we find a single rare plant on Alluvial soil?

Beginning at the Spurn, and following the coast of Yorkshire as far as Bridlington, and proceeding up the Humber to a little above Hull, including the whole of Holderness—the *vale* of York, and from South Cave to Selby, as well as part of the plain of Cleveland to the Tees, the whole country is composed of *Alluvial* soil: here the botany presents nothing peculiar, having the same plants as the Lowlands of other parts of England. We no sooner cross the

river Ouse, at Selby, than we approach an extensive *Magnesian Limestone* Formation, extending across the county, from Doncaster, Ferrybridge, Kippax, Thorparch, Knaresbro' by Rippon, to the county of Durham: this district is rich in botany. At Kippax may be found, in about a square mile, *Orchis morio*, *mascula*, *ustulata*, *militaris*, *pyramidalis*, *maculata*, *conopsea*; *Habenaria viridis*; *Ophrys apifera*, *muscifera*; *Neottia spiralis*; *Listera ovata*; *Allium arenarium*, *oleraceum*; *Anthyllis vulneraria*; *Astragalus glycyphyllos*, *hypoglottis*; *Carlina vulgaris*; *Cerastium arvense*; *Chironia centaureum*; *Chlora perfoliata*; *Cistus helianthemum*; *Colchicum autumnale*; *Daphne laureola*; *Erigeron acre*; *Galeopsis versicolor*; *Gentiana amarella*; *Hedysarum onobrychis*; *Ornithogalum umbellatum*; *Potentilla verna*; *Rhamnus catharticus*; *Sanguisorba officinalis*; *Sedum telephium*; *Pimpinella magna*; *Antirrhinum minus*; *Circæa lutetiana*; *Campanula glomerata*, *latifolia*; *Caucalis daucoides*; *Parnassia palustris*, &c. &c. Throughout the whole of this district, most of the above plants are to be found more or less abundant. At Thorparch, a few rare ones may be added; such as, *Anemone pulsatilla*; *Silene noctiflora*; *Galium tricornis*; *Asperula cynanchica*; *Narcissus biflorus*; *Pyrus aria*; *Epipactis nidus avis*; *Actæa spicata*; *Melica nutans*; *Chichorium intybus*; *Carduus eriophorus*; *Atropa belladonna*; *Ophrys aranifera*? and *apifera*; *Ornithogalum luteum*, &c. &c. About Knaresbro', *Chara flexilis*, *hispida*; *Dipsacus pilosus*; *Geranium sanguineum*; *Lepidium latifolium*; *Silene nutans*; *Helleborus viridis*, &c. Passing over this limestone, which may extend about 10 miles in breadth, from Selby, we approach Leeds; the immediate vicinity of which is all clay. A few plants, not very common, may be found towards Knostrop, near the river Aire, such as, *Sisymbrium sylvestris*; *Cardamine amara*; *Stellaria nemorum*, and *Hottonia palustris*.

Passing Leeds, to the north, the Sandstone Formation begins. (It contains, in the neighbourhood of Bramley, Woodhouse, Chapelton, &c. many organic remains of vegetables: we have noble specimens of the *Phytolithus verrucosus*, *parmatus*, *stellatus*, *striaticulmis*, *sulciculmis*, *cancellatus*, *imbricatus*, and *tessellatus*.) The Sandstone Formation occupies an extensive district, by Otley, as far as Greenhow Hill, where it meets the Compact Limestone: it then passes south, forming a range of alpine moors, by Ilkley, Keighley, and Halifax, to meet the range of the like formation dividing Yorkshire from Lancashire. Many of these heaths are of considerable elevation, as, Bardon Fell, 1663 feet; Draughton Moor, 1074 feet; Foxstone's Moor, 1513 feet; Otley Chevin, 921 feet; Cow Rock Rumbles Moor, 860 feet. The rarer plants are, *Botrychium lunaria*; *Osmunda regalis*; *Polypodium phegopteris*, *dryopteris*; *Aspidium oreopteris*, *aculeatum*, *lobatum*, *dilatatum*; *Asplenium viride*, *trichomanes*, *adiantum nigrum*, *ruta muraria*, *Blechnum boreale*, *Pteris crispa*, *Cyathea fragilis*, *Hymenophyllum Tunbridgense*, and 80 Musci, all near Halifax: *Veronica montana*, *Scandix odorata*, *Narcissus pseudo-Narcissus*, *Pyrola media* and *minor*, *Prunus padus*, *Rubus idæus*, *chamæmorus*; *Trollius europæus*, *Geranium pyrenaicum*, *Epipactis latifolia*, *Crocus nudiflorus*, &c.

The moors, in general, are clothed with the three species of heath: the *Empetrum nigrum*, *Vaccinium oxycoccos*, and *Vitis idæa*, are also common; the more elevated parts furnishing the *Rubus chamæmorus*, *saxatilis*, *Lycopodium clavatum*, selago, *alpinum*; and, at the highest part, *Arbutus uva ursi*.

Retracing our steps to Greenhow Hill, and proceeding north-west, we come to the mountain district of Craven, chiefly consisting of compact limestone. Here we are presented with many most magnificent scenes, equally pleasing

to the lover of landscape and to the botanist. The rocks at Gordale Scar and Malham Cove, rising several hundred feet perpendicular, are probably not to be equalled in England. The mountains are of great elevation: Ingleborough 2368 feet, Pennigent 2281 feet, Great Whernside 2309 feet, West Simon-Scat 1593 feet, Beamsley Rock 1310 feet, Spode Hill Bank 1223 feet, Sutton Crag 1161 feet. Many of the summits of the higher parts of these mountains are covered with sandstone, producing ling and other plants common on that soil. The undisturbed woods, particularly about Bolton Abbey, afford a rich harvest for the botanist. Here trees of great age, and immense magnitude, may be seen literally covered with a profusion of cryptogamous plants, resembling a garden in miniature; Lichens hang in festoons from the branches, whilst the bark is hidden from view by innumerable mosses, on which vegetate Hepaticæ and Filices. The plants upon or near Ingleborough are, *Rubus chamæmorus*, *Actæa spicata*, *Sedum villosum*, *Sesleria cœrulea*, *Poa glauca*, *Festuca vivipara*, *Primula farinosa*, *Polemonium cœruleum*, *Ophrys cordata*, *Serapias longifolia*, *Rhodiola rosea*, *Convallaria polygonatum*, *Saxifraga stellaris*, *oppositifolia*; *Thalictrum minus*, *Draba muralis*, *Thlaspi arvense*, *Cochlearia officinalis*, *Geranium sylvaticum*, *sanguineum*, *Gnaphalium dioicum*, *Solida virgo aurea* γ, *Serapias ensifolia*, and *rubra*. In the district are found, *Chara hispida*, *Galium boreale*, *Viola lutea*, *Gentiana campestris*, *Ornithogalum luteum*, *Convallaria multiflora*, *Epilobium alpinum*, *Polygonum viviparum*, *Saxifraga aizoides*, *hypnoides*, *Stellaria nemorum*, *Arenaria verna*, *Potentilla aurea*, *Geum rivale*, *Dryas octopetala*, *Actæa spicata*, *Thalictrum minus*, *majus*, *Trollius europæus*, *Draba incana*, *muralis*, *Thlaspi alpestre*, *Cochlearia officinalis*, *Cardamine impatiens*, *Turritis hirsuta*, *Geranium phæum*, *sylvaticum*, *sanguineum*, *Hieracium palu-*

dosum, *Hypochæris maculata*, *Carduus heterophyllus*, *Senecio sarracenicus*, *Satyrium albidum*, *Ophrys nidus avis*, *Cypripedium calceolus*, *Salix myrsinites*, herbacea, reticulata; *Taxus baccata*, *Osmunda lunaria*, *Lycopodium selaginoides*, *inundatum*, *alpinum*; *Asplenium viride*, *Scolopendrium ceterach*, *Pteris crispa*, *Hymenophyllum tunbridgense*, &c.

The high range of hills called the Yorkshire Wolds, beginning at the coast near Bridlington, is composed of chalk. This formation extends by Driffield, forming a bow betwixt Beverley and Pocklington to the Humber. In this part the *Ericæ* are not found. The only rare plants are a few common to limestone, viz. *Festuca pumilis*, bromoides, *Gentiana amarella* β , *Chlora perfoliata*, *Astragalus hypoglottis*. Passing the Vale of Pickering (lately rendered notorious by the fossil bones discovered in the Kirkdale Cave), we come to the Oölite, extending from Scarborough, by Kirkby Moorside, Hemsley, to meet the Alluvium near Easingwold; it then takes a turn to the east, and passes Malton, and we find on it the following plants: *Chara hispida*, *flexilis*, *Veronica montana*, *Utricularia minor*, *Schænus mariscus*, *albus*, *Scirpus pauciflorus*, *acicularis*, *sylvaticus*, *Bromus pinnatus*, *Arundo epigejos*, *calamagrostis*, *Lolium arvense*, *Elymus europæus*, *Galium tricornè*, *Potamogeton gramineum*, *Viola hirta*, *lutea*, *Gentiana pneumonanthe*, *Bupleurum rotundifolium*, *Caucalis daucoides*, *Pimpinella magna*, *Linum perenne*, *Drosera Anglica*, *longifolia*, *Paris quadrifolia*, *Pyrola rotundifolia*, *Potentilla verna*, *Geum rivale*, *Papaver hybridum*, *Ranunculus lingua*, *parviflorus*, &c.

The only district which I have not been able to examine is the Alum-shale, rising on the coast, from Whitby to the Tees, including the Vale of Esk. The small line of Basalt found in Yorkshire, passes through the above.

Plants found in the southern counties of England, which are not in Yorkshire :

<i>Clematis vitalba.</i>	<i>Campanula patula.</i>
<i>Orobanche minor.</i>	<i>trachelium.</i>
<i>Tamarix Gallica.</i>	

Northern plants, not found :

<i>Ligusticum scoticum.</i>	<i>Aira levigata.</i>
<i>Cerastium tetrandrum.</i>	<i>Sagina maritima.</i>

Plants which appear to have reached their northern limits :

<i>Butomus umbellatus.</i>	<i>Viscum album.</i>
----------------------------	----------------------

Plants which appear to have reached their southern limits :

Trientalis europæa.

Native Swiss plants, found in Yorkshire :

<i>Malaxis paludosa.</i>	<i>Impatiens noli tangere.</i>
<i>Cistus marifolius.</i>	<i>Arenaria verna.</i>
<i>Geum rivale.</i>	<i>Campanula latifolia.</i>
<i>Ribes petreum.</i>	<i>Thlaspi alpestre.</i>
<i>Thalictrum majus.</i>	<i>Solidago virgaurea.</i>
<i>Sedum villosum.</i>	<i>Ornithogalum luteum.</i>
<i>Epilobium alpinum.</i>	<i>Melica nutans.</i>
<i>Pyrus aria.</i>	<i>Sedum Telephium.</i>
<i>Pyrola rotundifolia.</i>	<i>Allium arenarium.</i>
<i>minor.</i>	<i>Convallaria majalis.</i>
<i>Stellaria nemorum.</i>	<i>Fumaria claviculata.</i>
<i>Geranium lucidum.</i>	<i>Thalictrum minus.</i>
<i>sanguineum.</i>	<i>Astragalus hypoglottis.</i>
<i>Gentiana pneumonanthe.</i>	<i>Lepidium latifolium.</i>
<i>Osmunda regalis.</i>	

Rare plants, natives of Lapland and Yorkshire :

<i>Rubus chamæmorus.</i>	<i>Salix rosmarinifolia.</i>
<i>Draba incana.</i>	<i>Thalictrum alpinum.</i>
<i>Rhodiola rosea.</i>	<i>Andromeda polifolia.</i>
<i>Tofieldia palustris.</i>	

Rare plants, natives of Switzerland and Yorkshire :

<i>Cerastium alpinum.</i>	<i>Serratula alpina.</i>
<i>Potentilla aurea.</i>	<i>Dryas octopetala.</i>
<i>Bartsia alpina.</i>	<i>Aspidium lonchitis.</i>
<i>Gentiana verna.</i>	<i>Polygonum viviparum.</i>
<i>Viola lutea.</i>	<i>Saxifraga stellaris.</i>
<i>Salix herbacea.</i>	<i>aizoides.</i>
<i>Galium boreale.</i>	<i>Equisetum hyemale.</i>
<i>Lathræa squamaria.</i>	<i>Scandix odorata.</i>
<i>Rubus idæus.</i>	<i>Ribes alpinum.</i>
<i>saxatilis.</i>	<i>Asplenium viride.</i>
<i>Trientalis europæa.</i>	<i>Circæa alpina.</i>
<i>Salix pentandra.</i>	<i>Epilobium angustifolium.</i>
<i>Ophrys cordata.</i>	<i>Narthecium ossifragum.</i>

Rare plants, natives of Lapland, Switzerland, and Yorkshire :

<i>Papaver cambricum.</i>	<i>Asplenium adiantum ni-</i>
<i>Salix crowana.</i>	<i>gram.</i>
<i>Alisma natans.</i>	<i>Hymenophyllum tunbrid-</i>
<i>Scolopendrium ceterach.</i>	<i>gense,</i>
<i>Bartramia arcuata.</i>	<i>&c.</i>

Plants indicative of great altitude :

<i>Arbutus uva ursi,</i>	
Hutchin Moor, near Todmorden,	Yorkshire.
Cronkley Fell,	Do.
Kinder Scout,	Derbyshire.

- Dale Head, Westmoreland.
 Near Hexham, Northumberland.
 Martindale, Dale Head, Cumberland.

Saxifraga oppositifolia,

- Ingleborough, Hinklehaugh, and
 Malham Cove, Yorkshire.
 Cader Idris, and other high moun-
 tains in Wales.
 In a ravine of the Screes, near
 Wastwater, Cumberland.

Rubus chamæmorus,

- Ingleborough, Hinklehaugh, Kirby
 Fell, &c. Yorkshire.
 Mountains of Wales, Westmoreland, Cumberland,
 and Durham.

Plants extremely local.

Dryas octopetala—On Arncliffe, Clowder, in Littendale; and near Settle, Yorkshire; and Cronkley Fell*.

Gentiana verna—Found in Teesdale in most surprising quantities, and, luckily, cannot be extirpated, in consequence of its sending out innumerable runners, each of which becomes a plant on digging up specimens. Gardeners from all parts of England have visited this spot, and attempted its destruction, after removing quantities for sale. Goths indeed!

Cypripedium Calceolus—In several parts of Craven, Yorkshire; Castle Eden Dean, Durham; Borough Hall Park, Lancashire.

* Cronkley Fell is often cited as in Durham, but certainly on the York side of the Tees.

The Ladies' Slipper used to be found in tolerable plenty about Ingleborough; the greediness of florists has, however, rendered it scarce. The great secret in its cultivation appears to be rest. A poor man, in Craven, has made a considerable sum annually by the sale of this plant: he possesses a small garden surrounded with gooseberry trees; in the centre, he planted some years ago some plants of the *Cypripedium calceolus*; they were left undisturbed for a long period, and have filled the garden, flowering freely, and flourishing under the partial shade of the gooseberry-bushes.

LEEDS, }
 October 1823. }

XV.—*On a new British Species of Spatangus.*

By the Rev. JOHN FLEMING, D.D.

Minister of Flisk.

(*Read 21st March 1824.*)

THE portion of the animal which I am now about to describe, and which appears to constitute an addition to the British Fauna, has been in my possession nearly fourteen years. I formerly alluded to it in the "Contributions to the British Fauna," inserted in the second volume of the Memoirs of this Society, p. 247, as a species nearly allied to the common sort found on all parts of the coast. Indeed, I entertained some suspicions that it might prove only a variety; but having since examined many examples of the common species, and never perceived any approach by gradation to the characters which it exhibits, I can now with some degree of confidence announce it as distinct.

Spatangus ovatus. Groove between the mouth and vertex obsolete. Leske, ap. Klein Ech. p. 252, tab. xlix. f. 12. 13.—Only one specimen occurred in a fishing-boat from the deep sea cod-fishery, Zetland, 1809.—See Plate VI., lower figure.

DESC. Vertex nearly even. Oviducts approximate, with the punctured space behind. Vent transversely ovate. Enclosed space beneath cordiform, with single lateral pores. Primary spines supported on tubercles, with a central ligament, and surrounded by a moniliform ring. Spaces between the pairs of pores in the avenues rough. Colour purple. About an inch and a quarter in length.

I have adopted the appellation from LESKE with very considerable doubt. The Zetlandic species is more globular than expressed in LESKE's figure, and the line from the oviducts to the mouth is flat, instead of being carinate. In other respects, however, there is considerable general resemblance.

The following list contains all the species of Echini which are known to reside in our seas :

- I. Genus, CIDADIS.
 - 1. papillata.
- II. ——— ECHINUS.
 - 2. esculentus.
 - 3. miliaris.
 - 4. subangularis.
- III. ——— SCUTELLA.
 - 5. placenta.
- IV. ——— FIBULARIA.
 - 6. pusilla.
- V. ——— SPATANGUS.
 - 7. cordatus.
 - 8. ovatus.
 - 9. purpureus.

MEMOIRS

OF THE

WERNERIAN

NATURAL HISTORY SOCIETY,

FOR THE YEARS 1824-5.

V O L. V.

PART II.

WITH TEN ENGRAVINGS.

EDINBURGH:

ADAM BLACK, NORTH BRIDGE, EDINBURGH;

AND LONGMAN, REES, ORME, BROWN, & GREEN,

LONDON.

1826.

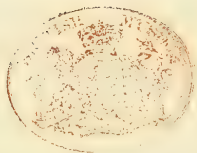

CONTENTS

OF

PART II. OF VOL. V.

	Page.
XVI.— <i>On some Fossil Shells found in the Garwilghur Range of Hills, in April 1823.</i> By H. W. Vasey, Esq. - - - - -	289
XVII.— <i>On the Geological Structure of the Hill of Seetabuldee, Nagpoor, and its immediate Vicinity.</i> By H. W. Vasey, Esq. - - - - -	298
XVIII.— <i>Description of Plumularia bullata, a new species, collected by the Arctic Expedition under Capt. Parry, in Hudson's Strait, 1821.</i> By the Rev. Dr Fleming. - - - - -	303
XIX.— <i>Commentary on the Herbarium Amboinense.</i> By Dr Hamilton. - - - - -	307
XX.— <i>On the Power possessed by the Spider of propelling its Threads, and on the Ascent of that Insect into the Atmosphere.</i> By John Murray, Esq. F. L. S. - - - - -	384
XXI.— <i>Observations on the Migrations, or occasional Migrations, of the Golden-crested Regulus, or Wren.</i> By J. P. Selby, Esq. - - - - -	397

	Page.
XXII.— <i>General Observations on Geology and Geognosy, and the Nature of these respective Studies.</i> By the Rev. Dr Grierson. - - -	401
XXIII.— <i>On the Mode of Growth, Reproduction, and Structure of the Poison-Fangs in Serpents.</i> By Dr Knox. - - -	411
XXIV.— <i>On the Superficial Strata of the Forth District.</i> By A. Blackadder, Esq. - - -	424
XXV.— <i>Notice regarding Fossil Bones of a Whale discovered in the District of Monteith.</i> By E. E. Drummond, Esq. - - -	440
XXVI.— <i>Tentamen Methodi Muscorum; or, A New Arrangement of the Genera of Mosses, with Characters, and Observations on their Distribution, History, and Structure.</i> By Dr Greville, and G. A. W. Arnott, Esq. - - -	442
XXVII.— <i>Notice in regard to the Trap Rocks in the Mountain Districts of the West and North-west of the Counties of York, Durham, Westmoreland, Cumberland, and Northumberland.</i> By Henry Witham, Esq. - - -	475
XXVIII.— <i>Description of Two New Species of Musci, belonging to the Genera Neckera and Hypnum.</i> By Dr Greville. - - -	481
XXIX.— <i>Account of the Method of Drawing Crystals in True Perspective, followed in the Treatise on Mineralogy of Professor Mohs.</i> By W. Haidinger, Esq. - - -	485
XXX.— <i>Account of some Fishes observed during Capt. Franklin and Dr Richardson's Journey to the Polar Sea.</i> By Dr Richardson. - - -	509

CONTENTS.

v

Page.

XXXI.— <i>Observations on the Habits, Appearance, and Anatomical Structure of the Bird named The Trumpeter, Psophia crepitans of Linnæus, Agami of Cuvier.</i> By Dr Trail.	523
XXXII.— <i>Memoir on the Classification and Division of Gnaphalium and Xeranthemum of Linnæus.</i> By Mr David Don.	533



APPENDIX.

<i>History of the Society,</i>	565
<i>List of Office-Bearers for 1826,</i>	580
<i>List of Members, continued from Vol. IV.</i>	581
<i>Index,</i>	585

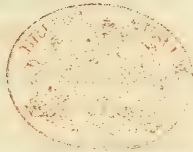

List of Engravings in Part II. of Vol. V.

- PLATE VIII. Sketches of Fossil Shells found in the Gawilghur Range of Hills, East Indies; described at p. 297.
- IX. Representation of *Plumularia bullata*, natural size, and magnified; described at p. 308.
- X. Tooth of the Rattle-Snake in different stages of growth, and Cranium of the Coluber Naja; illustrative of Dr Knox's paper on the Poison-Fangs of Serpents; explained at p. 422.
- XI. Map of the River-district of the Forth from Borrowstounness to Gartmore, described at p. 425.
- XII. Sketches illustrative of the Alluvial Strata in the River-district of the Forth; explained at p. 429, *et seq.*
- XIII. Figures illustrative of Messrs Greville and Arnott's New Arrangement of the Genera of *Musci*. *Splachnum* described at p. 461; *Dissodon* at p. 469; *Tayloria* at p. 474.
- XIV. *Neckera Americana* and *Hypnum remotifolium*, described at p. 481.
- XV. XVI. Diagrams illustrative of Mr Haidinger's method of Drawing Crystals in true Perspective; see p. 485, *et seq.*
- XVII. Bronchial Tubes and Trachea of the Trumpeter; described at p. 529.

ADVERTISEMENT.

IN laying its Memoirs before the Public, this SOCIETY does not hold itself responsible for the facts or opinions which may be advanced on the various topics of Natural History that are discussed. These, accordingly, must be distinctly understood as resting entirely on the individual authority of the respective Writers who have favoured the Society with Communications.



XVI.—*On some Fossil Shells found in the Garwilghur Range of Hills, in April 1823.*

By H. W. VAYSEY, Esq.

Surgeon to the Trigonometrical Survey, East Indies.

(Communicated by Sir JAMES MACGRIGOR, President of Army Medical Board.)

(*Read 6th March 1824.*)

THIS remarkable range of hills is called by ARROWSMITH, in his last map, the Bindeh, or Bindachull Hills. The same name is, however, given to a lofty range of hills on the left bank of the Godavery, as it passes through Goudwana, and also to those near Gualior. I shall therefore distinguish them by the name of the Gawilghur Range, particularly as, after repeated inquiries, I have never been able to discover that they were so designated either by the inhabitants of those hills, or of the neighbouring plains. They take their rise at the confluence of the Poorna and Taptee rivers, and, running nearly E. and by N., terminate at short distances beyond the sources of the Taptee and Wurda. To the southward they are bounded by the valley of Berar, and to the north by the course of the Taptee. The length of the range is about 160 English miles, and average breadth from 20 to 25 miles.

On the south side, they rise abruptly from the extensive plain of Berar, the average height of which is 1000 feet above the level of the sea, and tower above it to the height of 2000 and 3000 feet. The descent to the bed of the Taptee is equally rapid, although the northern is less elevated than the southern side of the range. The outline of the land is generally flat, but much broken by ravines, and by groupes of flattened summits, and isolated conoidal frusta. The summits and the flat land are for the most part remarkably destitute of trees, but they are thickly covered with long grass. In the ravines and passes of the mountains the forest is very thick, and in many places almost impervious. The inhabitants are principally Goauds, whose language, manners and customs, differ remarkably from those of the Hindoos. At present their chief occupation is hunting, and cultivating small patches of land, which produce a coarse rice and millet. In former years the cultivation must have been very extensive, since there are the ruins of numerous hill-forts and villages, which derived their chief subsistence from the surrounding lands. Many opportunities are afforded of studying the nature of this mountainous range in the numerous ravines and precipitous descents which abound in every part. A Wernerian would not hesitate in pronouncing them to be of the newest floetz trap formation; a Huttonian would call them overlying rocks; and a modern geologist would pronounce that they owed their origin to submarine volcanoes.

I shall not give them any other name than the general one of Trap-rocks, but proceed to describe them, and state, with diffidence, the inferences which I think obviously present themselves, on an attentive study of their phenomena.

1. The principal part of the whole range is formed of compact basalt, very much resembling that of the Giant's Causeway. It is found columnar in many places; and at

Gawilghur it appears stratified, the summits of several ravines presenting a continued stratum of many thousand yards in length.

2. The basalt frequently and suddenly changes into a wacke of all degrees of induration, and I may say of every variety of composition usually found among trap-rocks. It changes,

3. Into a rock, which may be named indifferently Nodular Wacke or Nodular Basalt, composed of nuclei of basalt, usually of great specific gravity, surrounded by concentric layers of a loose earthy mass resembling wacke, but without cohesion, which, on a superficial view, conveys to the mind every idea of a fluid mass of earth, having in its descent from some higher spot involved in its course all the rounded masses it encountered, and subsequently became consolidated by drying. A very slight inspection is sufficient to detect the true cause of this appearance, which is owing to the facility of decomposition of the outer crust, depending on difference of structure and composition. In none of the conglomerates or puddingstones do we observe any traces of this structure; and as it is common to the most crystalline greenstone, porphyritic greenstone, and those rocks usually denominated syenitic, there can be little doubt that it is owing to the development of a peculiar concretionary structure by decomposition.

In a small ravine, near the village of Saulminda, 2000 feet above the sea, I saw basalt of a perfectly columnar structure, and vertical, closely connected with a columnar mass, formed of concentric lamellæ, enclosing a heavy and hard nucleus. Perhaps these last were the ends of columns lying in a horizontal position.

Near this ravine I had also an opportunity of observing the gradual and perfect passage of the columnar basalt into that which has been called Stratified, from the parallelism

of its planes, the composition being identical, and, without doubt, contemporaneous. These changes and passages of one rock into the other, are so frequent and various, as to render it difficult to refer the most of them to either of the rocks I have above mentioned as types. I shall therefore proceed to describe those which are distinctly marked, and their accompanying minerals. In external appearance, the columnar and semi-columnar basalt closely resembles that of the Giant's Causeway, possessing the same fracture, internal dark colour, and external brown crust. It is equally compact and sonorous. It, however, contains more frequently crystals of olivine, of basaltic hornblende, and of carbonate of lime. The fusibility of each is the same. Perhaps the basalt of the Gawilghur Range more nearly resembles in every respect that of the Pouce Mountain in the Mauritius. This is, however, of very little importance, since every body who has travelled much in trap countries, knows well what great changes in composition and structure occur even in continuous masses. Among the minerals, calcedony and the different species of zeolite, are rarely found in the columnar basalt, but they are of frequent occurrence in that which is semicolumnar.

The wacke or indurated clay is as various in character and composition as the basalt, and, unfortunately, I have no type with which to compare it, as in the case of the basalt of the Giant's Causeway. Its colour varies with its constituents, but is most usually grey. It is easily frangible, very frequently friable, and is almost always porous and amygdaloidal. It appears to be composed of earthy felspar and hornblende, with a considerable proportion of oxide of iron. It is always easily fusible into a black scoria or glass, according with the quantity of zeolite which it contains. Of all the trap rocks it abounds the most in simple minerals.

They are Quartz and Amethyst-quartz.

Calcedony, and Calcedonic Agates, inclosing crystals of carbonate of lime.

Cachalong.

Common Opal and Semi-Opal.

Heliotrope.

Plasma, or transparent Heliotrope.

Stilbite.

Analcime.

Natrolite.

Ichthyophthalmite.

Felspar.

Carbonate of lime and Green-earth.

I have never been able to discover in it either augite or hornblende in distinct crystals. When the surface of the land is strewed with these minerals, it is a certain indication that the rock beneath is wacke. With regard to the situation of this rock, I think I have rarely seen it on the summits of hills, but much more frequently at their bases, and forming flat elevated plains. I shall have occasion to advert to this rock again when I proceed to describe the fossil shells.

The nodular basalt is perhaps the most common form of trap in this mountain-range, as well as in other parts of India. It more commonly forms the surface than either of the other rocks, and is as frequently seen on the summits as it is at the bases of the mountains. It rarely abounds in minerals of any kind. It is the principal source of the rich black diluvial soil, commonly called "Black cotton soil" of India. I have little to add to the former description of it. Its internal structure is sometimes beautifully developed by decomposition, since, in a mass of about six inches diameter it is possible to count above twelve concentric layers,

and, on striking the nucleus a slight blow with a hammer, one or two more layers are broken off. It is owing to this facility of decomposition that the annual rains carry down such vast quantities of alluvial soil from its surface, which is, moreover, always strewed with an abundance of nuclei, in various stages of decomposition. It is owing to the difficulty with which the roots of trees penetrate this rock, that they are so rare on its surface, and never grow to any size. Yet this circumstance does not prevent the *Andropogon contortum* and *nardus* from growing in the most luxuriant manner, which sufficiently proves the fertility of the soil.

On ascending from the Taptee (in April 1823), I observed in a *nullah* a group of basaltic columns, one of which was two feet in diameter, and six-sided. When near the summit of the flat table-land of Jillar, I entered a pass, formed on one side by a perpendicular section of the rock from 25 to 30 feet, and on the other by a rapid descent of 40 or 50. The lower part of the section, as well as the pathway, is composed of the wacke or indurated clay of the kind before mentioned, of about 10 feet in thickness. Lying on it is a stratum of earthy clay, of different degrees of induration and purity, 20 yards in length, and about 2 feet in thickness, containing great numbers of entire and broken shells. This possesses all the characters of a stratum, since the horizontal fissures are parallel, and are prolonged, with a few interruptions, through the whole extent. The accompanying sketch (Plate VIII. bottom) will serve to give a tolerably correct idea of the mode in which the stratum appears to overlie the lower rock, and to have been depressed by that which is superincumbent. The upper rock consists of about 15 feet in thickness of the nodular basalt or wacke, the nuclei being of all sizes. The vertical fissures which are so remarkable in trap-rocks, are prolonged from both the upper and lower rocks into the shelly stratum, although



Fig. 1.

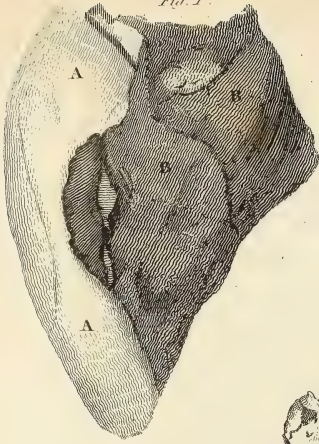

Fig. 2.

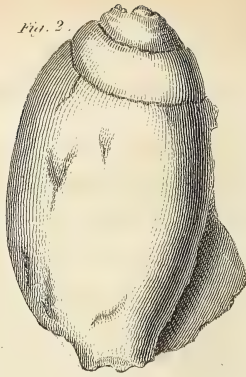

Fig. 3.

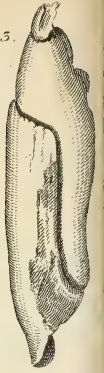

Fig. 4.

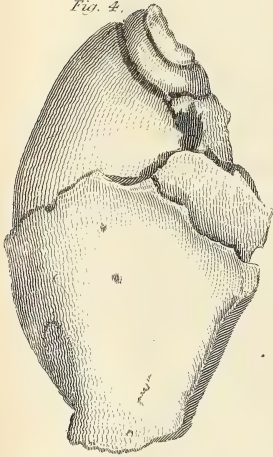

Fig. 6.



Fig. 7.



Fig. 5.

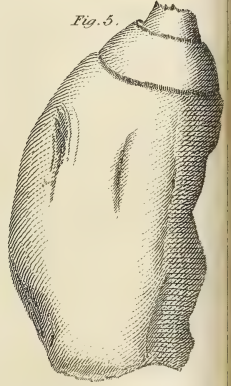
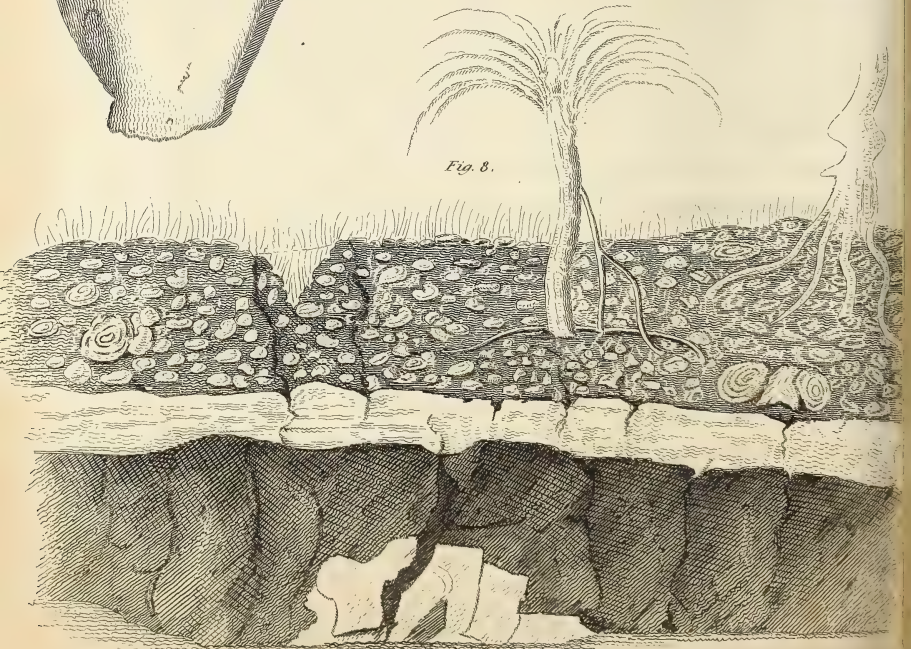

Fig. 8.



there is no intermixture of substance. The stratum is composed of a highly indurated clay, fusible before the blow-pipe, into a fine black glass; and neither it, nor the shells it contains, effervesce in acids. The shells are for the most part flattened, and belong either to the genus *Conus* or *Voluta*. It is not possible to conceive that so fragile a substance as a thin land-shell should have been so completely flattened, without fracture, unless it had been previously softened by some means, which, at the same time, produced a sufficient degree of pressure to effect its flattening.

I have attempted in the sketches of the shells (Plate VIII. fig. 3, 6, 7,) to give a representation of the degree of flattening, but I fear that it can only be well understood by examining the specimens themselves. Neither the rock nor its shells effervesce in acids. Westward, the ground is covered by the debris of a shelly conglomerate, much more indurated and impregnated with green-earth*. Some of the shells are entire, but these are rarely flattened. The matrix appears to be siliceous, and in some cases approaches to imperfect heliotrope. It is not fusible before the blow-pipe. I may here mention, that, in a report to the Marquis of Hastings, in June 1819, I mentioned the existence of shells in trap-rocks at Medcondah, at a height of 2000 feet above the sea. The hill was composed of nodular trap; and lying on its surface were numerous pieces of siliceous stone, containing shells of the genera *Turbo* and *Cyclostoma*. The specific gravity of the stone varied from 2 to 2.5. The shells did not effervesce in acids, although some of them preserve their external polish. Internally, some of the stones appeared to pass into flint, particularly those of small specific gravity, whilst their external surface effervesced in

* Exhibiting cavities and shells in relief. From the shape of the former, there can be no doubt of their having once contained shells

acids. Some of the small shells are completely changed into calcedony. Specimens of these shells are lodged with the Asiatic Society.

It is a remarkable fact, that the only remains of animals hitherto discovered in India, should be found in trap-rocks, and under such peculiar circumstances. *1mo*, They are found in situations where there are no indications of the former existence of lakes; *2do*, Both the shells and matrix are destitute of carbonic acid; *3tio*, The former are in many instances squeezed flat, without fracture, and in some cases commixed with their matrix.

These effects could only have been produced by the agency of heat, and consequently the modern theory of submarine or subaqueous volcanoes will best serve to explain the phenomena. These shells were deposited in the stratum of clay in which they are now found, and when forced up by the mass of wacke beneath, they were most probably at the same time covered by the nodular basalt. Thus we have heat to drive off the carbonic acid, and soften these shells, under a pressure which assisted the process, and at the same time flattened them.

I have numerous collateral proofs of the intrusion of the trap-rocks, in this district, amongst the gneiss, which do not allow me to doubt of their volcanic origin. I shall take an early opportunity of completing the history of the trap-rocks of India, for which I have been collecting materials for several years past.

HYDERABAD, }
 July 24. 1823. }

Explanation of Plate VIII.

Fig. 1. View of a shell much contorted by pressure, adhering to the matrix.

A A the shell.

B B the matrix.

2. Petrified shell.

3. Side-view of shell Fig. 2.

4. 5. Other petrified shells.

6. Side-view of Fig. 4.

7. Side-view of Fig. 5.

The sketch at the bottom of the plate represents the relative position of the beds of wacke, and clay containing the shells, and of overlying nodular trap.

A A Stratum of clay containing the fossil shells.

B B Bed of nodular trap.

C C Bed of wacke.

D D Trees of *Ficus Indica*.

E Surface of trap, covered with *Andropogon contortum* and *nardus*.

XVII. — *On the Geological Structure of the Hill of Seetabuldee, Nagpoor, and its immediate Vicinity.*

By H. W. VAYSEY, Esq.

Surgeon to the Trigonometrical Survey, East Indies.

(Communicated by Sir JAMES MACGRIGOR, President of Army Medical Board.)

(Read 6th March 1824.)

THE Hill of Seetabuldee, although agreeing in form and interior structure with other basaltic hills in its neighbourhood, merits a more particular description, on account of some peculiarities in the composition of the main rock, hitherto unnoticed by geologists, and for the opportunities afforded by its extensive quarries of studying the varied structure of the rocks of the Trap family, which is rarely to be seen in so distinct a manner.

The mass of the hill is composed of porous basalt, with a semi-columnar appearance, derived from numerous vertical fissures. It passes, at some places in a gradual, and at others in an abrupt manner, into a coarse porous wacke or indurated clay, which in its turn changes, in a similar manner, to the nodular basalt or wacke, of which the northern and southern summits of the hill are composed.

At the junction of these rocks, the passage is sometimes so gradual, as to give the intermediate rock an indeterminate character, partaking of the nature of both. At others, it is abrupt; yet, notwithstanding the abruptness of the change, the vertical and horizontal fissures are prolonged into each other, and cross the line of junction. I shall not here enter into a more minute detail of these appearances, but shall content myself with observing, that the most satisfactory explanation of these phenomena is derived from that theory which ascribes to the trap-rocks an igneous origin, under pressure of a great body of water.

The semi-columnar basalt, forming the greater part of the hill, is very porous, containing numerous amygdaloidal cavities, which are for the most part merely lined with a peculiar mineral, which I presume to name Conchoidal Augite. Sometimes, however, they are nearly filled with it, or with calcedony, semi-opal, or carbonate of lime; the calcedony being usually covered with a coating of green earth. The rock itself is composed of hornblende and felspar, with the augite so profusely disseminated, that it ought to be considered, in some cases, as a constituent of the rock. The rock is fusible, and is of considerable specific gravity, notwithstanding its porosity. The vertical and horizontal fissures are not always straight, but are at times waved; they are also sometimes lined with an infiltration of calcedony coated with clay and chlorite.

This rock is succeeded by an indurated clay or wacke, which, at its junction with the basalt, frequently partakes of its semi-columnar structure, the vertical fissures being prolonged into the wacke, and the schistose structure of the latter extending into the basalt. These changes may be very favourably seen in the fosse which surrounds the fortification.

The indurated clay or wacke seems to form but a small proportion of the hill, as it is not seen in the hollow between the greater and lesser elevation, the semi-columnar basalt being there uncovered by any rock. It also contains crystallised carbonate of lime and semi-opal, but calcedony coated with green earth is the most common mineral found in it.

This rock passes into the nodular wacke, which, on a casual inspection, appears to be a collection of stones rounded by attrition, and involved in a matrix of clay; when examined more carefully, it is evident that this appearance is owing to a peculiar modification of the concretionary structure, developed by decomposition. Nuclei, of various sizes, are enveloped by concentric lamellæ, which peel off, as decomposition destroys their cohesion. They are consequently seen in various states of decay, and of sizes varying from several feet in diameter to several inches. But their true nature is easily discovered by the mutual indentation of the different lamellæ which surround their respective nuclei, the centres from which this pseudo-crystallisation has proceeded. The existence of the vertical and waved fissures need scarcely be adduced as farther proof that they are not the product of alluvial detritus.

It appears most probable that they owe their forms to molecular magnetic attraction, since they contain a very large proportion of oxide of iron (nearly 25 per cent.), as may be perceived by the great specific gravity of hand specimens.

The nodular wacke or basalt is one of the most common forms of trap in the extensive districts composed of the rocks of this family south of the Nerbuddah.

It occurs perpetually in the extensive and lofty range of mountains situate between the Poorna and Taptee rivers, and appears to form their principal mass. It is found

equally abundant throughout the whole of Berar, part of the provinces of Hyderabad, Beeder, and Sholapoor, and appears to form the basis of the great western range of trap-hills which separate the Konkan from the interior of the Deccan.

It is probably one of the main sources, when decomposed, of the black diluvial soil, to which Hindostan owes so much of its fertility. The valley or extended plain of Berar, that of Hoshungabad, of Seronge, of Irundiala south of the Kistnah, of the Palnad bordering the Kistnah, and numerous others, all lie near the course of rivers, which at some former period have covered these plains, and formed their extensive deposits of alluvium. Whether the deposition originated in some sudden and partial inundation, or whether it was owing to the gradual subsidence of the waters of the great deluge, I think may be determined by cautious investigation. I am at present inclined to think that the most probable cause was the latter.

The hill of Seetabuldee offers favourable opportunities, if the quarries are extended, of ascertaining positively, whether the basalt is merely a superficial deposit, or is deeply connected with a mass beneath. It is surrounded on all sides by gneiss or slaty granite, which is found at the base of the hill a few feet deep. Perhaps Nagpoor affords more opportunities than any other part of India, of studying the geological history of these rocks, as it is situated near the junction of the primary and overlying rocks. Numerous opportunities must arise during the excavation of wells and baths, of ascertaining the connection of the strata beneath. A well, in Mr A. GORDON'S garden, near the base of the hill, of about 40 feet depth, penetrates through three or four feet of black soil, succeeded by a magnesian siliceous clay, which appears to owe its origin

to decomposition of the gneiss, by which it is immediately followed, and which continues to the bottom of the well.

From the summit of the hill of Seetabuldee, the difference in the outline of the rocks eastward is very perceptible.

The flattened summits, and long flat outline, with the numerous gaps of the trap-hills, are exchanged for the ridgy, peaked, sharp, outline of the primary rocks*. At Ramteak and its vicinity, the rocks are of granite and gneiss. At Doonguree, at Pullorah and Parsoonee, are found crystallised marbles passing into gneiss, capable of receiving a fine polish. "Foliated black manganese ore," in large quantity, is found here (JAMESON'S Mineralogy, third edition): some of the marbles contain a small quantity of magnesia. At Khoraree, a dolomite, or magnesian marble, is found, also in gneiss. At Nyakoond Pasonee, bed of the Pesh, granite and gneiss of various kinds, quartz-rock, and sandstone, occur.

P.S. I have lately had an opportunity of fusing a large piece of the Seetabuldee basalt in a steel-furnace. The product, after an hour's fusion, was a fine black opaque stone, resembling porous obsidian. Glass-bottles are commonly made in the Mediterranean from basalt, and that of Seetabuldee seems to be of an equally favourable nature for that purpose.

* Captain Bayley's plates of the battle of Seetabuldee give a very correct idea of the first outline of the basaltic trap-hills at Nagpoor.

NAGPOOR, }
 May 31. 1823. }

XVIII.—*Description of Plumularia bullata, a new Species, collected by the Arctic Expedition under Capt. PARRY, in Hudson's Strait, 1821.*

By the Rev. JOHN FLEMING, D.D. F.R.S.E.
M.W.S. &c.

(*Read 20th March 1824.*)

THIS coralline * is irregularly branched. Each branch arises from a cell (or denticle), which has enlarged into an ovate vesicle, slightly wrinkled across. From the top of this vesicle a tubular stem proceeds, thinly covered on one side with a row of cells, some of which are enlarged into vesicles supporting other branches. The base of the vesicle is united with the mouth of the cell, but the line of separation is distinct, in consequence of the cell (and branch with which it is connected) being of a denser substance. In the younger branches, the communication between the central tube of the stem and the cavity of the vesicle is free; in the older portions, however, this connection ceases. At the external base of the vesicle, from one to three tubular radicles take their rise, and descend along the supporting stem, and others which are inferior to it, closely adher-

* See Plate IX.

ing to the surface. These tubes are, like the stems and branches, destitute of joints. Each cell is short, scarcely the diameter of the stem which supports it, with a horizontal or slightly oblique mouth, and destitute of lateral or inferior processes. In all the cells I observed portions of a thin membrane connected or continuous with the margin, and more or less cup-shaped, which appeared to be the remains of vesicles, similar to those which give rise to the branches. Their nature was likewise pointed out by the remains of the tubular radicles still in connection with some of the largest portions. To some of the cells cylindrical bodies were attached, which, after maceration, appeared of the consistence of the body of the polypi of several Sertulariæ; but, instead of terminating in a tentacular head, became contracted, and gave rise to branches, bearing cells. In some cases, two contiguous cells supported each a vesicle bearing a branch.

The preceding description will suffice to shew, that this coralline differs from all those described by ELLIS, among his Vesiculated Corallines; by LAMARCK, in his genus Plumularia; or by LAMOUREUX, in his genus Aglaophenia. But the mutilated condition of the specimen leaves much to be desired in the characters of the species. I have observed in other vesiculated corallines* a capability, when placed in circumstances unfavourable for ordinary growth, of converting the polypi in the cells, into branches bearing cells. The anomalous appearances of this species seem to indicate that it had recently been placed in a condition where the exertion of similar energies was requisite in converting both polypi and ovaria into branches, thereby exhibiting a curious example of viviparous reproduction or extension.

* See Edin. Phil. Jour. vol. ii. p. 86.

The marine plants which were collected during the last Arctic Expedition under Captain PARRY, were consigned to the care of Dr HOOKER, for examination. There were a few zoophytes among them, which that distinguished botanist requested me to name. Though they were all found on the surface of the sea, about the middle of Hudson's Strait, 29th July 1821, they were, with few exceptions, such as ELLIS has described, as inhabitants of our own shores, differing, however, somewhat in habit. Among the Sertulariadae, one occurred which, from the preceding description, seems to be new, and the structure of which serves to throw considerable light on the physiology of the tribe. The drawing, which is now transmitted, will serve to exhibit the different stages of its growth. (Plate IX.)

Judging from the structure of the whole specimen, there seems to be ground for entertaining the belief, that each branch, in ordinary circumstances, takes its rise from an organ, which in many other species serves the purpose of an ovarium, and was termed by ELLIS a Vesicle. In this manner we can conceive each colony, the individuals of which are connected together either mechanically or organically, increasing to an indefinite size, and the common base acquiring proportional strength by the tubular radicles each new branch protrudes. But in what manner are new colonies formed? The specimen examined throws no light on this part of the history of the species; but analogy leads to the conclusion, that some of the vesicles may, at times, perform their function of ovoviviparous reproduction. The appearances exhibited by this coralline lead us to infer, that those "little regular arch-like risings," which ELLIS observed on his specimen of *Sertularia myriophyllum*, and which is common to the species, may be vesicles supporting branches similar to our species.

In the *Plumularia bullata* the bodies of the polypi them-

selves appear in progress towards the formation of branches. This curious circumstance may be accounted for, by taking into consideration the condition in which the specimen was found,—detached, and floating along with sea-weeds. It may have been brought from a considerable distance, and, in its new station, have suffered from several external agents. Hence it appears to have acted in a manner similar to what we have witnessed in the *Sertularia gelatinosa* of PALLAS,—by absorbing the tentacula of its polypi, and enlarging their bodies into branches.

These observations have been brought together, as serving to illustrate the organisation of the zoophytes, a subject which has been but imperfectly considered. The exterior covering of these animals is frequently, but erroneously, viewed as similar to the extravascular dwellings of the bee, or the subextravascular shells of the Mollusca; while, in its mode of growth, it is analogous to bone, a circumstance on which its *apparent* vegetating power depends.

Plate IX. Fig 1. Natural size.

2. A portion magnified.

MANSE OF FLISK, }
 March 12. 1824. }

Fig. 1.

Fig. 2.





XX.—*Commentary on the Herbarium Amboi-
nense.*

By FRANCIS HAMILTON, M. D.,

Fellow of the Royal Societies, and Societies of Antiquaries of London and
Edinburgh; of the Linnæan Society of London; and of the
Asiatic Society of Calcutta.

(Read 14th June 1823, &c.)

LIBER PRIMUS.

CAPUT I. II. III. & IV.

Palma indica major, p. 1, t. 1, 2, 3.

THIS is the best account that I have seen of what modern botanists call the *Cocos nucifera*. In the second chapter are enumerated thirteen species, which seem to be of the nature which botanists call Varieties, as arising in the kinds of plants that are much cultivated. The only one that may perhaps be a distinct species, seems to be the 12th, or Terri, (p. 12.); concerning which, however, I know nothing farther than what Rumphius states.

CAPUT V. & VI.

Pinanga domestica, p. 26.

This is the *Areca Catechu* of modern botanists, concerning which I may refer to my Commentary on the first part

of the "Hortus Malabaricus;" and I must remark, that Rumphius is as free as Rheede from the error of supposing that Catechu (*kath*) is made from this palm; and from this error the authors of the Encyclopedie (i. 240) are also exempt. Rumphius mentions four principal varieties, and several others of less note; but none of these seem to be what botanists call distinct species.

CAPUT VII.

Pinangæ sylvestres, p. 39.

The authors of the Encyclopedie first introduced these into the system of modern botany, and were followed by Willdenow; but I suspect that both followed Rumphius entirely, without having seen the plants; and that Willdenow, in forming the specific characters from the stipites, has not always understood the meaning of his author. I shall now enter into particulars, the different kinds enumerated by Rumphius being not mere varieties of cultivated plants, but distinct species.

Pinanga sylvestris globosa, p. 38, t. 5, f. 1, A.

This the authors of the Encyclopedie (i. 241) call *Areca spicata*, a name adopted also by Willdenow (Sp. Pl. iv, 595); but Gærtner (De Semin. i. 24, t. 9, f. 3) considers it as of a different genus, and calls it *Euterpe globosa*. I doubt much of the propriety of founding new genera of Palms merely from differences in the situation of the embryo, and suspect that the practice will lead to an arrangement altogether unnatural. Few palms are more different than the *Coryphas* and *Pinangæ sylvestres*, that have been united to form the genus *Euterpe* (Enc. Meth. Sup. ii. 623).

Pinanga sylvestris glandiformis prima, p. 38, t. 6.

In the *Encyclopedie* (i. 241), and by Willdenow (*Sp. Pl.* iv. 595), this is called *Areca glandiformis*.

Pinanga sylvestris glandiformis secunda, p. 39.

I think that in the Andaman Islands I have found this palm, the nuts of which were used, instead of the betel-nut, by the convicts confined on the island. I call it

Areca laxa foliolis binerviis, caudice incurvo, floribus triandris.

The following account I have extracted from notes taken on the spot.

Caudex sæpius incurvus, nunquam ut in *Catechu* strictus, pedes 20—30 altus, annulatus, inermis, apicem versus politus, viridis, tumidus.

Fronde cum impari pinnatæ. Pinnæ lanceolatæ, acutæ, integerrimæ, plicis quatuor binerviæ, e medio stipitis laterum superiorum enatæ, æquidistantes. Stipes inermis. Rachis triangularis, latere inferiore convexo.

Spatha nuda, monophylla, ex apice trunci annulati infra partem tumentem enata, lanceolata, acuta, extra convexa, intra concava, marginata, integerrima, decidua, interius dehiscens. Spadix decompositus, interne planus, nudus; externe convexus, ramosus. Rami angulati, ramosi. Ramuli hinc læves, inde denticulati.

Masculini flores plurimi, minuti, sessiles, bini singulis ramulorum denticulis insidentes. Calyx triphyllus, rigidus, foliolis lanceolatis, acutis, conniventibus. Filamenta vix ulla. Antheræ tres oblongæ. Pistilli rudimentum nullum.

Fœmininæ flores paucae, solitariæ, ad basin ramulorum ramis adnatæ, masculinis centies majores. Calyx triphyllus, convolutus foliolis ovatis, concavis. Petala tria viridia, ovata, acuminata, circa germen arcte convoluta, calyce longiora, ovata, concava. Germen obsolete trigonum, ovatum, acuminatum. Stylus nullus. Stigma acutum.

Pericarpium non vidi.

In the woods of Chatigang and Rangpur I found another Palm very nearly allied to this of Rumphius, and

which, in the former, was called Ram Gua, or Wild Betel-nut, while, in the latter, it was called Runi Supari. I sent plants to Dr Roxburgh, thinking it might be the *Areca alba*; but Dr Roxburgh was of a different opinion, and called it *Areca triandra*, a name not very appropriate, as applicable to several species.

Areca triandra pinnis lateralibus falcatis, acutis; terminali bifurca, præmorsa.

Areca triandra, Hort. Beng. 68.

Areca alba, Willd. Sp. Pl. iv. 596? Encyc. Meth. Sup. v. 441?

Ram Gua } Bengalensium.
Runi supari }

Habitat in sylvis Camrupæ et Tripuræ.

Caudex strictus, 12–20 pedes altus, annulatus, inermis; apice lævi, viridi, tumente. Stipites læves, longitudine fere frondis subteretes, basi dilatato amplexicaules. Rachis communis subanceps, supra carinata.

Fronde cum impari pinnatæ. Pinnæ sessiles, longitudinaliter decurrentes, integerrimæ, nudæ, ad nervos 6—12 plicatæ; laterales falcatæ, acutæ; terminalis bifurca lobis divergentibus, præmorsis.

Spatha ex apice caudicis annulati infra partem tumentem enata. Spadix ramosissimus, erectus.

Flores omnino ut in *A. laxa*, sed antheræ sagittatæ; stigma trilobum.

Bacca magnitudine amygdali oblonga, utrinque acumine obtuso terminata, glabra, pulpa molli rubra tenui tecta. Semen bacca conforme, integumento crasso lignoso fibroso tectum. Albumen absque cavitate ruminatum. Embryo in basi seminis positus, conicus.

Very nearly allied to this last is a small Palm, which I found near Goyalpara, and which is probably the *Areca gracilis* of the Hortus Bengalensis (68), as Dr Roxburgh received his plant from the neighbouring territory (Sylhet), and as the name is very applicable; but I did not observe the plant in the garden at Calcutta. I should have considered it as the same with the next plant described by Rumphius, on account of its *truncus gracilissimus et te-*

nuissimus (p. 41, § 2.); but its fruit is too large. I shall here content myself by giving a few notices concerning this palm.

Caudices aggregati, pollice vix crassiores, pedes 8 vel 9 longi.

Frondes omnino ut in *A. triandra*.

Flores non vidi.

Spicæ fructiferæ simplices, recurvatæ, angulatæ, undique aspersæ baccis calyci marcescenti insidentibus.

Bacca ovata utrinque acumine obtuso terminata, parva, glabra. Caro fibrosa, tenuis, undique semini adhærens. Semen ovale, fundo baccae absque funiculo umbilicali adhærens. Albumen ruminatum, nulla cavitate in medio insculptum. Embryo conicus, albidus, in basi seminis nidulans.

Pinanga sylvestris oryzæformis, p. 40, tab. 5, fig. 2,
et lit. B. C. & D.

The authors of the *Encyclopedie* (i. 241), and after them Willdenow (*Sp. Pl.* iv. 596), call this *Areca globulifera*; while Gærtner (*De Sem.* i. 19, t. 7, f. 2.) calls it *A. oryzæformis*, which seems the preferable name, being that first given.

Pinanga sylvestris Saleyt dicta, p. 41.

In modern systems this remains entirely unplaced.

Pinanga sylvestris saxatilis, p. 42, t. 7.

Willdenow calls this the *Areca humilis* (*Sp. Pl.* iv. 595.) Loureiro imagined that he had seen the plant in Cochin-China, and called it *Borassus caudata*, in which he is followed by the *Encyclopedie* (vi. 258); but then there is great reason to suspect that the plant which Loureiro saw is quite different from that of Rumphius, as the author of the *Encyclopedie*, copying from Loureiro, describes an undivided spadix, and three nuts in each fruit, while Rumphius represents the spadix as branched, and the fruit as resembling that of the *Pinanga oryzæformis*, which has

only one seed. The compiler of the Supplement to the Encyclopedie (i. 140), with his usual candour and judgment, has abandoned this plant of Loureiro, at least as being the same with the *Pinanga sylvestris saxatilis*, and adopts the name *Areca humilis* of Willdenow.

CAPUT VIII.

Saribus, p. 42, t. 8.

This is the *Corypha rotundifolia* of the Encyclopedie (ii. 131), and of Willdenow (Sp. Pl. ii. 201); but its belonging to the genus *Corypha* is extremely doubtful, and rests entirely on the comparison which Rumphius draws between it and the Codda Pana of the Hortus Malabricus, —“quæ quoad folia magnam cum Saribo nostra habet convenientiam—verum tantum differt, ut diversa sit habenda species,” (44). The Saribus is therefore as likely to be a Chamærops or Rhapsis, and still more likely to be a Licualia than a Corypha. I cannot, indeed, help wondering, that Gærtner (De Sem. i. 18) should have confounded it as a species with the Codda pana of the Hortus Malabaricus. This renders what he says concerning the fruit of the Corypha quite uncertain, as no one can tell whether he described the fruit of the Codda pana, or that of the Saribus; yet I suspect that most of the recent generic characters given of the Corypha are derived from this uncertain source.

Limalia arbor, p. 44, t. 9.

The authors of the Encyclopedie (ii. 201) called this at first the *Corypha licualia*, and it has perhaps as good a claim to remain in that genus as the Saribus; but Thunberg has made it a distinct genus; and it is now the *Licualia spinosa* of Willdenow (Sp. Pl. ii. 201), a name

adopted in the Supplement of the Encyclopedie (iii. 450), and by most recent botanists.

When in Chatigang, I observed a species very nearly allied to this, and sent specimens, and a description, to Sir Joseph Banks; and, on the 24th April 1798, I sent seeds to Dr Roxburgh. I have since found the same plant on the hills of the Rangpur district; and Dr Roxburgh procured it from his son, for the Botanical Garden of Calcutta, where it is called *Licualia peltata*. I annex a description taken from my Notes.

Licualia peltata stipite aculeato, frondi flabelliformi, staminibus distinctis.

Kurup et Kurkuti Bengalensium.

Habitat in montibus ultra Gangem.

Caudex 3—5 pedes altus, crassitie brachii humani curvus, teres, lævis, apicem versus stipitum rudimentis exasperatus, plerumque simplicissimus, sed aliquando vidi ramos paucos ut in Cycis.

Frondes 5 seu 6 confertissimæ, sparsæ, horizontales, peltatæ, subrotundæ, 8—12 partitæ laciniis cuneiformibus, ad latera integerrimis, apice præmorsis, nitidis, glabris, ad nervos longitudinaliter plicatis, pedem unum vel alterum longis. Stipes trigonus, longus, patens, imberbis, utrinque aculeis rectis horizontalibus validis armatus. Stipulæ retiformes, laceræ, basin stipitis investiunt.

Spadix erectus, foliis longior, interruptus articulis ad basin compressis lævibus, apicem versus incrassatis tomentosus. Spicæ simplices, teretes, ex apice singulorum articulorum solitariæ, secundæ, resupinatæ, pedem longæ, multifloræ. Pedunculus communis compressus, angulatus, tomentosus. Flores plurimi, sparsi, magnitudine florum hyacinthi. Spathæ vaginantes, læves, teretes, laxæ, basin articulorum spadicis singulorum tegentes, ore oblique-truncato, indefinite dentato.

Calyx monophyllus, subcylindricus, inferus, ore tridentato. Corolla monopetala, calyce duplo longior, persistens, trifida laciniis ovatis acutis patulis. Filamenta sex, ovata, acuta, plana, distincta. Antheræ sagittatæ, erectæ, corolla breviores. Germen oblongum, truncatum. Stylus subulatus, staminibus longior. Stigma simplex.

Bacca aurantii colore oblonga, basi attenuata, stigmatate coronata, unilocularis. Cuticula punctata. Caro succulenta, fibrosa,

undique semini adhærens. Semen unicum, grande, forma bacca leve. Integumentum duplex; exterius crustaceum, durum, tenue; interius membranaceum, utrumque arcissime adnatum. Albumen semini conforme, cartilagineum, cavitate obliqua, utrinque attenuata, apicem prope et basin seminis hinc inde attingente perforatum. Embryo ovalis, semini prope basin (cavitatis extremitati inferiori oppositus) immersus, utrinque obtusus, lacteus.

CAPUT IX.

Lontarus domestica, p. 45, t. 10.

Jussieu (Gen. Pl. 45) proposes to restore the name *Lontarus*, in place of *Borassus*, the name given by Linnæus, and since adopted by most botanists, but derived from the name of a part (spatha) common to most palms. The name *domestica* is well chosen, as I have never seen the palm except near villages; while *flabelliformis*, the specific name usually given since the time of Linnæus, is applicable to every species which can be considered nearly related to the same genus. I consider, therefore, that Gærtner was perfectly justifiable in having (De Sem. i. 21) restored to this palm the name *Lontarus domestica*. Indeed, it may be observed, that Linnæus very commonly changed the names given by Rumphius for the worse, and that the plan of making the generic name a substantive, agreeing with an adjective for a specific appellation, seems to have been borrowed from the venerable Dutch Governor, although Linnæus has generally received credit for the invention. No doubt, however, Linnæus followed the rule almost universally, while Rumphius only adopted it in a great proportion of instances.

CAPUT X.

Lontarus sylvestris, p. 53, t. 11.

In the Encyclopedie (ii. 131) this is considered as a species of *Corypha*, and has the barbarous specific name *utan*.

Dr Roxburgh (Hort. Beng. 25) adopted the same names, and is an excellent authority for placing it in the same genus with the *Corypha* described by Rheede, having examined the fructification of both palms.

Lontarus sylvestris Yhur dicta, p. 54.

This is evidently a palm, with leaves shaped like a fan, and which produces a sago; but to what genus it belongs, no one can say, from any thing that Rumphius states.

Lontarus sylvestris Cabang, p. 55.

This is a palm very nearly allied to the *Licualia peltata*, already described, but distinguishable by the smaller number of sections into which its leaves are divided. It serves, however, similar purposes, and probably belongs to the same genus.

CAPUT XI.

Lontarus sylvestris altera, p. 56, t. 12.

From the fruit containing three or four nuts, and from the general appearance of the plant, I consider it probable that this palm is a species of *Borassus* or *Lontarus*.

CAPUT XII. & XIII.

Palma indica vinaria secunda, p. 57, t. 13.

Burman, in his Commentary, considered this is a *Chamærops*; and the authors of the *Encyclopedie* (vi. 258), misled by Loureiro, looked upon it as a *Borassus*, which obtained the specific name *gomutus*. Both *Chamærops* and *Borassus* having fan-shaped leaves, while those of the palm in question are pinnated, these arrangements were quite unnatural, no circumstance in this natural order producing such a change of appearance as the form of leaf. Dr Roxburgh, accordingly, (Hort. Beng. 68), with great

propriety, considered this as not belonging to any Linnæan genus, and, adopting one of the names used by Rumphius, called it *Saguerus Rumphii*; which I think preferable to the name *Arenga* given to it by Labillardiere (*Enc. Meth. Supp. i. 441*), and probably derived from *Aren* of the Japanese.

Arbor Tsiang, p. 63.

This palm, Rumphius says, has an appearance intermediate between the *Saguerus* and *Saribus*, one having pinnated, and the other fan-shaped leaves. On this account, it may be perhaps considered as nearly allied to the *Levistonia* of Brown (*Nov. Holl. i. 267*).

CAPUT XIV.

Seguaster major, p. 64, t. 14.

This is usually quoted by botanists for the *Caryota urens*; but, in my Commentary on the First Part of the *Hortus Malabaricus*, I have expressed a doubt whether this be the same with the *Schunda pana*, and to that Commentary I must here refer.

CAPUT XV.

Seguaster minor, p. 67, t. 15.

I do not find that any modern botanist quotes this palm; and Burman in his Commentary seems quite wrong in considering it as a *Caryota*, as it has simply pinnated leaves. It is more probably an *Areca*, and seems in particular very nearly allied to the *Areca humilis* of Willdenow, which has been already mentioned in this Commentary. It would appear that each fruit has only one seed, otherwise, from the form of the leaves, I should have thought that it belonged to the same genus with what Dr Roxburgh (*Hort. Beng. 68*) called *Wrightia caryotoides*; and as the two

seeds of the *Wrightia* adhere closely, forming as it were one body, I am still inclined to think that this may be the case. I shall therefore give here some account of the *Wrightia* of Dr Roxburgh, as probably belonging to the same genus with the *Seguaster minor*. As another plant, however, has been called *Wrightia* by Mr Brown (Nov. Holl. i. 467), this palm should obtain another name. In the year 1798, I found it in Chatigang, but only in leaf, and sent specimens of these to Sir Joseph Banks. At the same time I sent roots to Dr Roxburgh, but it would appear that these did not succeed; and he afterwards procured plants from Mr Peirard. The name of this plant, as given to the last mentioned gentleman by the Bengalese, is *Chilpata*; but to me they called it *Harina*, a name I would propose for the genus. The fugitives from Aracan, or Rakhain, then in the district of Chatigang, called it *Mu-zha Ma-tan Raik*. I have since found the plant on the hills near Goyalpara.

Harina caryotoides.

Habitat in montibus Bengalæ orientalis.

Radix fibrosa. Caudex nulla. Stipites radicales, congesti, obsolete trigoni, erecti, læves, octo pedes longi, pollicem crassi, indivisi. Frondes 6—8 pedes longæ, cum impari pinnatæ. Pinnæ laterales inferiores sæpius hinc inde 2 vel 3 approximatae; superiores solitariae, alternæ, pedes 2 longæ, semipedem latae, ad basin cuneatae, integerrimæ, apicem versus truncatolobatae lobis apice præmorsis; terminalis flabelliformis, parva, præmorsa: omnes nervosæ, supra nitidæ, subtus albidæ. Rachis communis subtus rotundatus, supra canaliculatus. Stipulæ fibrosæ, reticulatæ stipites infra involunt.

Spadix cubitum longus, erectus, intrafoliaceus, spicas breves habet paucas, sparsas, erectas, rigidas. Rachis communis obtus angulus, squamulosus, foveis unifloris aspersus. Flores parvi, apice rubicundi; spicæ apicem versus masculini pauci, basin versus fœmininæ plurimæ.

M. Calyx crassus, subrotundus, truncatus, subtriphylus foliolis concavis, altero marginum exteriore imbricatis. Petala tria, calyce longiora, unguibus latis subcoalita. Stamina sex, corolla breviora.

F. Calyx et corolla ut in Masculino. Stamina abortives tria, petalis alterna. Germen magnum, ovatum, superum. Stylus nullus. Stigma emarginatum.

Bacca dura, sicca, ovata, bilocularis. Semina solitaria, magnitudine semen Coffeæ paulo exsuperantia, hinc plana, inde convexa, ovata. Albumen forma seminis. Embryo parvus, centripetus, in dorso seminis convexo nidulans.

Seguaster minor e qua latrones Sargilæ hastas formant, p. 68.

Whether this be a mere variety, or a different species, is uncertain; but the latter seems the most probable.

Seguaster minor forma foliorum et ramorum diversa, p. 68.

Rumphius says expressly, “una habenda est species cum seguastro minore;” yet, from the account which he gives, the difference seems very great.

CAPUT XVI.

Nypha, p. 69, t. 16.

This is the *Nipa fruticans* of Willdenow (iv. 597), and of the Encyclopedie (Sup. iv. 98). It is exceedingly common on the muddy banks of the Gangetic estuaries, from whence it is often washed away, and floats entire into the sea, where sailors mistake it for the Coco-nut palm.

CAPUT XVII. XVIII.

Sagus seu Palma farinaria, p. 72.

Rumphius first describes at great length the habit of this genus, which, after him, is now generally called Sagus, although an attempt has been made to call it Metroxylon; but this attempt has luckily proved abortive. Rumphius then proceeds to mention four kinds, which seem to be distinct species, although they all produce sago; but this, or

an analogous substance, is produced from the stem of several other palms.

Sagus genuina, p. 75, t. 17 & 18.

Dr Roxburgh (Hort. Beng. 68) called this *Sagus inermis*; but it is certainly the *Sagus Rumphii* of Willdenow (Sp. Pl. iv. 404). As it is from this that by far the greater part of sago, and that of the best quality, is prepared, I think that the name of Rumphius is by far the most appropriate. The author of the Supplement to the Encyclopedie (v. 13) doubts, whether this *Sagus genuina* be a different species from the *Sagus farinifera* of that work (vi. 394); but this doubt seems unnecessary, as the sago of the *Sagus farinifera* is the worst of all others. It is to the *Sagus genuina*, probably, that we should refer the *Arbor Zagoe Amboinensis* of Seba, which Burman (Hor. Ind. 240), and Willdenow (Sp. Pl. iv. 844), have referred to the *Cycas circinalis*; for I may venture to affirm, that sago never was procured from the stem of the *Todda pana* of the Hortus Malabaricus (iii. 9), although the nuts of this tree, when bruised, give a flour, that is used in Malabar as an aliment. This error, clearly pointed out by Rumphius (p. 92), seems to have arisen from Rheede's having mistaken his *Toddo pana*, one of the most common trees in Malabar, for the *Soteetsou* of Japan. It must farther be observed, that Rumphius, far from describing various kinds of the *Olus calappoides*, that produce sago, as the younger Burman asserts, describes the sago to be the produce of a totally different plant, as here mentioned; and it is to be lamented that the younger Burman did not attend to the excellent observation of his father on this subject, contained in this volume of Rumphius, p. 78.

Sagus sylvestris, p. 75.

This species has not been taken up by any author that I have seen.

Sagus longissima, p. 75.

This is the *Sagus farinifera* of Gærtner (De Sem.ii.186), and of the Encyclopedie (vi. 394), a name not so well chosen as that of Rumphius; for sago is not a farina, and, if it were, this species produces the worst sago of any enumerated by Rumphius. On this account, it is probably not the *Metroxylon sago* of Rottbol, who, according to the Hortus Kewensis (v. 281), meant the *Sagus genuina*.

Sagus lævis, p. 76.

This name Dr Roxburgh (Hort. Beng. 68) has changed to *Sagus spinosa*, an alteration not for the better, as all the four kinds mentioned by Rumphius are spinous. I do not find this plant taken up by any other recent author.

CAPUT XIX.

Sagus filaris, p. 84, t. 19.

This would seem to belong to a different genus from the four species of *Sagus* described by Rumphius in the two preceding chapters.

Bisula, p. 85.

A palm resembling the *Lontarus sylvestris* already mentioned, and therefore nearly allied to the *Corypha*, *Licualia*, and *Borassus*; but nothing is said to enable us to judge to which it is most nearly allied, except that its fruit, being compared to that of the *Pinanga* (*Areca*) or *Betel-nut*, probably contains only one nut, and it therefore should not be a *Borassus*.

CAPUT XX.

Olus calappoides, p. 86, t. 20, 21.

The younger Burman (Fl. Ind. 240) quotes the Olus *calappoides* (p. 86) for the *Cycas circinalis* of Linnæus, by which this great naturalist meant the *Palma farinifera Japonica*, *Setitsou Japonensibus* of Breynius (Fl. Zeyl. 393), as producing sago, although he quotes as synonymous the *Palma prunifera Japonica* of the Hortus Malabaricus (iii. 9, t. 13—21). Now, this quotation is erroneous; for, in the places referred to, Rheede describes the *Todda panna*, one of the most common productions of the coast of Malabar; and although he alleges that it also grows in Japan (p. 12), where its stem produces sago (p. 13), I have no doubt that this is an entire mistake, (see the Commentary on the *Sagus genuina*, and Buchanan's Mysore, ii. 469); for Thunberg refers the Tessio, or Sotits, of the Japanese, if that be the same with the Soteetsou, Setitsou, or Sotectsou, to the Tetsice of Rumphius, which will be afterwards mentioned.

But farther, the proper Olus *calappoides* of Rumphius, described in page 86, is not figured in the tables 22 and 23, as Burman would have it. The male plant is represented in tables 20 and 21, and Rumphius gives no figure of the female; but it is from the form of the female spadix chiefly, that the species of *Cycas* can best be determined. In the text, however (p. 87), Rumphius describes this very clearly,—“Extremum petioli, e quo fructus dependent, æmulator planum pueri manum seu cristam galli;” from whence we may probably conclude, that the Olus *calappoides* (p. 86, t. 20, 21) is nearly related to the *Cycas revoluta*, as described by Sir J. E. Smith, in the Linnæan Transactions (vi. 312, t. 29, 30); but this, it is admitted, is the Olus *calappoides sinensis* (p. 92, t. 24), which Rum-

phius clearly distinguishes from the *Olus calappoides*, as he also (p. 90) does the *Todda pana* of Rheede. If the figure of Rumphius could be depended on, we might readily distinguish these species, as it represents the stipites of the *Olus calappoides* as unarmed; but in the description (p. 86), he says, “Rami (stipites) a trunco usque ad foliorum ortum ad margines brevibus obsiti spinibus.”

On the hills which bound Bengal to the east, I have found the female of a *Cycas*, which may be the plant of Rumphius, and which I shall here describe.

Cycas pectinata stipitibus aculeatis; spadicibus fœmininis mucronatis, utrinque pectinatis.

Cycas angulata, Brown, Nov. Holl. i. 348. ?

Olus calappoides, Herb. Amb. i. 86, t. 20 et 21.

Ban Khejur Bengalensium.

Habitat in Camrupæ orientalis sylvis.

Truncus 7—10 pedes altus, subramosus, teres, annulatus.

Fronde in trunci apices confertæ, pinnatæ. Pinnæ æquidistantes, suboppositæ, decurrentes, lineares, acutæ, margine revoluta integerrimæ, avenes, uninerves junioribus tomentosissimis. Stipites ancipites, tomentosi, aculeis utrinque pectinati.

Flores dioici; in arbore fœminina capitulum terminale, orbiculatum, depressum, arctissime spadicibus ferrugineo-tomentosis imbricatum, undique intus gummi scatens, squamis spatheis tomentosissimis pluribus brevibus cinctum. Spadix basi anceps, apice dilatatus in squamam crassam, incurvam, ovatam, mucrone rigido acuminatissimam, utrinque pectinatam. Flosculi utrinque 2 vel 3 foveis totidem in basi spadicis utrinque insculptis nidulantes.

Calyx vel petala nulla. Germen compressum. Stylus nullus. Stigma acutum.

Capitulum fructiferum arcte spadicibus acutissimis imbricatum.

Drupa obliqua, obovata, magnitudine ovi compressa, basi hylo notata, nuda, rugosa. Cortex tenuis, papyraceus, arcte adhærens. Caro tenuis, fungosa, ossiculo adnata. Putamen forma fructus osseum, tenue, læve, basi acuminatum, et poro perforatum. Receptaculum nullum, semine ad apicem putaminis adhærente. Semen unicum fructu forma conforme. Integumentum intus nitidum, spadiceum, membranaceum, putamini adhærens, ab interioribus facile secedens, apicem incrassatum

intra hilum albuminis immittens. Albumen semine conforme, oblique compressum, obsolete sulcatum, carnosum, album. Embryo oblongus, utrinque acutus, verticalis, ex apice albuminis poris nonnullis pertuso ramentis umbilicalibus contortuplicatis dependens.

OBS. Quod ego *embryonem* vocavi, Brownius (Nov. Holl. i. 347) pro *vitello* embryonem includente habuit.

Differt a *C. circinali* spadicibus fœmininis profundius incisiss, fructiferis erectis, incurvis.

Olus calappoides, e Celebe cujus fœminina Lagogo et masculina Patuka vocantur, p. 87; ut et illa ex Insulis Ulasseriensibus, p. 89, t. 22 et 23.

The account of these plants given by Rumphius is not very distinct. He seems especially to have been uncertain whether or not the Lagogo and Patuka of Celebes were different from the Olus *calappoides* figured in plates 20 and 21, and in Amboina called Nuvel and Utta Nuer. Perhaps they are really the same, although, in the explanation (p. 91), tables 22 and 23 are referred to the Lagogo and Patuka. The explanation of the plates, however, seems to have been written by Burman with little care; and it may be suspected that these two plates represent the palms which were brought to Rumphius from the Uliasser Islands. They, no doubt, represent the *Todda panna* of the Hortus Malabaricus, and are therefore justly quoted by Burman (Fl. Ind. 240), Willdenow (Sp. Pl. iv. 844), Roxburgh (Hort. Beng. 71), and the Compilers of the Encyclopedie (ii. 23), for the *Cycas circinalis*; while the description given of the female spadix of the Olus *calappoides* (tables 20 and 21) renders it certain that the latter figures represent a totally different plant, notwithstanding the assertion of Loureiro (Enc. Meth. Supp. ii. 425).

The *Cycas circinalis* is a very common plant in Malabar, and I suppose must have been mistaken for the *Sagus ra-*

phia; and a report of this circumstance must have led the Compiler of the Encyclopedie (vi. 393) to make this a native of India, especially of Malabar. But having travelled much through this latter country, as well as through India in general, if this name is confined to Hindusthan, I may venture to say, that neither produces any species of Sagus, and the Todda *panna* is the only plant of Malabar that could be mistaken for such. Willdenow seems therefore perfectly right in confining the Sagus *raphia*, which he calls *Ruffia* (Sp. Pl. iv. 403), to Madagascar, although it may probably be found in other parts of Africa.

Planta Osmundæ genere Pappa dicta, p. 89.

We have no figure of this plant, which is a native of Celebes; nor are we even certain of its not being actually a Fern; but it is more probably a *Cycas*.

Arbor calappoides sinensis, p. 92, t. 24.

All modern authors agree in calling this the *Cycas revoluta*, the female fructification of which has been most accurately described and delineated in the 6th volume of the Linnæan Transactions, by my worthy friend Sir J. E. Smith. A very great difficulty occurs in Thunberg making this the tree, the stem of which produces a most nutritious substance, so precious, that it is a capital crime to export the tree from Japan, while its fruit is an esculent drupe. The drupe probably may be used as a wretched aliment in times of scarcity, as is the case in Malabar with that of the *Cycas circinalis* (Buchanan's Mysore, ii. 469); or in times of mourning, as, according to Rumphius (p. 90), is done in Tamboca: but this intelligent and inquisitive author denies his ever having heard that a nutritious substance like sago could be procured from the stem of the *Olus ca-*

Iappoides sinensis (p. 92), and he says that it is cultivated by the Chinese and Japonese as an ornament,—“ob plumosam ejus formam.” Rumphius spells its Chinese name Titsjiu, which is no doubt the same with Tessio, the more learned name of the *Cycas revoluta*, which is called Sotits, and Sodots, by the vulgar in Japan. I am inclined to suspect that the resemblance, however imperfect, between these latter names and Setitsou, Sotectsou, and Soteetsou, is the only foundation for supposing that the *Cycas circinalis* produces the most valuable kind of sago; and I am inclined to think that the Setitson is not, as Rheede supposed, a *Cycas*, but a real *Sagus*.

CAPUT XXI.

Manga domestica, p. 93, t. 25.

This is the *Mangifera Indica* of Linnæus and subsequent authors, a name as improper, as if we were to call the apple-tree *Malifera Europæa*. The species of *Manga* mentioned by Rumphius are varieties, in a botanical sense; and, in fact, the varieties cultivated in India are fully as numerous as those of the apple found in Europe.

Manga Pau in Banda vocata, p. 96, t. 26.

In neither description nor figure can I discover any essential difference between this and the *Manga domestica*.

Manga sylvestris prima, p. 97.

Manga sylvestris secunda, p. 97.

Table 27 is said to represent the *Manga sylvestris*, but no notice is given to which of the species it should be referred. If we might venture to judge from the position of the leaves in the figure, this should be the *Mangifera oppositifolia* of the Hortus Bengalensis (18), of which I trans-

mitted an account from Ava, which was given to Sir Joseph Banks under the name of *Mangifera Marian*, the latter word being its name in the language of Ava.

Arbor ramis angulatis; foliis oppositis, petiolatis, lanceolatis, integerrimis, acuminatis, venosis, nitidis, nudis. Petiolus brevissimus, supra concavus, estipulaceus.

Spicæ simplicissimæ, folio multum longiores, axillares et terminales. Pedunculus tetragonus, acutangulus. Flores terminales terni; laterales oppositi, solitarii, sessiles, remoti: explanatos non vidi.

Drupa compressa, flava, pulcherrima, glabra, figura et sapore mangiferæ indicæ, ossiculo fibroso solitario monospermo.

From the inflorescence, as above described, it will appear, that, however nearly allied by the singular position of the leaves, the Marian must be different from the plants of Rumphius, which have the flowers disposed in panicles. The two kinds of this author seem distinct species, which may be thus distinguished from each other, and from the Marian. The name given to this latter by Dr Roxburgh is now improper, being equally applicable to two other species.

1. *Mangifera Mariana* foliis oppositis, floribus spicatis, pedunculo tetragono.
Mangifera oppositifolia, Hort. Beng. 18.
Ma-ri-an Burmanorum.
Habitat in regno Peguensi.
2. *M. Utana* foliis oppositis, floribus paniculatis, fructu glabro.
Mangifera sylvestris prima, Herb. Amb. i. 97, t. 27?
Habitat in Amboina et Insulis vicinis.
3. *M. Taipa* foliis oppositis, floribus paniculatis, fructu piloso.
Mangifera sylvestris altera, Herk. Amb. i. 97.
Habitat in Amboina et Insulis vicinis.

CAPUT XXIII.

Manga fœtida, p. 98, t. 22.

On the authority of Loureiro this has been described in the Encyclopedie (Sup. iii. 583) under the name of *Mangifera fœtida*. The acrimony of the juice, in its bark, shews a strong affinity with the genus which I called *Holigarna*, a name adopted by Dr Roxburgh (Hort. Beng. 22).

CAPUT XXIV.

Durio, p. 99, t. 29.

This is the *Durio zibethinus* of modern botanists. The species mentioned by Rumphius are merely such varieties as occur in plants much cultivated.

CAPUT XXV.

Saccus arboreus major, p. 104, t. 30.

I think there can be no doubt that this is the same with the *Tsjaca maram* of the Hortus Malabaricus. I know no tree better, and every word that Rumphius says, so far as I can judge, I consider applicable to the common *Jaca* tree of India. Notwithstanding this, Willdenow, for his *Artocarpus integrifolia*, does not quote this account, which, in my opinion, is better than that of Rheede; and the Compilers of the Encyclopedie consider it as a distinct species, calling it *Artocarpus heterophylla*, while the *Tsjaca Maram* they call *A. Jaca*. It is true, that they quote this plant of Rumphius with doubt, and therefore their *A. heterophylla* may be a real species; but I would observe, that, some of the leaves being entire and others lobed, is no proof whatever of a distinct species; all the species of *Artocarpus* that I know, the Bread-fruit excepted, having the leaves on their young plants lobed, while those on the

adult plants are entire. The names *integrifolia* and *heterophylla* are therefore ill applied to any particular species.

If, however, the *Artocarpus heterophylla* be really a distinct species, the plant of Rumphius is wrong quoted in the *Encyclopedie* (iii. 209), and I have no doubt is identically the same with the *Tsjaca Maram* of the *Hortus Malabarius* (iii. 17, t. 26, 27, 28); nor does it form even a variety, as Willdenow would have it (*Sp. Pl.* iv. 189). The different species mentioned by Rumphius are the real varieties which occur in this, as well as in all other plants, that are much cultivated.

Burman, in his observation on this plant, I suppose, is in an error, when he refers to the *Waal mendya* of Herman as being the same. I believe there can be little doubt of the *Waal mendya* being the *Grewia orientalis* (*Lin. Fl. Zeyl.* 324). In the *Supplement to the Encyclopedie* (v. 619) is some farther account of this tree, under the name *Choopada*. The proposal of Gærtner and Commerson to place this tree in a separate genus from the Bread-fruit-tree seems to me unnecessary, and to rest upon circumstances too minute, where the number of species is moderate, the plants nearly resembling each other in general appearance, and the characters distinguishing from other genera clearly marked.

CAPUT XXVI.

Saccus arboreus minor, p. 107, t. 31.

The Compilers of the *Encyclopedie* (iii. 210) consider this as a variety of the *Artocarpus Jaca*, in which they are followed by Willdenow (*Sp. Pl.* iv. 189); but there is reason to think that it is a very distinct species, the pubescence on the leaves, and the different forms of the amenta, being sufficient marks of distinction. I have, however, never seen any plant that I could refer to this species.

It must be observed, that Willdenow considers the *Rademachia integra* of Thunberg as the same with the *Tsjaca maram* of Rheede, which, as I have said, is the *Saccus arboreus major* of Rumphius; while the Compilers of the Encyclopedie (iii. 210) consider it as the same with the *Saccus arboreus minor*, and as being the original *Artocarpus integrifolia* of the younger Linnæus.

Saccus arboreus minor alterus, p. 108.

Saccus arboreus minor tertius, p. 108.

From the short notices given of these plants in the text, it is impossible to say whether or not they should be considered as varieties, or as species. In plants, however, so little cultivated as these would seem to be, the latter opinion is the most probable.

Angelyquen vel Caju Bandaa, p. 109.

Burman in his observation wonders that Rumphius should have confounded his *Saccus arboreus minor* with the *Ansieli* of the Hortus Malabaricus (iii. t. 32); but he seems to have read no more of Rumphius than the title of the chapter, for the latter nowhere says any such thing. Towards the end of the chapter, after having described three kinds of the *Saccus arboreus minor*, he proceeds to state, that, in Malabar, there is still another kind of *Saccus arboreus*, with a small fruit, which is there called *Angelyquen*; and afterwards, in an appendix, he adds, that the same kind is found in Java, where it is called *Caju Bandaa*, and that it is the same with the *Ansieli* of the Hortus Malabaricus. Now, this is a very distinct species, which the Compilers of the Encyclopedie (iii. 210) called *Artocarpus hirsuta*. Willdenow chose (Sp. Pl. iv. 189) to call this plant *Artocarpus pubescens*, quoting the Encyclopedie with

doubt, but the Hortus Malabaricus without reserve. Why he did so, I cannot exactly say. He indeed calls the leaves "subtus pubescentia," while the Compilers of the Encyclopedie call them "inferne aspera;" but in this they are completely justified by Rheede, who says "folia inferne aspera et manui tangenti adhærentia." Both authors, I suspect, have fallen into an error, copying from the drawing of Rheede, and attributing to the plant "amenta mascula pendula." Neither Rheede nor Rumphius mention this circumstance, and the appearance in the plate I consider as originating in the specimen, from which the drawing was taken, having been kept until the parts became somewhat flaccid.

In 1801, I found a tree in Malabar, and the adjacent territory, which I have scarcely any doubt is the Anseli; and I took specimens and a drawing, which in 1806 I gave to Sir J. E. Smith, and the following description was taken on the spot.

Artocarpus hirsuta, Enc. Meth. iii. 210.

Artocarpus pubescens, Willd. Sp. Pl. iv. 189.

Caju Bandaa vel Angelyquen, Herb. Amb. i. 109.

Anseli, Hort. Mal. iii. 25, t. 32.

Heb Helasu Carnatæ.

Aiony Malyalæ, Buchanan's Mysore, ii. 436.

Habitat in Malyalæ sylvis et ad pagos.

Arbor inter altissimas, linitribus conficiendis apta. Rami teretes, lactescentes, ad folia annulo cincti, pilis fuscis appressis hispidi. Folia alterna; in adulta planta magnitudine *Artocarpi integrifoliae* foliorum, margine revoluta integerrima, integra, nervis supra depressis costata, venosissima, supra nitida, subtus nisi ad costas hispidas glabra: in plantis junioribus maxima, incisa. Petiolus brevissimus, depressus, pilis fuscis appressis hispidus. Stipulæ gemmaceæ, caducæ, hispidæ, geminæ, ut in afinibus dispositæ.

Pedunculi axillares plerumque gemini, erecti, teretes, hispidi, petiolo duplo longiores, ebracteati, uniflori. Masculinum amentum teres, longitudine folii erectum, undique floribus imbrica-

tum. Fœmininum sæpe in eadem cum masculino axilla positum, magnitudine nucis juglandis globosum.

M. Calyx monophyllus, cyathiformis, ore irregulari dehiscentis. Filamentum unicum, teres, calyce duplo longius. Anthera parva, rotunda.

F. Germina plurima, teretia, pilosa. Styli brevissimi. Stigmata acuta.

Fructum non vidi.

In the part of the country north from Malabar, I found a tree very nearly allied to that above described, and, in Tulava, called Pe Jaca; but I did not see any part of its fructification. Its leaves were very scabrous above, and very slightly indented on the edges. Notwithstanding this, I am, however, inclined to think, that it may be the same with the Chama of the Bengalese, which I found on the hills near Goyalpara, and which is probably the same with the Chaplasha of Chatigang, which I sent to Dr Roxburgh in the year 1798, but of which I preserved no description. The following is an account of the Chama.

Artocarpus Chama foliis plantæ adultæ integris, subrotundis, basi emarginatis, utrinque hispidis; amentis masculinis orbiculatis, compressis.

Artocarpis Chaplasha, Hort. Beng. 66?

Chama Bengalensium.

Habitat in Camrupæ orientalis sylvis.

Arbor excelsa, lactescens. Ramuli teretes, annulati, hispidi. Folia decidua, alterna, subrotunda, basi profunde emarginata, mucronata, integerrima, utrinque hispida, supra et scabra, costata, reticulatissima: plantis junioribus maxima, pinnatifido-sinuata, serrata. Petiolus brevissimus, depressus, hispidus. Stipulæ gemmaceæ, geminæ, carinatae, deciduæ, pilis sericeis pubescentes, foliis in gemmæ conduplicatis.

Pedunculus masculinus, quatenus ego vidi, ex axilla folii anni præteriti, unde facie infrafoliaceus, flore multo longior, teres, solitarius, hispidus, erectus. Amentum suborbiculatum, magnitudine cerasi compressum. Pedunculus fœmininus masculino similis, amento subrotundo compresso obliquo.

CAPUT XXVII.

Soccus lanosus, p. 110, t. 32.

Willdenow (Sp. Pl. iv. 188) calls this *Artocarpus incisa* β , considering it as a cultivated variety of the following plant; and in the Encyclopedie both are quoted, without distinction, for the *Artocarpus incisa* (iii. 207), while the *Soccus sylvestris* is considered the variety β : but these suppositions seem to me devoid of foundation, and I agree with Rumphius in considering the three species distinct. This is distinguished by its smooth leaves; and Rumphius enumerates several different kinds, some of which are spontaneous, but still different from the *Soccus sylvestris* or *Soccus granosus*. These kinds are, however, I think, to be considered as varieties, arising as usual from cultivation. See Sookoon, under the head Choopada (Suppl. v. 619) in the Encyclopedie.

CAPUT XXVIII.

Soccus granosus, p. 112, t. 33.

This, as mentioned in the Commentary on the foregoing plant, is the *Artocarpus incisa* α , of Willdenow (Sp. Pl. iv. 188), from which it may readily be distinguished by having its leaves scabrous above, and woolly beneath. Of this also Rumphius enumerates both cultivated and spontaneous varieties,—a proof of its being a species really distinct from the preceding.

CAPUT XXIX.

Soccus sylvestris, p. 114, t. 33.

The Compilers of the Encyclopedie (iii. 208) call this *Artocarpus incisa* β ; but they suspect that it may be a distinct species, in which I entirely agree with them. Its

leaves are so bristly that they can scarcely be handled, or even touched.

Soccus sylvestris celebica, p. 115.

This is evidently an *Artocarpus*, with entire leaves, which, together with the footstalk and fruit, are covered with hairs. It may very possibly be the same with the *Artocarpus Lacucha* of Dr Roxburgh (*Hort. Beng.* 66), a tree very generally diffused over India. The account given by Rumphius is too imperfect to admit with certainty of the plant of Celebes being considered the same with the *Lacucha*; but he says nothing to contradict this opinion, as will appear from the following description of the *Lacucha* taken by me in Ava during the year 1795, from whence I sent specimens, now in the collection of the late Sir Joseph Banks.

The tree is called *Lacucha* in the Sanskrita, *Baral* in the Hindwi, *Dephal* in the Bengalese, and *To Pi-nah*, or Wood-Jaca, in the language of Ava.

Arbor mediocris. Ramuli viridescetes, pilis fuscis dense tecti, lactescentes. Folia alterna, internodiis multo longiora, ultra 6 pollices longa, oblonga, basi cordata, cum acumine brevi obtusa, denticulis parvis remotis serrata, utrinque hispida, supra nitida, venis reticulata, costata. Petiolus brevis, teres, villosus. Stipulæ gemmaceæ, geminæ, subulatæ, caducæ, villosæ, petiolo dimidio breviores.

Amenta masculina magnitudine fabæ arvensis pedicellata, axillaria, plerumque gemina.

Fructus subrotundus, magnitudine pugni, forma irregularis, flavescens, cortice tenui pubescenti rudimentis stigmatum notato sed non areolato tectus, succo lacteo scatens, pulposus. Semina ovata, compressa, albida, arillo carnosio tecta, receptaculo centrali lignoso tereti insidentia.

Soccus sylvestris fœmina, p. 15.

This also is undoubtedly an *Artocarpus*; but I have seen nothing resembling it.

CAPUT XXX.

Prunum stellatum angulosum, p. 115, t. 35.

This fruit was noticed by very early botanical writers; but seems very inferior in ancient India, where I have seen it, to what it would seem to be in the Indian Archipelago, as described by Rumphius. Rheede (Hort. Mal. iii. 51, t. 43 & 44) gives a good account of it, as found in ancient India. Plukenet then mentions it in two places; first, (Alm. 238) under Ray's name, "Malus Indica pomo anguloso Carambolas dicta;" and, secondly, (Mant. 36), under the name of "Carambola, Malabarorum Tamaratonga Horti Malabarici." The elder Burman (Thes. Zeyl. 148) calls it "Malus Indica, foliis sennæ occidentalis, fructu acido, pentagono, sulcato, floribus rubris." He also gives the synonyma of preceding authors with tolerable care; and mentions the true Indian name, *Kama-ranga*, derived from *Karma-ranga* of the Sanskrit; but his explanation of this name is totally absurd. The description of Rumphius comes next in order, and is excellent. The sweet and sour kinds mentioned by him are varieties, such as occur in all plants much cultivated. Linnæus, in publishing the *Flora Zeylanica*, established the genus *Averrhoa*, and made this one of the species (178), as is usual in that work, quoting the synonyma with admirable care. In the *Species Plantarum* it obtained the specific name *Carambola*, and continues to be called by this appellation in all subsequent authors of note; yet this name is of very doubtful origin. It is true, that Rheede asserts it to be the name in use with the Brahmans of Malabar; but he adds also, and with the Portuguese, a coincidence that would be remarkable; but the Sanskrita name is *Karma-ranga*, in the vulgar dialects of the north corrupted into *Kama-ranga*, a name which extends from the Ganges even to Ceylon; and I suspect

that even the Tamaratonga, which Rheede says is the vulgar name in Malabar, is a mere corruption, by errors in copiers and printers, of the same word. As for Carambola, it is, I suspect, one of those productions of careless travellers, which are considered as Indian words by Europeans, and as European words by the Indians.

CAPUT XXXI.

Blimbingium teres, p. 118, t. 35.

The synonyma of older authors may be found in the elder Burman (*Thes. Zeyl.* 147), and in the *Flora Zeylanica* of Linnæus (177). This great author, in his *Species Plantarum*, called it *Averrhoa bilimbi*, preferring the uncouth name of Rheede, corrupted from the Malay; while Rumphius afforded two good specific names, *stellatum* and *teres*, for the two species of *Averrhoa*, which he described. The names of Rheede, however, continue to be used by all recent authors of note.

CAPUT XXXII.

Jambosa domestica, p. 121, t. 37.

This is undoubtedly the *Eugenia Malaccensis* of all botanists since the time of Linnæus; and, for what I have to say on the subject, I may refer to my Commentary on the First Part of the *Hortus Malabaricus*, (*Lin. Trans.* xiii. 481). I have here, however, to add, that this fruit, in its native country, the Eastern Archipelago, has a superior quality to what it possesses as an exotic in ancient India. I believe also, that all the kinds mentioned by Rumphius, even the *Jambosa calapparia* (p. 122), are merely such varieties as occur in all plants that are much cultivated.

Jambo d'Agoa Rosada, p. 123.

This, as I have mentioned in the Commentary on the Hortus Malabaricus (l. c.), seems to me the *Eugenia Jambos*, the Portuguese name being a mere translation of Gulab Jamba, the Hindwi name of this fine tree. Burman's observation on the *Jambosa domestica* (p. 124) is full of errors, mentioned in my Commentary on the Hortus Malabaricus, Part i. p. 27.

CAPUT XXXIII.

Jambosa nigra, p. 125, t. 38, f. 1.

This is quoted by Willdenow (Sp. Pl. ii. 959), along with the former, for the *Eugenia Malaccensis*; but it seems a distinct species, and, without being certain, I believe that it is the *Eugenia purpurea* of the Hortus Bengalensis (p. 35), introduced there by Mr Colebrooke, who, I suppose, gave it this name, which I find in no botanical writer. The plant of Rumphius is not, however, quoted in the Hortus Bengalensis. The observation of the elder Burman, at the end of this chapter, is, in my opinion, totally erroneous, no one of the plants quoted being the same.

CAPUT XXXIV.

Jambosa aquea, p. 126, t. 38, f. 2.

In the Encyclopedie (iii. 200) this is quoted with doubt for the *Eugenia Javanica*; but as the fruit of the latter has not been described, nothing certain concerning this question can be determined. In the Hortus Bengalensis (37), without quoting Rumphius, this elegant species has been called *Eugenia aquea*. It was brought, along with the preceding, by the fleet of Admiral Raynier, after the capture of Amboina; and, in the year 1800, I saw both in the

garden of the late worthy Dr Anderson, at Madras. The Bengalese name given to the *Jambosa aquea* is perfectly generical, and it has been called Jamb by the gardeners, just as any foreign species of *Quercus* might by a common labourer be called Oak. Considering the deserved high authority of this work respecting the native names of plants, I think this explanation necessary; as a Bengalese name might imply the plant being a native of that country. The kind with a white fruit, mentioned by Rumphius, seems a mere variety, the effect of cultivation.

CAPUT XXXV.

Jambosa silvestris alba Utan Puti, p. 128, t. 39.

In my Commentary on the Hortus Malabaricus (P. i. fol. 27), I have mentioned the mistake into which modern botanists have fallen, in quoting this for the *Eugenia jambos*. I have no doubt of its being a totally different species, which hitherto has not been properly applied to any plant recently described.

Jambosa silvestris alba Biawas, p. 128.

It is impossible to say, from any thing mentioned by Rumphius, whether this should be considered as a distinct species, or as a mere variety of the foregoing. If Burman was wrong in comparing these two plants to the Malacca *Schambu* of Rheede, which is at least of the same genus, he erred much more in comparing them to the Catu *Tsiambu* (Hort. Mal. iv. t. 8), which does not seem to belong to the same family.

Jambosa silvestris parvifolia, p. 129.

In the Actuarium or Appendix to this Work (cap. 6) we are informed that a transposition of plates has taken

place; and that the plate representing this *Jambosa* is given in vol. ii. tab. 40; while the 40th plate of this first volume represents the *Radix Deiparæ spuria*, described in vol. ii. p. 127. After this we can only account for the *Jambosa silvestris parvifolia* being quoted for the *Gmelina Asiatica* in Willdenow (Sp. Pl. iii. 313), by supposing, that he looked merely at the drawing, without reading the description. The Compilers of the *Encyclopedie* (ii. 739) noticed the discrepancy between the description and figure prefixed, but do not seem to have consulted the *Actuarium*, so as to refer the figures to their proper places. I have no doubt of the *Jambosa silvestris parvifolia* being an *Eugenia*, and cannot see any resemblance between it and the *Blatti* of the *Hortus Malabaricus* (iii. t. 40), or *Soneratia acida*, with which Burman in his observation compares it.

Jambosa silvestris Jamboe Ayer Utan dicta, p. 129.

When in the north-west parts of Mysore, in the cool moist woods bordering on the lower sea-coast, I observed a tree which seemed to have a great resemblance to this plant of Rumphius; only, from not having seen the fruit, I remain doubtful. I shall, however, describe what I saw, of which Sir J. E. Smith has the specimens that I brought home in 1806.

Eugenia læta foliis ellipticis, acuminatis, non punctatis; pedunculis unifloris terminalibus, subgeminis.

Habitat in Carnatæ occidentalis sylvis.

Arbuscula ramis teretibus, glabris. Folia opposita, elliptica, acuminata, integerrima, glabra, absque nervo marginali subcostata, venosa. Petiolus brevissimus, estipulaceus.

Pedunculi terminales, sæpius gemini, uniflori, petiolo multoties longiores, incrassati, in medio articulati, nudi. Flores magni, squamula ad calycis basin bracteati, staminibus incarnatis albi.

Calyx quadripartitus laciniis subrotundis. Petala quatuor, calyce multo majora, subrotunda, caduca. Stamina plura, perigyna, petalis longiora. Germen inferum, oblongo-turbinatum. Stylus unicus.

What Rumphius says of a verruca growing below the leaves, and spreading out into a substance resembling the *Cupressus marinus*, seems either to relate to some *Viscum* or *Psilotum*, or to some disease similar to that which we observe in Europe on the *Betula alba*.

CAPUT XXXVI.

Jambosa ceramica, p. 130, t. 41.

Linnæus, in the *Flora Zeylanica* (182–186), described as species of *Myrtus* five plants, which he acknowledges scarcely belong to that genus, and which should rather be considered as forming one, that should be called *Myrcia*, and of which he gives the natural characters at full length. More modern botanists have availed themselves of this hint, and Swartz adopted this genus, but chose to give it the hard Greek name *Calyptranthes*. One of these five plants, which Linnæus at first (*Fl. Zeyl.* 185) called *Myrtus foliis lanceolato-ovatis*, he afterwards, in the *Species Plantarum*, called *Myrtus cumini*. The synonyma, which Linnæus quoted for this, were, the *Arbor Zeylanica cuminum redolens* of the elder Burman (*Thes. Zeyl.* 27), and the *Ankaenda* of Herman (*Mus. Zeyl.* 23). We are indebted to the late Dr Dryander (*Linn. Trans.* ii. 232) for having here pointed out an error in Herman; and that in his *Herbarium* the tickets of the Madan and Ankaenda must have been changed. The synonyma, therefore, of Linnæus are totally wrong, as he described the plants of Ceylon from the collection of Herman. The *Arbor Zeylanica Cuminum redolens* and the *Ankaenda* belong therefore to the *Jambolifera* of Linnæus (*Fl. Zeyl.* 139); while the *Prunus In-*

dica fructu nigro (Burm. Thes. Zeyl. 197), the *Jambolones* (C. B. P. 466), the *Jambolous* (Acost. Aromat. 209), and the *Madan* (Herm. Mus. Zeyl. 8), are really the plant (Fl. Zeyl. 185) which Linnæus afterwards called *Myrtus Cumini*. As the generic name *Jambolifera*, and the specific name *Cumini*, are thus totally founded in error, Gærtner has done perfectly right in changing the former to *Cyminosma* (De Sem. i. 280, t. 58, f. 6); and Willdenow should have transferred all the synonyma, given by mistake in the *Flora Zeylanica*, to the *Calyptranthes Jambolana*, which, without any doubt, is the same plant with the *Myrtus Cumini*. An unfortunate error, however, in the younger Burman, has led Willdenow into still greater mistakes. The former quoted, as synonymous with the *Myrtus Cumini*, the *Jambosa ceramica*, of which I am now treating; and the latter, joining this with some of the synonyma which Linnæus by mistake had given to the *Jambolifera* or *Cyminosma*, made it into a species, which he called *Calyptranthes caryophyllifolia*, a name which he borrowed from a mistake in the *Encyclopedie*. In this valuable work (iii. 198), the *Perin Niara* of the *Hortus Malabaricus* (v. 57, t. 29) is considered as different from the *Jambolana* described by Rumphius in the next chapter, because the painter of the latter, in attempting awkwardly to represent the leaves in proper perspective with their points bending a little backward, “*folia rotundo terminantia cum brevi apice, quæ deorsum inflectitur,*” has represented them as deeply emarginated; but, on a careful examination of the descriptions of both authors, with a tree most perfectly known to me, I have not the smallest doubt that the *Perin Niara* and *Jambolana* are quite the same, and that Willdenow is wrong in referring the *Jambosa ceramica* to this species. In the *Encyclopedie*, it is considered, with some doubt, as belonging to the *Eugenia cymosa* of that work

(iii. 199). This doubt arises from its having been quoted as the *Myrtus Cumini* of Linnæus; but the deep division of the calyx, very evident in the figure of Rumphius, and his having described the real *Myrtus Cumini* under the name *Jambolana*, removes all doubt from my mind. I think that, in the woods of Chatigang and Goyalpara, I have seen the tree; but as I have not seen the fruit, I am uncertain, in a genus the species of which are so difficult to determine. In 1798 I sent specimens to Sir Joseph Banks, under the name of *Eugenia calyptrata*, and I now shall mention what I quoted on the spot.

Eugenia cymosa, Enc. Meth. iii. 199.

Jambosa ceramica, Herb. Amb. i. 130, t. 41.*

Bara Jamba Bengalensium.

Habitat in Camrupæ, Tripuræ, et Indiæ aquosæ sylvis.

Arbor mediocris. Folia magna, coriacea, ovalia vel ovata, sæpius utrinque obtusa cum acumine ad apicem obsolete, costata, venosa, costis et venis sensim evanescentibus, odore aromatico.

Paniculæ ex anni præteriti ramulo infra folia nova enatæ ramis tetragonis.

Calyx quadrilobus. Petala quatuor, apicibus acutis conniventibus intra stamina incurva insertis, simul caduca, operculum peltatum mentientia.

Fructum non vidi, sed dicitur malum magnitudine æquare.

Jambosa silvestris Lahunensis, p. 130.

This seems evidently to be an *Eugenia*; but I know nothing farther of it than is here mentioned by Rumphius.

CAPUT XXXVII.

Jambolana, p. 131, t. 42.

Most of what I had to say concerning this plant has been anticipated in the Commentary on the *Jambosa ceramica*. It now remains to give what I consider the true synonyma, and a description; and I must do justice to Burman in

stating, that the synonyma which he gives to this plant seem correct.

Eugenia Jambolana, Enc. Meth. iii. 198; Hort. Beng. 37.

Eugenia caryophyllifolia, Enc. Meth. iii. 198.

Calyptranthes Jambolana, Willd. Sp. Pl. ii. 975; Hort. Kew. iii. 191.

Calyptranthes caryophyllifolia, Willd. Sp. Pl. ii. 975, exclusis synonymis Rumphii et Burmanni.

Myrtus Cumini, Burm. Fl. Ind. 115, exclusis synonymis Rumphii et Burmanni.

Myrtus foliis lanceolato-ovatis, Lin. Fl. Zeyl. 185, exclusis synonymis.

Prunus Indica, fructu nigro, Olivæ magnitudine, Jambulous Acostæ, Madan Zeylonensibus, Burm. Thes. Zeyl. 197, exclusis synonymis Plukenetii, Sloani, et Rayi.

Jambolana, Herb. Amb. i. 131, t. 42.

Caryophyllus, languescens vi aromaticus, Malabarensis folio et fructu maximo, Pluk. Alm. 88; Phyt. t. 274, f. 2; Mant. 39.

Perin Niara, Hort. Mal. v. 57, t. 29.

Jati Jam Bengaliensium.

Jamun Hindice.

Habitat ubique ad Indiæ pagos.

Arbor mediocris. Folia rigida, oblonga, basi sæpius obtusiuscula, apice reflexo plerumque acuminata, venis parallelis in venam submarginalem desinentibus, reticulata, poris minutis perforata, odore languido aromatico amara. Petiolus quartam folii partem longitudine attingens, obtusangulus.

Paniculæ nunc axillares, tunc terminales, sæpius tamen in ramuli parte foliis nudata.

Calyx truncatus. Bacca Olivæ magnitudine utrinque obtusa, sed apicem versus sæpius crassior, umbilico profundo rimo semper obliquo coronata, nigra, monosperma. Caro crassa, succo tingente scatens, ex purpurascens alba. Receptaculum nullum. Semen oblongum, utrinque obtusum, bacca multoties minus. Integumentum crustaceum, friabile. Albumen nullum. Cotyledones crassæ, hinc planæ, inde convexæ, transversæ. Radicula unum latus versus inter cotyledones nidulans.

In the woods of Behar, or Magadha, I found a tree differing in no respect from the above description, except that

the fruit was much smaller, and the leaves sharp towards the footstalk. It was called Janggali (sylvestris) Jamun (*Myrcia*) by the natives, and I consider it as the spontaneous kind of this species, while the large fruit I consider as the effect of cultivation. It must be observed, that the name Janggali *Jamun* is given also to another species, which I call *Calyptranthes tenuis*, although I think *Myrcia tenuis* would be a more Linnæan and proper denomination.

CAPUT XXXVIII.

Mangostana, p. 132, t. 43.

This is the *Garcinia Mangostana* of all modern botanists.

Mangostana celebica, p. 134, t. 44.

Linnæus, in the first edition of the *Species Plantarum*, called this *Garcinia celebica*, and was imitated by Burman (*Fl. Ind.* 109), Willdenow (*Sp. Pl.* ii. 848), and the Compilers of the *Encyclopedie* (iii. 700). Loureiro having observed that the flower of the *Folium acidum majus* of Rumphius (iii. 58) differed somewhat from that of the *Mangostana*, established it for a new genus, which he called *Oxycarpus*. It was afterwards discovered by M. du Petit-Thouars, that the *Garcinia celebica* belonged to the same genus; but he chose to give this a new name, *Brindonia*, from *Brindones*, the appellation by which Garcias, John Bauhin, and other old botanists, knew its fruit. This innovation the Compiler of the Supplement to the *Encyclopedie* (iv. 258) properly rejects, and calls the plant *Oxycarpus celebica*; but he rejects all the synonyma of these ancient authors, transferring them to the *Oxycarpus indica*. This he has done with great propriety, because the *Mangostana celebica* has a white juice, while that of the

Mundo and Brindonia is yellow, changing into an imperfect gamboge.

In the woods, south from the Ganges in Magadha, I have found a tree, which, as its fruit has only four seeds, I should have taken to be the Brindone; but the juice of the tree is limpid, or white, like that of the Mangostana or *Oxycarpus celebica*; and the figure and account given by Rumphius of this agree so well with the Gangetic plant, that I should have considered them as the same, did it not appear clear that the Mangostana *celebica* is dicecious, having male-trees that produce no fruit. This, so far as I know, is not the case with the Gangetic plant, which produces both male and hermaphrodite flowers on the same stem. It may, however, have trees producing male flowers alone, although such escaped my notice in travelling; for I found the tree in no other place. I shall here, however, describe it as the *Oxycarpus gangetica*, leaving it to be determined by farther observation, whether or not it be really distinct from the *Oxycarpus celebica*.

Oxycarpus Gangetica foliis lanceolatis, floribus in eadem arbore masculinis et hermaphroditis, bacca tetrasperma.

Habitat in Magadhæ sylvis.

Arbor magna. Ramuli glabri, teretes, succo aqueo scatentes. Folia opposita, lato-lanceolata, utrinque acuta, glabra, nitida, integerrima, uninervia, venosa, acida. Petiolus brevissimus, glaber, marginatus. Stipulæ nullæ.

Flores parvi, flavi, monoici. Masculini laterales, hermaphroditis terminales. Pedunculus flore brevior, teres, glaber, uniflorus; hermaphroditis solitarius.

M. Calyx tetraphyllus foliolis ovalibus, concavis, coloratis, exterioribus duobus minoribus. Petala quatuor, erecta, ovata, obtusa, calyce longiora. Receptaculum centrale tetragonum, antheris angulatis subsessilibus tectum.

H. Calyx et corolla ut in Masculo. Filamenta quatuor, multifida. Antheræ plures, angulatæ. Germen utrinque attenuatum, apice quadrilobum, quadriloculare. Stylus brevissimus. Stigma quadrilobum, lacerum.

Maturum fructum non vidi: immaturus succi flavi pauxillo tantum præditus.

Very nearly allied to the above is another tree, which I have seen at Goyalpara, which the natives call Sopsopiya, and which has a fruit that is not very bad for eating. Of this also I shall here give some account, although I have not seen the flower.

Oxycarpus? *Sopsopia* foliis ellipticis obtusis, baccis oblongis
4 seu 5 locularibus, pedunculis multifloris.

Sopsopiya Bengalensium.

Habitat in Camrupæ sylvis.

Arbuscula ramulis glabris, compressis. Folia elliptica utrinque obtusiuscula, costata, venosa, glabra, acida cum amaritudine quadam. Petiolus teres, marginatus, brevissimus, estipulaceus.

Pedunculi terminales, gemini, tetragoni, articulati baccas gerunt tres vel quatuor cum aliorum rudimentis, unde forte flores sunt duorum parium lateralium cum quinto terminali.

Bacca lævis, fructus juglandis magnitudine oblongiuscula, stigmate peltato orbiculato crenato coronata, calyce minimo tetraphyllo insidens. Foliola obtusa alternis minoribus. Cortex in fructu maturo tenuis, intus ramentaceus, membranaceus; in immaturo succo flavo turgidus, coriaceus. Loculi 4 seu 5 pulpo sapido farcti, dissepimentis interjacentibus tenuissimis ramentaceis. Receptacula nulla. Semina solitaria, oblonga, compressa, hinc obtusa, inde angustiora, sinu hinc extremitatem versus crassiorem excavata. Integumentum duplex: exterius membranulis intertextis pulpo repletis farctum; interius tenue, semini adhærens. Seminis substantia alba, carnosâ, firma, in qua nullam ferruminationem, embryonem, radiculam, neque aliam ullam partium divisionem perspicere possum.

Arbor Mundo dicta, p. 135.

Rumphius, in the text, considers the Mundo as the same with, or at least very nearly allied to, the Panitsjica of the Hortus Malabaricus (iii. 45), which Burman in his observation on the Mangostana (p. 134 *ad initium*) considers very nearly allied to that tree, and the same with the Man-

gostana celebica. Burman is certainly wrong, for there can be no doubt, I think, that the Panitsjica is a Diospyros, which Gærtner, mistaking the position of the calyx, called Embryopteris. Further, what Rumphius states concerning the juice of the Mundo, which he says is yellow, is by no means reconcilable with the Panitsjica, the juice in the unripe fruit of which is, as Rheede expresses it, "humor glutinosus aqueo pellucidus." I am, however, inclined to think, that the Mundo, although quite different from the Panitsjica, is really of the same genus with the *Mangostana celebica*; for I know a tree, which I take to be the Mundo, and which Dr Roxburgh for some time took to be the *Garcinia celebica*, but which, on farther consideration, he called *Garcinia pictoria*. I found it in a garden at Barui-pur, where it probably had been imported from abroad, and sent it to Dr Roxburgh in 1799. I also sent a description and drawing to Sir J. E. Smith, coloured with its own gum, that is, the flowers were coloured entirely with this substance, while indigo was added for the green parts. This pigment is, however, very different from true gamboge, being less readily soluble in water, and its colour remaining unchanged when mixed with potass. I am inclined, however, on account of this yellow juice, to think, that this is the Kanna Gorakha of the Cingalese, or the Carcapuli of Linscot, which Caspar Bauhin, and after him Burman (Thes. Zeyl. 27), Linnæus (Fl. Zeyl. 195), and the Compiler of the Encyclopedie (iii. 701), confounded with the Carcapuli of Acosta, or Gorakha of the Cingalese, as Hermans, in a letter to Syen (Hort. Mal. i. 42), clearly points out. Although Burman says (Thes. Zeyl. 28) that the fruit of his plant has only four seeds, and although this number of seeds is found in what I have called *Oxycarpus gangetica*, and a greater number in that which I am now describing, yet the juice of the *Oxycarpus gangetica* is not

a yellow pigment; and the number of seeds, owing to abortion, is very variable, a circumstance little attended to by many of the older botanists. I have, at any rate, very little doubt that the *Garcinia tinctoria* of Dr Roxburgh is the *Oxycarpus indica* of the Encyclopedie (Sup. iv. 257), although the Compiler says that the hermaphrodite-flowers are solitary. This, indeed, is sometimes the case in the plant which I saw; although, in more perfect specimens, three, or even five, flowers at the end of the branch are more common. The flowers are also said by the Compiler to be small; but this is by no means the case with the tree seen by me, and which I shall therefore describe, as being the *Mundo*.

Arbuscula erecta ramis confertis, lævibus, deflexis. Folia opposita, petiolata, lanceolato-oblonga, integerrima, acuminata, glabra, venosa, plana, pollices quatuorlonga, sesquipolicem lata. Petiolus compressus, supra planus, marginatus, brevissimus, glaber, estipulaceus.

Flores dioici polygami, magni, flavi, terminales, fasciculati, squamis vagis ovatis obtusis concavis brevibus bracteati. In masculina arbore fasciculus justus constat e pedunculo centrali trifloro, cum lateralibus unifloris sex, sed flos unus vel alter sæpe deficit; in hermaphrodita arbore justus fasciculus habet pedunculum centralem uniflorum cum duobus vel quatuor lateralibus, sed laterales aliquando deficiunt.

M. Calyx tetraphyllus, coloratus, foliolis subrotundis, concavis, obtusis, patulis, alternis majoribus carinatis. Petala quatuor, assurgentia ovalia, carnosæ, calyce duplo longiora margine tenuissimo reflexo. Filamenta plurima, crassa, brevissima, receptaculum undique tegentia. Antheræ clavatæ, tetragonæ. Pistillum nullum. Receptaculum superum, maximum, convexum, quadrilobum.

H. Calyx et corolla ut in masculinis. Filamenta quatuor, petalis alterna, brevia, 3-7-fida, ramis antheriferis. Antheræ oblongæ, nescio an fertiles! Germen subrotundum, magnum, superum, striis depressis 9-12 notatum, 9-12 loculare. Stylus brevissimus. Stigma maximum, peltatum, 9-12 lobum, lobis laceris.

CAPUT XXXIX.

Anona, p. 136, t. 45.

Rumphius considered this as the same with the Anona *Maram* of the Hortus Malabaricus (iii. 23, t. 30, 31); and the elder Burman, in his observation on this chapter, although he admits that the figures are somewhat different, persists in the same opinion, adding, as synonymous, the Anona *maxima*, “foliis oblongis angustis, fructu maximo, luteo, conoide, cortice glabro, in areolis distincto” of Sloane, which is the Anona *Oviedi* of Clusius, Parkinson, and J. Bauhin, and which is also quoted by Catesby and Ray for a plant described by them. Burman also added as synonymous the Anona *indica angustifolia*, “fructu cœruleo, cortice squamato glabro” of Plukenet (Alm. 32; Phyt. t. 134, f. 4). Now, I see no very great objection to the first set of synonyma, although Rumphius alleges, that the plant of Oviedo differs much from his; but the plant of Plukenet, having a blue scaly fruit, cannot be that of Rumphius, having a yellowish or reddish fruit, like a pomegranate in colour. The plant of Plunkenet may, however, be the same with that of the Hortus Malabaricus, of which “fructus non, uti Atamaram, e compactile lignosarum squamarum strue compositi, sed undique glabro, hyacinthino ac tenui nitente cortice obducti sunt.” If by this Rheede means that the fruit is purple, like a hyacinth, such a plant is totally unknown to me. In other respects, his account of the fruit agrees very well with that of a plant very common in India, and which I take to be the Anona of Rumphius, although I must confess that its fruit does not exactly resemble either that delineated in the Herbarium Amboinense, or Hortus Malabaricus; nor do the figures of the fruit, in these two works, resemble each other.

It must also be observed, that Rumphius himself doubted of his plant being the same with the Anona of Oviedo, which Plukenet says (Alm. 32) is the Cachima of the Caribbæan Islands, that is, the *Anona muricata*.

When the elder Burman published his *Thesaurus Zeylanicus*, he considered it likely (21) that the plant of Rumphius is the same with the *Anona sylvestris* of Herman, or Ahughas of the Ceylonese (misprinted Alughas in Burman, a way of spelling carefully since copied), an indigenous plant, now called *Anona asiatica* (Willd. Sp. Pl. ii. 1267); but since Linnæus first introduced the species (Fl. Zeyl. 225), several synonyma have been added, and especially the *Guanabanus fructu purpureo*, an American plant, very possibly the same with the Anona of the Hortus Malabaricus. I must admit, that the plant, which I consider as the one meant by Rumphius, is chiefly found about villages, and may therefore perhaps be an exotic, while the name Nona, by which it is usually called in the Gangetic provinces, savours much of being derived from Anona, a Mexican word, as Rumphius alleges: yet the plant, according to him, differs so much from the descriptions of the American Anona, that I am inclined to think it indigenous, and that it may be the *Anona asiatica*, as constituted by Linnæus (Fl. Zeyl. 225). This I judge to be the case, the more especially, because it is much more generally diffused than the *Anona squamosa*, no doubt an American plant; while its fruit is execrable, and totally unworthy of transportation, and that of the *Anona squamosa* is delicious.

However this may be, Linnæus, in the *Species Plantarum*, under the name *Annona reticulata*, joined the plant of Rumphius with the West Indian plant already mentioned; and if they be different, which I think probable, I cannot say which he really meant. He took no notice of

the *Anona* of the Hortus Malabaricus, deterred probably by the figure of the fruit, which is not *reticulata*, but *imbricata*.

In the Encyclopedie, the plant of Catesby alone was joined with that of Rumphius, and annexed to the *Anona reticulata* of Jacquin, to form the *Anona reticulata* α , while the plant of Sloane, notwithstanding the difference in the colour of the fruit, was joined with the *Anona* of the Hortus Malabaricus, to form the *Anona reticulata* β ; and an observation is made, that the latter seems nearly allied to the *Anona asiatica*. So far the author is certainly right, that the *Anona* of Rumphius has an undoubted claim to be preferred to the name *reticulata*, having been mentioned as such by Linnæus.

Soon afterwards Willdenow divided, in a similar manner, the *Anona reticulata* into two varieties; but, according to him, the first is the plant of Jacquin, united with that of Sloane, Catesby, and Ray, with that of the Hortus Malabaricus, and with a new synonymon from Plumier, *Guabanaus fructu aureo et molliter aculeato*, which, even from this short character, seems different from either the plant of Rheede or that of Rumphius. The second variety joins the *Anona* of Rumphius with the *Anona mucosa* of Jacquin (considered in the Encyclopedie as the *Anona glabra*), and excludes all other synonyma.

In the Hortus Kewensis (iii. 334), the *Anona* of the Hortus Malabaricus alone is quoted for the *Anona reticulata*, and no notice is taken of the *Anona* of Rumphius. Amidst such confusion I do not wonder at neither being quoted in the Hortus Bengalensis; but the plant which is there (p. 23) called *Anona reticulata*, is that which I have considered as the *Anona* of Rumphius, although I must admit, that our plant agrees much better with the description of Rumphius than with his figure; for I have never

seen its fruit reticulated in any manner like what this represents.

I may venture to say, that there are only two species of *Anona* in any manner common in the gardens of India. The one is the plant which will be next mentioned, about which there is no difficulty. The other is the *Nona* of the Gangetic provinces, called *Anona reticulata* by Dr Roxburgh, which entirely agrees with the description of Rumphius; and, notwithstanding the figure of the fruit in this author has no resemblance to that of our plant, I think he meant no other; and I strongly suspect, notwithstanding the differences both in the figure and description given in the *Hortus Malabaricus*, that the same plant is there meant, and that Rumphius was right in considering his *Anona* and that of Rheede as the same. I am also inclined to think that this is indigenous, and that we have no American *Anona* common in India, except the *squamosa*. I am not, however, by any means clear that Burman was right in considering the Indian *Anona* as the same with the *Anona asiatica* of Linnæus. I never heard of its root being used as a dye; and, on this account, I have some suspicion that the Ahughas (Lin. Fl. Zeyl. 225), or *Anona asiatica*, is a *Morinda*. In the forests, however, bounding Bengal on the east, there has been found another indigenous species of *Anona*, named *Suriffa* by Dr Roxburgh (*Hort. Beng.* 43), which may be the *Anona asiatica*, although I suppose it to be rather the *Khi* of Rumphius, to be immediately mentioned.

Anona mas, p. 137.

Perhaps our *Anona*?

Fructus chinensis Khi dicta, p. 137.

This is perhaps the *Anona fructu rubicundissimo* of Linnæus (Fl. Zeyl. 509) and Burman (Thes. Zeyl. 21), excluding all the synonyma of American plants. It may, however, more likely be the *Anona sariffa* of Dr Roxburgh, the plants of Southern China having a great affinity with those from the north-east of Bengal.

CAPUT XL.

Anona tuberosa, p. 138, t. 46.

There can be no doubt that this and the *Ata Maram* of the Hortus Malabaricus (iii. 21, t. 29) are the same, and that they are the *Anona squamosa* of Linnæus, and subsequent authors. Notwithstanding what Plukenet says (Alm. 32), this is what the English abroad call Custard-apple; nor either in the East or West Indies did I ever hear it called Sweet Sop, as the Hortus Kewensis alleges (iii. 334) on the authority of Plukenet (Alm. 32). It is indeed impossible that any person could compare the fruit of our other species of *Anona* to a custard, or any thing tolerable. The Sweet Sop, in Jamaica at least, I believe to be the *Anona muricata*, called Cachiman in the French Islands.

CAPUT XLI.

Cujavus domestica, p. 140, t. 47.

CAPUT XLII.

Cujavus agrestis, p. 142, t. 48.

Since the time of Linnæus, the former of these has been called *Psidium pyriferum*, and the latter *P. pomiferum*; and Willdenow has placed no less than four species between them: but there is no real difference of species, in

the sense usually adopted by botanists, the two plants differing much less than many kinds of Apple (*Pyrus malus*). Dr Roxburgh (Hort. Beng. 37) did not distinguish them by the form, but by the colour of the fruit, calling those *Psidium pyriferum* which have a white fruit, and those *P. pomiferum* which have a red fruit. This, however, does not appear to have been the distinction of Rumphius, who considered the kinds that are acid, and approach the crab or unimproved plant, as the *Cujavus agrestis*; and the kind with a sweet fruit, much improved by cultivation, as the *Cujavus domestica*. There are a great many varieties, of both colours and forms, that have an excellent flavour, and must be considered as belonging to the latter. In India, although an exotic, the *Cujavus agrestis*, like the *Pyrus malus* in Scotland, has become a perfect forest or wood tree, the seeds having been scattered by birds, as they powerfully resist the organs of digestion.

Cujavus silvestris, p. 144.

Probably a variety of the *Cujavus agrestis*.

CAPUT XLIII.

Cujavillus, p. 145, t. 49.

Burman, in his *Flora Indica* (114), called this *Psidium cujavillus*; but it was unnoticed by Linnæus. The Compilers of the *Encyclopedie* received from M. Sonnerat specimens of a plant, which they called *Psidium angustifolium*, as synonymous for which they quoted the *cujavillus*, with, however, some doubt. Vahl, as usual, changed the name of Burman into *Psidium pumilum*, quoting, without hesitation, the *cujavillus* for the plant he meant. Willdenow prefers the name of Vahl to both that of Burman and that

of the Encyclopedie, and quotes both without any doubt of the plants they describe being the same; yet I suspect that the plant of Rumphius is not different from the *Psidium decaspermum* of Willdenow (Sp. Pl. ii. 958), which Forster considered as a distinct genus, in which he is supported by Gærtner, the former calling it *Decaspermum fruticosum* (Gen. Nov. N. 37), and the latter *Nelitris jambosella* (De Sem. i. 135, t. 27, f. 5).

CAPUT XLIV.

Papaja Mas et Femina, p. 145, t. 50, 51.

Ever since the time of Linnæus this plant has been called *Carica papaya*; nor does any commentary seem to be required.

Papaja silvestris, p. 149, t. 53, f. 1.

This is quoted by Willdenow (Sp. Pl. ii. 549) as the *Bergera Koenigii*; but I agree with the Compiler of the Encyclopedie (Sup. i. 620) in thinking them very different plants. From the description of the fruit in Rumphius, “post flosculos sequuntur fructus, qui pallidæ et rotundæ sunt baccæ, minores granis Oryzæ, superius planæ, ibique formantes coronulam ex quinque filamentis reflexis compositam, ac ipsis baccis plane incumbentibus, in qua albicans siccaque locatur medulla in quinque loculos divisa,” I infer, that the fruit is “bacca pentasperma, calyce pentaphyllo coronata;” which, together with its habit, persuades me that the plant belongs to the order of the Araliæ.

Papaja litorea, p. 150, t. 52.

This also seems evidently to me to be a plant of the order of Araliæ, and M. Poiret (Enc. Meth. v. i.) considers it as a species of *Panax*; but this seems doubtful, as no-

thing is said in Rumphius, the only authority, to enable us to determine its genus.

Papaja Atehu, p. 150, t. 53, f. 2.

This also is evidently one of the *Araliæ*; and, if it has really eight petals, as Rumphius says, it is probably a *Gastonia*; but it is possible that his "octo petala" may include the divisions of the calyx, as well as those of the corolla.

CAPUT XLV.

Lansium domesticum album et rubrum, p. 151,
t. 54.

Mr Correa, according to the *Encyclopedie* (Sup. iii. 299), considers this as nearly allied to the *Cookia*, in which I entirely coincide. It differs from the *Cookia* in having the seeds covered by a succulent arillus. It seems also to have a considerable affinity with *Nyalel* of the *Hortus Malabaricus* (iv. 37, t. 16); which, however, has its flower divided into five, and only two seeds in each berry. The two kinds mentioned by Rumphius seem such varieties as occur in all cultivated plants.

CAPUT XLVI.

Lansium silvestre primum et secundum, p. 153,
t. 55.

Rumphius gives no mark, except the colour of the wood, by which these trees could be distinguished, and this will scarcely be accepted by botanists: nor does he mention to which his figure belongs.

Lansium montanum, p. 154, t. 56.

No reference is made to this plant by any author that I know.

CAPUT XLVII.

Cussambium, p. 154, t. 57.

In the observation annexed to this chapter, Burman compares the Cussambium to the Pongam of the Hortus Malabaricus (iv. 73, t. 35). The Compilers of the Encyclopedie (ii. 235) admit a certain resemblance, but point out the remarkable difference in the structure of their fruits. I must say that I see no resemblance; for the leaves of the Pongam are simple, and those of the Cussambium are pinnated: the former probably belongs to the Urticæ, and the latter to the Terebintaceæ. I have found the name Kusam very widely diffused in India, and applied in Kankana in the southern peninsula, and in Magadha on the Ganges, to trees like the Cussambium, having a very hard heavy timber, alternate abruptly pinnated leaves, small flowers disposed in racemes, and a drupa containing one nut. This genus approaches to the Schinus, but the structure of the drupa is very different, the nut almost entirely resembling the Koon of Gærtner (De Sem. ii. 486), which he takes to be an Ochna; but, as he never saw the nuts united, we may suspect a mistake. Besides the plant of Rumphius, which I have not seen, I have observed two species of this genus, and I thus distinguish the three:

1. *Cussambium spinosum* drupis spinulosis, Herb. Amb. i. 157, e Rumphii Actuario.

Cussambium, Herb. Amb. i. 154, t. 57.

Habitat in India aquosa.

2. *Cussambium glabrum*, drupis inermibus, foliis glabris Linkeng, Herb. Amb. i. 157. ?

Kusam Hindice.

Habitat in sylvis Magadhæ.

Arbor elata ligno duro, utili. Ramuli nudi, cicatricibus obcordatis obtusangulis exasperati. Folia alterna, decidua, abrupte

pinnata; foliola sæpius trijuga, opposita, sessilia, oblonga, obtusiuscula, nuda, integerrima, costata, venis minute reticulata, latere anteriore basin versus angustato obliqua, superioribus longioribus. Petiolus basi incrassatus, brevis, nudus, teretiusculus. Rachis teretiusculus, nudus, non mucronatus. Stipulæ nullæ.

Flores dioici. In masculina racemi axillares vel infrafoliacei, folio breviores, erecti, pedunculati, aliquando ramosi rachi pubescente angulato. Pedicelli 3—4-flori, brevissimi. Flores virides, parvi.

Calyx quinque-partitus, minimus, fundo tectus disco carnosissimo maximo. Filamenta 7 vel 8 pilosa, disco inserta, calyce multoties longiora. Antheræ magnæ, oblongæ, quadrisulcæ. Germen nullum. Styli rudimentum in floris centro.

Fœmininam arborem florentem non vidi.

Drupa rudis, inermis, magnitudine Cerasi utrinque acuta, cortice crasso fungoso. Arillus duplex: exterior membranaceus, tenuis; interior succulentus, edulis, crassus, e basi seminis enatus, semen totum tegens, apice lacerus. Nux basi derasa, lævis, obovata, compressa, monosperma. Integumentum membranaceum. Semen incurvum, teretiusculum, septum dimidiatum e basi testæ enatum amplexans. Albumen nullum. Embryon incurvum: radícula infera; cotyledones magnæ semiteretes, exteriore crassiore.



3. *Cussambium pubescens* drupis inermibus, foliis pilosis,
Koon Gært. De Sem. ii. 486. ?

Shaguda, Kiandalay, vel Shandalay Carnatæ.

Kussum Cancanæ.

Habitat in Indiæ australis sylvis.

Arbor mediocris ligno duro. Ramuli obtusanguli, pubescentes. Folia decidua, alterna, abrupte pinnata. Foliola opposita, 2 vel 3-juga, oblonga, sessilia, integerrima, costata, venosa, pilosa, ima brevia, subovata, obtusa cum acumine brevi; superiora elongata, latere inferiore longiore latiore obliqua, retusa cum acumine. Petiolus basi incrassatus, obsolete trigonus, pilosus, estipulaceus, mediocris. Rachis utrinque sulcatus.

Flores parvi virides dioici.

Hermaphroditæ arboris paniculæ infrafoliaceæ, longitudine foliorum decompositæ, pedicellis fasciculatis. Florum fasciculi squamula suffulti.

Calyx quinque-partitus, minimus, fundo tectus disco carnosissimo. Filamenta 6—10, sæpius 8, pilosa, disco inserta. Antheræ bilobæ, nescio an fertiles? Germen superum, subpedicellatum, longitudine staminum. Stylus subulatus. Stigmata duo vel tria, crassa, pubescentia, revoluta.

Maris paniculæ folio breviores, compositæ e racemulis brevissimis 4—6-floris. Pedunculus angulatus, pilosus.

Calyx ut in hermaphrodita. Filamenta 7—8, pilosa, subulata, patentia, calyce multo longiora. Antheræ magnæ, oblongæ, quadrisulcæ. Germen nullum. Styli rudimentum simplex in disci medio.

Linkeng, p. 157.

This seems evidently to be a *Cussambium*, very nearly allied to my *C. glabrum*, above described, if it be really different; but being cultivated, its fruit is probably more succulent than that which grows wild in India, although this also is esculent.

CAPUT XLVIII.

Pomum draconum domesticum, p. 157, t. 58.

This seems pretty clearly to be a *Spondias*, but it is not mentioned by any recent author, so far as I know.

CAPUT XLIX.

Pomum draconum silvestre, p. 159, t. 59.

This also seems to be a *Spondias*.

Rau Genrang, p. 159.

Seems to be still another *Spondias*.

CAPUT L.

Condondum, p. 161, t. 60.

In a commentary on the First Part of the *Hortus Malabaricus*, I have explained several errors that have arisen

from that of Rumphius in confounding the Condonum with the Ambalam, and from the erroneous synonyma given in the observation of Burman. While the Ambalam is clearly a Spondias, I have little doubt of the Condonum being the *Mangifera pinnata* of the younger Linnæus, of which I have presented a specimen to the Company's collection.

CAPUT LI.

Condonum Malaccense, p. 162, t. 61.

Whether or not this be the same with the *Cat ambolam* of the Hortus Malabaricus (i. 93), as Burman in his observation asserts, I cannot say, as the account of the *Cat ambolam* is remarkably imperfect; but the plant here described by Rumphius seems clearly to belong to the same genus with the *Mangifera pinnata*, quite different from a Spondias; nor can I perceive any thing, except the leaves, to distinguish the Condonum from the *Mangifera indica*.

CAPUT LII.

Cynomorium, p. 163, t. 62.

This was called Cynometra by Linnæus, and subsequent authors have adopted the same name, although not a little objectionable.

CAPUT LIII.

Cynomorium silvestre, p. 167, t. 63.

Linnæus, following the observation of Burman, joined this with the Iripa of the Hortus Malabaricus (iv. 65, t. 31), to form the *Cynometra ramiflora*; and as usual has been followed, without comment, by more recent writers. I am very doubtful, however, concerning the identity of

these plants; for the leaves are described by Rumphius as very acute, “*folia longiora, magisque acuminata;*” while those of the *Iripa* are blunt, “*oblongo-rotunda;*” and, in the figure, appear as if even retuse. In Ava I found a tree called *Mræn-ga*, which agreed with the specific character of the *Cynometra ramiflora*, as given by Linnæus; but I did not compare it with the figures and descriptions of the two great Indian botanists. Specimens, however, were transmitted to Sir Joseph Banks, and may serve to throw more light on the subject.

CAPUT LIV.

Sandoricum domesticum, p. 167, t. 64.

The Compiler of the *Encyclopedie* (iii. 69), copied by Willdenow (*Sp. Pl.* ii. 556), quoted this, with doubt, as being the same with the *Hantol* of Camelli and Ray, which the French botanist called *Sandoricum indicum*; but it must be observed, that the figure of Rumphius represents the flower without any thing like the cylindrical nectarium, which in the *Hantol* supports the antheræ. No great stress can, however, be laid on this circumstance.

Sandoricum silvestre, p. 168.

Whether this is a distinct species from the preceding, or whether it is merely the plant in an uncultivated state, I cannot take upon myself to determine, although I think that I have seen the plant in Pegu; but unfortunately, like the specimen of the *Sandoricum indicum*, which the French botanist procured, the trees which I found were in fruit. In the language of Ava it is called *Sit-to*, and specimens were sent to Sir Joseph Banks. At the time I considered it as nearly allied to the *Cratæva tapia*, which, with

Dr Roxburgh, I then called a *Capparis*. The following note I took on the spot.

Arbor ramis teretibus, pubescentibus, fuscis, elevato-punctatis, sulco e petiolorum basi decurrente utrinque exaratis. Folia maxima, alterna, petiolata, ternata; foliola petiolata, integra, integerrima, supra nitida, subtus tomentosa, venis reticulata, plana; lateralia oblonga, acuminata, ad basin posterius gibbosiore; terminale latius, obtusum. Petiolus communis mediocris, basin versus incrassatus, apicem versus semiteres, pubescens: partialium laterales brevissimi; terminalis mediocris, teres, utrinque incrassatus. Stipulæ nullæ.

Pedunculus fructiferus axillaris, solitarius, fructu terminali indivisus, rudimentis quasi flosculorum abortivorum plurium lateralium notatus. Bacca supera, calyce deciduo nudata, globosa, striata, corticosa, unilocularis. Nuciculæ quinque pulpo filamentoso arillatæ.

From this it would seem that it differs from the description of Willdenow, in having the flowers disposed in undivided racemes, or perhaps spikes, while his plant has panicles.

Cajim-gulur, p. 168.

This may be another *Sandoricum*.

CAPUT LV.

Gajanus, p. 170, t. 65.

By Thunberg and Willdenow (*Sp. Pl.* ii. 604) this was considered as the *Inocarpus edulis* of the younger Linnæus; but the Compiler of the *Encyclopedie* (ii. 576, and iii. 253), on account of the form of the fruit, as represented by Rumphius, doubted of the accuracy of this quotation, and considered the tree as related to the *Aleurites*, or *Euphorbiæ*. On farther consideration, however, it would seem that the Compiler was satisfied of the quotation having been proper, as he repeats it in the *Supplement* (iii. 151).

I must notwithstanding say, that the figure of Rumphius has little or no resemblance to that of the *Inocarpus edulis* given by Gærtner (De Sem. iii. 114, t. 199, 200), and still less to that given in the Encyclopedie (Ill. Gen. t. 362). I suspect therefore some mistake, and this perhaps in the figure of Rumphius, which in some respects does not agree with his description; for he says of the fruit, “forma lunæ crescentis,” which agrees somewhat with that of Gærtner, but by no means with that in the Herbarium Amboinense. Burman in his observation seems totally wrong in comparing either description or drawing to the Tani of the Hortus Malabaricus (iv. t. 10), which is no doubt a *Terminalia*, or *Myrobalanus*.

CAPUT LVI.

Atunus, p. 171, t. 66.

The Compiler of the Encyclopedie (i. 329), in mentioning this tree, does not venture to point out its place in the system. If it belong to the same genus with the *Atunus litorea* (iii. 95), I suspect that it may be a *Niota*, as I shall endeavour to point out on a future occasion.

Atun Puti, p. 172.

This has pinnated leaves, while the preceding tree has them simple. They probably therefore belong to different genera.

CAPUT LVII.

Vidoricum domesticum, p. 173.

Vidoricum silvestre primum, p. 173, t. 67.

These trees probably belong to the same genus; and if Gærtner (De Sem. ii. 105) is right in considering the Vi-

doricum *sylvestre secundum* (Herb. Amb. iii. 184) as a *Bassia*, these also may belong to the same genus, although they also strongly resemble the genus *Diospyros*; but to this subject I shall again have occasion to return. I need scarcely mention that Burman, in his observation on this plant, is totally wrong in considering it as of the same genus with the *Caniram* of Rheede (Hort. Mal. i. 67, t. 37), which is the *Strychnos nux vomica*.

CAPUT LVIII.

Catappa domestica, p. 174, t. 68.

Why Linnæus chose to give the name *Terminalia* to the genus to which this tree belongs, Rumphius having previously applied it to a totally different plant; and why, still farther, he did not give even the specific name *catappa* to the same tree that Rumphius called so, κατ' ἐξοχην, I cannot say; but this is not the *Terminalia catappa*, nor does Linnæus seem ever to have seen it. M. Lamarck (Enc. Meth. i. 349) seems first to have introduced it into the modern system of botany, under the name of *Terminalia moluccana*, a name properly retained by Willdenow (Sp. Pl. iv. 968), although Forster had called it *Terminalia glabrata*; and Dr Roxburgh, probably in a private communication to Willdenow, had given it the name of *Terminalia glandulosa*. My worthy friend, however, before his death, adopted the name of Lamarck (Hort. Beng. 33).

Catappa litorea, p. 175.

Seems also no doubt to be a *Terminalia*.

Catappa silvestris, p. 175.

This, I have little doubt, is the *Terminalia catappa* of botanists, the *Ada maram* of Rheede (Hort. Mal. iv. 5),

because Rumphius states as follows:—"Oræ foliorum angustatæ fere ad petiolorum ortum, qui obducti quoque sunt tenui, rufa, et molli lanugine, quali itidem ramuli virides surculique obteguntur." The kernel, however, in the plant of Malabar, probably from cultivation, is superior in size to what it would appear to be in the wild plant of the eastern islands, fully equalling what Rumphius describes that of the *Catappa domestica* to be. The leaves, so far as I have observed, are quite entire, so that the only difference between the plants of Malabar and Molucca arises from the leaves of the former being hairy beneath, while in the latter they are smooth. The resemblance to this fruit mentioned by Plukenet (Mant. 156, cum Alm. 306 collata) appears to me far-fetched, and, notwithstanding the author's prudery, could only have arisen from a prurient imagination.

CAPUT LIX.

Cassuvium, p. 177, t. 69.

This plant, originally a native of America, has now spread itself, through most warm countries, in sandy places near the sea; but, in India at least, is seldom found in other situations. Its original name, Acajou, variously written and corrupted, seems to have followed the tree everywhere, and is known in Old India, the Eastern Archipelago, and China. The name Kapa Mava, given to it in the Hortus Malabaricus (iii. 65, t. 54), I never heard among the natives of Malabar, and suspect some mistake in Rheede.

Caspar Bauhin considered this tree as of the same genus with the *Anacardium* of the East, and therefore most properly called it *Anacardii alia species*. Linnæus, who knew no other kind, in imitation of Bauhin, called the West Indian plant *Anacardium occidentale*; but his son, having

obtained the original *Anacardium* of the East, and, finding some slight difference in the number of the sexual parts, made it a distinct genus; while, in place of reserving for this the name *Anacardium* given to it by the earliest botanical writers, he called it *Semecarpus*. Although this nomenclature is adhered to by Willdenow (Sp. Pl. i. 1476, et ii. 486), and many other most eminent botanists; yet, if the plants are to be considered as belonging to different genera, I must prefer the nomenclature adopted by Lamarck, followed by Jussieu and other French writers, who have restored the name of Rumphius to the *Anacardii alia species* of Bauhin, and the name *Anacardium* to the plant originally so called. As, however, I consider that both plants belong in fact to the same genus, I would call the former *Anacardium cassuvium*, and the latter *Anacardium semecarpus*.

CAPUT LX.

Cassuvium silvestre, p. 179, t. 70.

Willdenow does not quote this plant; but in the *Encyclopedie* (i. 140) it is considered as a variety of the *Anacardium longifolium*, which Willdenow calls *Semecarpus anacardium* (Sp. Pl. ii. 1476). Dr Roxburgh, on the contrary (*Hort. Beng.* 22), having procured plants from the Moluccas, considered it as a distinct species, which he called *Semecarpus cassuvium*; nor, indeed, did Rumphius suppose that his plant was the *Anacardium* of the shops, the nuts differing very considerably, in shape at least, being reniform in the *Cassuvium silvestre*, while in the *Anacardium orientale* they are ovate, with a slight notch, on one side, under the point, which is oblique.

In India there is still another species very nearly allied to the *Anacardium orientale*, and in fact confounded with it by the natives under the common name Bhela of the

Hindwi and Bengalese languages, and Sæn-bho Sa-ræk in that of Ava. This want of distinction is of no great consequence, as both species possess the same qualities; nor in this respect would the plant of Rumphius appear to differ in any material point. I shall, however, give an account of this third species, hitherto little known, although in the woods of Gangetic India it is a very common tree.

Anacardium cuneifolium foliis obovatis, subtus tomentosis.

Semicarpus cuneifolium, Hort. Beng. 22.

Anacardium latifolium, Enc. Meth. i. 139. ?

Habitat in sylvis Avæ et Indiæ Gangeticæ.

Rami teretes, pubescentes, cicatricibus magnis notati. Folia alterna, sæpe sesquipedem longa, obovata, basi acutiuscula, apice obtusissima, immo aliquando retusa, integerrima, costata, venis minutissime reticulata, subtus albido-tomentosa, supra pilosa, rigida. Petiolus brevissimus, semiteres, pubescens. Stipulæ nullæ.

Arbores dioicæ. Masculinæ panicula terminalis, vasta, foliis longior, ramosissima, divaricata. Rami obtusanguli, pubescentes. Bracteæ obtusæ, parvæ, planæ, ad paniculæ ramificationes adnatæ. Flores parvi, viridescentes, fasciculati, vix pedicellati.

Calyx minimus, quinque-partitus. Petala 5, calyce majora, ungue lato patentia, obtusa. Filamenta 5 petalis alterna, hisque paulo longiora. Antheræ subrotundæ. Germinis in calycis fundo rudimentum pilosum, quinquesusulcum.

Fœmininæ arboris flores non vidi.

Receptaculum fructus turbinatum, pulposum, crassitie brevius sua. Nux erecta, oblonga, compressa, receptacula longior sed angustior, oblique mucronata, latere rectiore apicem prope emarginato.



Anacardium cuneifolium.



Anacardium semecarpus.

CAPUT LXI.

Gnemon domestica mas, p. 181, t. 71.

Gnemon domestica femina, p. 181, t. 72.

Botanists have usually quoted these as forming only one species; and, as the tree is cultivated, and thence probably assumes different appearances, this may be the case, the male and female kinds, as Rumphius calls them, being what recent botanists call varieties: for they are not, as Jussieu supposed, the male and female of a dioicious plant, as both produce fruit. Burman, in his observation on this plant, has confounded it with the *Mala elengi* of the Hortus Malabaricus (v. t. 55), which I consider as being a *Chionanthus*. Linnæus, taking *Gnemon* for a specific appellation, called it *Gnetum*, in which he has been followed by subsequent writers, although I am at a loss to know from whence he took the word. The synonyma quoted by Rumphius himself are more correct than those given since, this plant having been brought early into notice by Sir Francis Drake, who found it on the island Beretina, from whence it was called *Fructus beretinus*. It was afterwards introduced into the botanical system by C. Bauhin, under the name of *Laurifolia terenatensis*; and it seems surprising that these synonyma should not have been quoted by moderns.

CAPUT LXII.

Gnemon silvestris, p. 183, t. 73.

This is the *Gnetum ovalifolium* of the Encyclopedie (Sup. ii. 810). The plant of the Hortus Malabaricus (v. 51, t. 26) called Mail Ombi or Kombi, which Burman thought the same with this, is probably an *Antidesma*.

CAPUT LXIII.

Morunga mas, p. 184, t. 74.

Morunga femina, p. 184, t. 75.

Some confusion here exists in the account of Rumphius; for he says, “*Flores maris omnes pereunt, nec fructus relinquunt; feminae autem flores excrescunt in ingentem siliquam;*” from which we ought to infer, that the tree is dioicious: but in the plates both male and female are represented as producing fruit; and besides, from their leaves, the plants so called would appear to be different species, although in the description no notice is taken of this difference.

The older botanists noticed only one kind of *Morunga*, as is especially the case with Rheede (*Hort. Mal. vi. 19, t. 11*). Several of these authors noticed the resemblance of this plant to the *Balanus myrepsica*, or Nux Been of the druggists, although in general they mentioned an essential difference in its having winged seeds. Plukenet (*Alm. 253*) commenced a system of error respecting this plant, by considering it as the same with the *Lignum nephriticum* of America, an opinion which the Compiler of the *Encyclopedie* (*Sup. i. 659*) properly rejects; for the wood of the *Morunga* gives no blue colour to water in which it is infused.

The elder Burman endeavoured to establish two species of *Morunga*; the *Morunga mas* of Rumphius he called *Moringa Zeylanica, pinnis rarioribus, flore minore* (*Thes. Zeyl. 164*), distinguished by having only five stamina: while the *Morunga femina* of Rumphius he called *Moringa Zeylanica, flore majore, fructu anguloso* (*Thes. Zeyl. 162, t. 75*), distinguished by ten stamina. The character derived from the number of stamina, could we depend on the accuracy of Burman, would be excellent; but in the plant

so common about the villages of India, although there are ten filaments, five only of them have antheræ, as described by Rheede, “ colus in decem staminula e viridi albula extorsum flexa, divisus, quorum paria (*singula intellige*) uno grandiusculo flavescente obteguntur apice:” and it is possible that Burman may have thought that some of the antheræ had fallen by accident from his specimen, and that in their natural state all the filaments were fertile. I have, however, seen two kinds of this tree, one growing near villages, and the other in woods, and answering to the Wattu (*hortensis*) Murungu, and Katu (*sylvestris*) Murungha of the Ceylonese; and, as I have not seen the flowers of the kind growing spontaneously in woods, it may have only five filaments, as Burman describes. I shall, however, again return to this distinction.

Linnæus, in the *Flora Zeylonica* (155), not only adopted the error of Plukenet, in considering the *Moringa* as the same with the *Lignum nephriticum*; but still farther, he considered it, not only as belonging to the same genus with the *Balanus myrepsica* or *Nux behen*, but as being the same plant, an error from which Plukenet escaped. How Linnæus came to place the *Moringa* in the same genus with the *Bonduc* of preceding authors, I cannot say; as, in my opinion, notwithstanding his eminent authority joined to that of Jussieu, I must agree with Gærtner in thinking that it cannot belong even to the same natural order (*Leguminosæ*), but seems to approach nearer to the *Rutaceæ*; although even this arrangement is not satisfactory, and it seems to belong to a genus rejecting a close affinity with all others.

The error of Linnæus, in joining the *Moringa* with the *Bonduc*s, to form the new genus *Guilandina*, having become evident, Jussieu and other French botanists have most properly restored the name *Moringa* given by John

Bauhin. Neither this, however, nor the still more simple Anoma of Loureiro, has satisfied the modern taste for sesquipedalian Greek, from which Vahl and others have given us Hyperanthera,—a term applied by Forskal to a genus, which I suppose is very different, being really one of the Leguminosæ, with a calyx of one leaf, and a fruit consisting of two valves, to one edge of which the seeds are annexed; while in the Moringa there are three valves, supporting the seeds by their middle. Excluding the two species, which properly belong to the Hyperanthera of Forskal, or to the Gymnocladus of Lamarck, we shall have in Willdenow, as well as in Rumphius and Burman, two species of Moringa. Loureiro has also two species, a Moringa and a Morunga; but the latter, although joined by the Compiler of the Encyclopedie (Sup. i. 391), and by Willdenow, with the Morunga of Rumphius, having opposite leaves, must be a totally different plant. The synonyma, indeed, annexed to the Hyperanthera *moringa* by Willdenow, belong to four, or perhaps rather to five, different plants; and those referred to the Moringa *oleifera* in the Encyclopedie (i. 398), refer to two or three; and I find it impossible to say which of these plants were really meant. Both authors include the two species of Rumphius, to which the Encyclopedie adds a plant of Egypt and Arabia, the *Balanus myrepsica*, or *Glans unguentarius* of old writers (the Moringa *aptera* of Gærtner, De Sem. ii. 315); and Willdenow still farther adds, the American *Lignum peregrinum aquam cæruleam reddens* of Bauhin, by severals called *Lignum nephriticum*, and the Anoma *morunga* of Cochinchina, described by Loureiro, and in the Encyclopedie (Sup. i. 391), as having opposite leaves.

Now, to return to the Morunga *mas et femina* of Rumphius; neither of which, I am persuaded, grows naturally in Egypt nor America, and which, if not distinct species,

as Burman supposed, are at least remarkable varieties. The only reason, I suppose, which Willdenow had for stating that this species belongs to the class Polygamia diœcia, consisting of two different kinds of hermaphrodite plants, was the confounding the two species of Rumphius together. With much more reason he would have referred the *Morunga femina* to his *Hyperanthera decandra*, which, he says, has ten fertile stamina, as Rumphius represents in his figure, and this is the very character by which Burman distinguished it from the *Morunga mas*. In the Supplement to the Encyclopedie this change has accordingly been made; but then the *Anoma moringa* cannot be the *Guilandina moringa* of Linnæus, which is not the *Hyperanthera decandra*, but the *Hyperanthera moringa*.

Like Rumphius and Burman, as has already been mentioned, I have found two kinds of this plant. Perhaps the differences between them arise from the one being cultivated, and the other remaining wild; but this remains to be ascertained: and I am not able to verify whether or not the wild kind be the *Hyperanthera decandra*, as I did not see the flowers. I am by no means satisfied that either is the *Morunga femina* of Rumphius; for I do not think that I have ever seen a species with leaves so regularly bipinnated. I shall, however, mention what I have observed concerning the two species or varieties which I have seen. I reject the specific name *pterygosperma*, given by Gærtner, because he includes both species of Rumphius, and it is impossible to say which he meant.

1. *Moringa domestica* floribus semidecandris, foliis bipinnatis, pinnulis imis aliquando ternatis, foliolis utrinque obtusis nudis, seminibus alatis.

Hyperanthera Morunga, Hort. Beng. 32.

Hyperanthera Moringa, Hort. Kew. iii. 32.

Morunga mas, Herb. Amb. i. 184, t. 74. ?

Mourungu, Hort. Mal. vi. 19, t. 11.

Mitha (dulcis) Sojana Hindice.

Dan-sa-lun Barmanorum.

Colitur ubique ad Indiæ pagos.

Arbor mediocris ramis nudis fragilibus. Folia alterna, bipinnata, pinnularum imarum una vel altera ternata. Foliola oblonga, utrinque obtusa, petiolata, integerrima, subvenosa, nuda, terminali majore obovato. Rachis nudus, supra carinatus, articulatus, ad divisiones incrassatus. Glandulæ pedicellatæ, caducæ, ad singulas folii divisiones supra positæ. Loco stipularum tubercula duo, oblonga, obliqua.

Panicula axillaris, ramis alternis multifloris folio brevior. Bracteæ squamæformes, vagæ, in paniculæ ramos sparsæ. Flores albi, mediocres.

Calyx ultra medium quinquefidus laciniis linearibus, obtusis, coloratis, obliquis. Petala quinque forma et magnitudine laciniarum calycis, calyci inserta. Filamenta decem calyce breviora, declinata, subulata, basi pilosa, alternis longioribus antheriferis inæqualia. Germen pubescens, oblongum, superum. Stylus subulatus, declinatus. Stigma acutum.

Fructus omnino ut capsula Moringæ pterygospermæ a Gærtnero (De Sem. ii. 214) delineata est.

Although I have quoted Rumphius with doubt, because his figure represents the small leaves (foliola) as sharp-pointed, and the leaves as abruptly pinnated, yet every thing he says respecting the growth, cultivation, and uses of the plant, as usual, is excellent, and applicable to the plant I have described. I do not quote Linnæus, the younger Burman, Willdenow, nor the Encyclopedie, because several plants are included by each among the synonyma of the *Guilandina moringa*, or *Hyperanthera moringa*, or *Moringa oleifera*, and it is impossible for me to determine which they really meant. I do not quote either plant of the elder Burman, because his second plant (Thes. Zeyl. 164), which he considers as the same with the *Moringa mas*, is said to have a small flower, which would not appear to be the case with that of Rumphius; nor is it the

case with my plant. Farther, his first plant (Thes. Zeyl. 162) is said to have ten stamina, all of which in the figure are represented as provided with antheræ; and, besides, the figure is a very bad representation of the plant which I have described. I have, however, very little doubt of this being the Wattu or garden Moringa of the Ceylonese, as in every part of India it is the plant most common about villages.

2. *Moringa sylvestris* foliis subtripinnatis, pubescentibus; seminibus alatis.

Katu Murungha Ceylonensium, Burm. Thes. Zeyl. 163?

Tita (amara) Sojana Hindice.

Habifat in Magadhæ sylvis, et rarius ad sæpes plantatur.

Rami, rachides, folia pilosa. Folia subtripinnata, id est pinnularum imæ quinato-pinnatæ, intermediæ ternatæ, superiores simplices. Flores non vidi. Fructus simillimi Moringæ domesticæ.

This tree I have seen nowhere, but near Patna and Mungher. Its fruit is too bitter to be eaten in curries, as that of the domesticated species is; and is used only as a medicine. Having very strong sensible qualities, it probably possesses considerable power on the human body; and was probably that used by the Dutch physicians in Ceylon (Burm. Thes. Zeyl. 164), although some parts of even the cultivated kind would seem to afford a valuable medicine.

CAPUT LXIV.

Turia, p. 188, t. 76.

In a Commentary on the Hortus Malabaricus (i. 93), when treating of the Agaty, I have mentioned the botanical history of this plant, which is the same. As Rumphius says, that the Malabar name is Abati, we may conclude that either Agaty or Abati is a typographical error. In the observation following this chapter, Burman is quite

wrong in considering this as the same with the Kedangu of the Hortus Malabaricus (vi. 49, t. 27), which has flowers not larger than those of the bean (*Faba*).

Turia rubra, p. 189.

This is probably a mere variety, such as usually takes place in plants that are much cultivated. At one time I thought that it might be the *Æschynomene*, or *Coronilla coccinea* (Willd. Sp. Pl. iii. 1146); but that being the *Tæri mera* of Rumphius, is a sufficiently distinct species, which I have never seen. I suspect that in reality Willdenow fell into a similar error, as he says, “simillima præcedenti (*Coronillæ grandifloræ*). Flores ejusdem magnitudinis sed rubri:” but Rumphius, treating of the *Tæri mera*, says, “e rachidis ala petiolus excrescit in binos sese dividens minores, quorum quisque ingentem gerit florem paulo minorem quam præcedentis, id est *C. grandifloræ*.”

Turia striata, p. 189.

This is probably another variety of the same elegant tree, with variegated flowers, not very common in India.

Tæri mera, p. 190, f. 77.

In treating of the *Turia rubra*, I have noticed this plant, which, by Forskal and the younger Linnæus, was called *Æschynomene coccinea*. Burman in his annotation is totally wrong in considering this as the same with his *Emerus siliquis geminatis longissimis* (Thes. Zeyl. 93, t. 41), which, I have little doubt, is the same with the Kedangu of the Hortus Malabaricus, and has not scarlet flowers.

CAPUT LXV.

Olus album domesticum, p. 191, t. 78.

Burman (Obs. p. 192) seems quite right in considering this as the same with the *Bem mænja* of Rheede (Hort. Mal. v. 113, t. 57). The name Naravolo, which, according to this author, the Brahmans of Malabar give to this tree, I found to be the name given in Carnata to a species of *Cordia*, called *angustifolia* by Dr Roxburgh (Hort. Beng. 17); but the two plants seem to have no affinity. It is singular that neither of our two great Indian botanists saw either flower or fruit of this tree. The leaf seems to have some resemblance to the *Acacias folio conjugato pinnato*; but this is all the resemblance that I can trace; and the Compiler of the Encyclopedie, who mentions Rheede's account (Sup. i. 613), gives no conjecture concerning its affinities. Neither is Plukenet, who mentions the tree (Alm. 66), more explicit; and he quotes Ray, who also describes it as producing neither flower nor fruit: but this excellent botanist, in calling the leaves *alata*, supports the opinion of its being an *Acacia*; although what I shall observe on the following plant seems to contradict this opinion beyond a doubt.

CAPUT LXVI.

Olus album insulare, p. 193, t. 79, f. 1.

The leaf of this has still more resemblance to that of an *Acacia* than that of the preceding plant, there being evidently a large gland on the common petiolus; but the description of the flower and fruit seems irreconcilable with this opinion, and the description of Rumphius would seem to imply, in the Linnæan phraseology, "calyx superus, quinquifidus. Petala alba. Stamina octo vel decem. Drupa sicca, ovata, pilosa, venosa."

Utta Pela seu Sajor Bagnala, p. 194, t. 79, f. 2.

Linnæus confounded this with two American plants of the same genus, which Plumier called Plukenetia. These were finally separated by Smith, and the plant of Rumphius is now called *Plukenetia corniculata* (Willd. Sp. Pl. iv. 515; Enc. Meth. Sup. v. 20).

CAPUT LXVII.

Eriophoros Javana, p. 195, t. 80.

Pliny mentions two different plants that contain in their fruit a wool fit for clothing. The one (lib. xii, cap. 10, 11) he calls Arbor *gossampinus*, the other he calls (lib. xix, cap. 1) Frutex *gossipion*, forming thus two natural genera; and as botanists have usually written in Latin, they should have preserved the names thus judiciously given by their Roman precursor. I agree with Rumphius in thinking that the Arbores Gossampini include the *Eriophoros javanica* and several kindred species; while the Gossipion includes the plants now in more common use for producing cotton-wool.

The older botanists, such as C. Bauhin and Plukenet, considered all the plants producing cotton-wool as forming one genus, and preferred the name Gossipion; probably, however, judging themselves better Latinists than the Roman Consul, they changed this name into Gossypium, to which orthography their successors carefully adhere. Tournefort rejects the name altogether, and prefers Xylon, which indeed Pliny mentions as being a more common name than Gossipion, for the shrub bearing wool; and so far, therefore, the French botanist was entirely justifiable; and so might even the older botanists be held, who, considering all the wool-bearing trees as belonging to one genus, gave the classical name Gossypium to the whole.

Linnæus was, I believe, the first to renew the idea of Pliny, in dividing these plants into two genera: but in doing so, while he continued the term *Gossypium* for the Gossipion of the Roman, he bestowed *Xylon*, another term for the same plant, to Pliny's *Gossampinus*. This was in the earliest part of his course, when he published the *Hortus Cliffortianus* and *Flora Zeylanica*. Soon after he seems to have become sensible that the term *Xylon* was ill-applied to the *Gossampinus* of Pliny, and he therefore abandoned it in the first edition of the *Species Plantarum*; but, in place of restoring the name of Pliny, or adopting *Eriophoros* used by Rumphius, or *Ceiba* applied by Plumier to plants of the same genus, he used the word *Bombax*, of which I do not know the origin. It has, however, been adopted by all modern botanists, except Gærtner, who might perhaps have been justified in resuming the *Gossampinus* of Pliny; but the *Bombax* of Linnæus is surely as good as the *Ceiba* of Plumier. Perhaps the *Bombax* of Linnæus should be left to one of the species earliest described by him, the *Bombax gossypinum* or *conga*, which is quite different from the others, does not belong to the same natural order, but rather to the *Tiliaceæ*, and is not an *Arbor lanigera*. In this case, the classical name *Gossampinus* should be restored to the other species of *Bombax*, the authority of Gærtner being scarcely sufficient to introduce *Ceiba*.

Rumphius, and the elder Burman in his annexed observation, seem to have considered the *Eriophoros javanica* as being the same with the *Pania* or *Paniala* and *Moul Elavou* of the *Hortus Malabaricus* (iii. 59, t. 49, 50, 51, et 61, t. 52); but this is evidently a mistake, as the stamina of the *Moul Elavou* distinguish it clearly from the *Eriophoros Javanica*. The *Pania* was quoted by Plukenet (*Alm.* 172) as his "*Gossypium seu Xylon arbor Orientale*

digitatis foliis lævibus, fructu quinqucapsulari, aloa et nitente lanugine farcto;" but unless the figure (Phyt. t. 188, f. 4) be very bad, he must have been mistaken, as it represents numerous stamina; on which account, his plant is quoted by Willdenow for the *Bombax heptaphyllum*, although in other respects it has but little resemblance to that tree. The synonyma, however, which Plukenet gave, probably all belong to the *Pania* or *Eriophorus Javanica*, although he quotes the former erroneously, as if *Pania Paniala* had been one name, an error copied by several subsequent writers.

Linnæus, in the *Hortus Cliffortianus* and *Flora Zeylanica*, endeavoured to distinguish the species of this genus by the presence or absence of prickles on the stem; and indeed Rheedé takes no notice of the prickles on the *Pania*, while he mentions these of the *Moul Elavou*, the very word *Moul* implying prickles. Linnæus, however, soon afterwards learned, that the stems of the younger trees of the *Pania* are prickly, as is stated by Rumphius; and he therefore had recourse to other distinguishing marks, without, however, altering the synonyma, which his former defective characters had induced him to adopt, in considering two American trees as the same with the two plants of Asia, because one had a smooth, and the other a prickly stem.

CAPUT LXVIII.

Bilacus Tellor, p. 167, t. 81.

Into the explanation of either this or the following plate some error has crept. The fruit represented at A is said to be that of the *Bilacus taurinus*, but this again is said to be represented in plate 82. The fruit marked B is said to be the *Bilacus ovalis* or *tellor*, and the fruit C is said

to be that of the *Bilacus minimus* or *Kitsiil*; but no such species is mentioned in the text: and the third kind described there is the *Bilacus Pissang*, which, as Rumphius says, “nomen obtinuit ab oblonga forma instar Musæ Pissangh dictæ;” but the fruit C is shaped like a pear, and cannot represent such a *Bilacus*, as is described. These three fruits, I think, represent three varieties in form of the *Bilacus tellor*, which may indeed be called *maximus*, *ovalis*, and *minimus*; but these are merely such varieties as occur in all cultivated plants; while the *Bilacus taurinus*, if it be represented in plate 82, and *Bilacus Pissang*, are probably distinct species. On this subject, however, I must, for a farther account, refer the reader to the Commentary on the *Bilacus taurinus*.

The *Bilacus tellor* and its varieties were early noticed by botanists under the name Marmelos, corrupted from the Marmeira of the Portuguese, given to it because this people seem to have prepared a marmalade from its fruit; on which account the older botanists compared it to the *Cydonia*, a tree resembling it in no other respect. In the *Hortus Malabaricus* (iii. 57, t. 37) it was described under the name Covalam; but the commentator, Commeline, still adhered to the slight resemblance with the *Cydonia*. Plukenet seems to have been sensible of the absurdity in this comparison; but he was little more fortunate in calling it “*Cucurbitifera trifolia, spinosa, Indica, fructus pulpa Cydonii æmula*,” (Alm. 125; Phyt. t. 170, f. 5). Now his *Cucurbitiferas* include *Crescentia*, *Strychnos*, and other plants equally dissimilar. The elder Burman (*Thes. Zeyl.* 84) continued to class it with the *Cydonia*, but gives the synonyma of preceding writers with sufficient accuracy. In the *Flora Zeylonica*, Linnæus was equally unfortunate with his predecessors, and united this plant with the *Tapia* of Margrave, which he supposed to be the *Niirvala* of the

Hortus Malabaricus (iii. 49, t. 42), to form a new genus, which he called *Crateva*, the *Nirvala* being scarcely distinct from a *Capparis*, while the *Bilacus* belongs to the tribe of *Aurantiæ*. Things respecting the *Bilacus* continued in this state, only the name *Crateva* was changed into *Cratæva*, and the *Bilacus* was called *Bilanus* (Willd. Sp. Pl. ii. 853), until Dr Roxburgh proposed that it should be called *Correa*; but, another plant having obtained this name, the *Bilacus* by Persoon was called *Ægle marmelos*, the appellation that it still retains.

In every part of India this tree is common. The natives of Ava call it Oush-shit; those on the banks of the Ganges, in the spoken dialects, call it *Bel*, corrupted from the *Vilva* of the sacred tongue: but as the fruit is dedicated to the god *Siva*, it is usually called *Sriphula*, or the Sacred fruit. In the *Hortus Bengalensis* it is stated, that a variety, with a small fruit, is the *Sriphula*; and I have often heard the natives distinguish the *Sriphula* from the *Bel*; but on requesting a *Pandit*, attached to my survey, to bring me the *Sriphula*, he brought me a fruit in shape and size exactly resembling that marked *A* in *Rumphius*. The fruit of this tree I shall here describe on the plan of *Gærtner*, and this, I believe, will be new to the European botanist.

Fructus obovatus, magnitudine ovi anserini, lævis, glanduloso-punctatus, odoratus, absque rudimento vel calycis vel stigmatis, apice subumbilicatus, parietibus lignosis crassis unilocularis, farctus pulpo subfarinaceo, fibris paucis intermixto, 10 seu 12 loculari. Loculi verticales, remoti. Semina in singulis loculis quina seu sena, uno super alterum posito, gelatino pauco pellucido tecta, ovalia, magnitudine pisi compressa, pilis longis involuta. Integumentum simplex, membranaceum, crassum, intus politum, ex embryone facile secedens. Perispermum nullum. Embryo forma seminis. Cotyledones crassæ, maximæ, albæ, hinc convexæ, inde planæ. Radicula parva inter cotyledonum margines nidulans, nunc ad extremitatem, tunc versus latera posita.

The kind called Bel by the Pandit was in flower, which was as follows :

Calyx planus, parvus, quadrilobus. Petala quatuor, calyce alterna, oblonga, obtusa, patentia, crassa, ungue lato disco calycino inserta. Filamenta plura, indefinita, ibidem inserta, brevia. Antheræ longitudine filamentorum lineares, quadrisulcæ, acutæ, longitudinaliter ad latera dehiscentes, biloculares. Germen pyramidale, tetragonum. Stylus brevis, teres. Stigma magnum, incrassatum, obtusum.

From this having only four divisions in the flower, if this mark were constant, the Bel may be a distinct species from the plant of Rheede (Hort. Mal. iii. 37), described by Dr Roxburgh, which has five divisions in the flower, and which, the Commentator on the Hortus Malabaricus justly says, is the Sripula (Scrifole) of the Bengalese, as this also has five divisions in the flower; and the same seems to be the case with the Bilacus *tellor*, to judge from the figure.

The fructification of the variety of the Bilacus *tellor*, with the large globular fruit, I thus described in Ava :

Calyx inferus, persistens, planiusculus, quinque vel rarius quadrifidus laciniis ovatis. Petala quinque vel rarius quatuor æqualia, calyce multo longiora, revoluta, coriacea, oblonga, obtusa, sessilia, pellucido-punctata. Filamenta plura, ad basin quinquefariam approximata, hypogyna, subulata, patula, corolla triplo breviora. Antheræ patentia, lineares longitudine fere filamentorum. Germen receptaculo orbiculato insidens, ovatum, octo vel decem sulcis exaratum. Stylus brevissimus, crassus. Stigma clavatum, apice obliquum, umbilicatum. Bacca globosa, parietibus lignosis intus pulpo farcta. Semina plura ovata, plana, sparsa, nidulantia, pilosa.

From this it would appear, that, in this variety, the number of divisions in the flower is not fixed; and I am therefore led to consider, that a proper distinctive character cannot be founded on this circumstance.

Bilacus Madia Pissang, p. 199.

Whether this be a mere variety of the *Ægle marmelos*, or a different species, I cannot take upon myself to say. As I have already mentioned, the fruit C, in table 81, can scarcely have been meant to represent that of this plant, which has a fruit like that of the *Musa*, at least in external shape.

CAPUT LXIX.

Bilacus taurinus, p. 199, t. 82?

It seems strange that Rumphius should say, “flores ignoti mihi hactenus sunt,” and that, notwithstanding this, they should be fully represented in the 82d plate, which in the explanation is called *Bilacus taurinus*. I am therefore inclined to think, that the plate may represent the following plant, the more especially as it has no thorns. In this case, the fruit A, table 81, as stated in the explanation of that figure, may, in fact, represent the *Bilacus taurinus*, which, on this supposition, would be a mere variety of the *Ægle marmelos*, and the most common form indeed, which this tree assumes in the Gangetic provinces; and, according to Rheede, it is the *Slymappel* of the Dutch, which is the *Covalam* of Malabar. It must, however, be confessed, that the interior structure of the fruit, as I have described it, agrees entirely with that of the *Bilacus tellor*, as given by Rumphius; but not at all with that of the *Bilacus taurinus*, which has only four or five seeds in each fruit, in which circumstance, also, it by no means agrees with table 82.

Bilacus Amboinensis silvestris, p. 200, t. 82?

For the reasons mentioned in the Commentary preceding, I suspect that this is the plant represented in table 82,

although the contrary is stated in the explanation of that plate. It seems, at any rate, to represent an *Ægle* different from the *marmelos*, and hitherto unnoticed in modern systems.

P. S. In enumerating the synonyma of the *Eugenia Jambolana*, it escaped my notice, that it is the *Caryophyllus aromaticus* β of Burman (Fl. Ind. 122).

Since writing the Commentary on the *Lansium domesticum*, Mr Jack has published an account of this tree (Lin. Trans. xiv. 115), to which I beg here to refer; only observing, that he classes it with the *Meliæ*, an order which requires much revision, as it depends on the flower alone.

XXI.—*On the Power possessed by the Spider of propelling its Threads, and on the Ascent of that Insect into the Atmosphere.*

By JOHN MURRAY, F. S. A. F. L. S. F. H. S. &c. &c.

(*Read 20th March 1824.*)

IF the business of the entomologist be confined to the collection of a portfolio of butterflies, or the technicalities of mere nomenclature, we may consent to the praise of diligence and labour, but cannot approve the soundness of his views as a naturalist. Confined within these unenviable limits, entomology is but dull and unprofitable.

I do hold, however, that the entomologist may reasonably assume higher vantage ground, and lay claim to nobler pursuits; and if the physiology of insects be taken into the estimate,—their curious structure and mechanism,—their habits,—their amusements,—their cares and sorrows, the study expands in interest and importance. In this last pleasing department, Messrs Kirby and Spence have high claims on our grateful respect.

After we have bewildered ourselves in computing the movements and revolutions of those wondrous orbs that

float in fearful sublimity in the boundless sky,—marvelled at their mighty structures, and wandered wearily from planet to sun, and from star to star, till we have been lost in the exceeding majesty of the scene, it is refreshing to the exhausted spirit to descend from the celestial excursion, and join the ranks of the botanist, or the entomologist, and to feel assured that the goodness of the DEITY has not been exhausted on those unmeasured worlds, but that his beneficence is extended to the lowest of his creatures.

Among the various phænomena presented to the research of the entomologist, there does not seem one more curious and interesting than the ascent of the wingless Spider into the atmosphere,—a fact unquestionable and unquestioned. It is one, however, recorded without a solitary attempt toward its solution. I have consulted authorities in vain, among others, Linnæus, Shaw, and Donovan.

The gossamer-web was formerly believed to be a tissue of “scorched dew;” hence Spenser—

The fine-net which oft we woven see
Of scorched dew.

Even Dr Hooke said that the gossamer only “much resembled a cobweb,” and believed that “the great white clouds that appear all the summer time might be of the same substance.”

Swammerdam and De Geer ridiculed the idea of the flight of spiders.

Dr Hulse first observed the property which particular spiders possess, of propelling their threads into the air.

Dr Martin Lister discovered that spiders were wafted aloft on this airy vehicle; and in fine weather (in September) he found, more than once, a spider which, from its flight, he called “The Bird.” Afterwards, he noticed that the insect, by elevating the anus, darted a thread from thence, and thus rose into the atmosphere.

From the highest point of the Cathedral of York, Dr Lister beheld the gossamer-webs floating far above him.

Mr White of Selborne confirms, by actual observation, Dr Lister's account. He noticed a spider dart off from the page he was then perusing, and, though the atmosphere was tranquil, it rapidly ascended.

It has been considered that this property is not peculiar to one species, but that several spiders, when young, can so elevate themselves.

Mr White conceived that spiders in their transit through the atmosphere could coil up their threads, and descend *ad libitum* from their aërial excursions, altering in this manner their specific gravity.

I am not aware that any have attempted to describe the gossamer-spider as a distinct and peculiar species, Bechstein and Starck excepted; but they seem to describe different species.

Thus the former describes it as being the size of a small pin's head, having eight eyes disposed in a circle; body of a dark-brown colour, and light-yellow legs.

Starck describes his one as extending more than two lines in length, eyes in the form of a square, two on each side, in contact with each other; thorax of a deep-brown colour, with paler streaks; the under side of the abdomen of a dull white, and a dark copper-brown colour above, having a dentated white spot running longitudinally down the middle.

Dr Starck imprisoned several of these under a bell-glass, on a grass-plate, and he tells us they existed two months without food, though they took water greedily.

Mr White observed a remarkable phænomenon on 21st September 1741. Early in the morning the whole country was enveloped in a coat of cobweb, wet with dew. His dogs (being on a shooting excursion) were blinded by them.

A delightful day succeeded. About 9 o'clock A. M. fell a shower of these webs, (not single threads, but formed of flakes), some nearly an inch broad, and 5 or 6 inches long; and such flakes continued to fall during the entire day. Baskets-full might be collected from the hedges; and from the velocity of their fall, it was evident that they were considerably heavier than the medium through which they descended.

The small spider with which these remarks are connected, has its eyes disposed in a *circle* somewhat elongated,  the body and legs, examined with a lens, are hairy, palpi bifid, and protuberant at the end; tarsus forked or clawed; legs, &c. somewhat translucent; abdomen and thorax glossy, and of a dark ferruginous colour; anal processes 3; the femur and tibia have each two articulations.

Several of these spiders, included in a crow-quill, were transmitted to Professor Jameson. Those called "Money Spiders" by the reapers in some parts of England, I presume to be the same insect.

The Reverend Mr Kirby writes me, that he thinks the *Aranea obstetrica* of Starck is that now spoken of: but the one described by Starck under this name is *striped*, and the eyes are arranged in the form of a *square*, which are sufficient distinctions. The subject of this communication approximates more nearly to Bechstein's *A. obstetrica*.

I shall take leave to call it "*Aranea aëronautica*," because, under the name *Aranea obstetrica* the German naturalists describe *two different insects*; and I, moreover, believe Starck's *A. obstetrica* to be (perhaps) the *young* of the *Aranea geometrica*, met with in hedges. The chief reason, however, for my proposing the assigned name, is the fact I have discovered, that its ascent and movement in the atmosphere are *essential to its very existence*.

I know well that the *Aranea geometrica* does possess the power of propelling threads into the atmosphere, and of thus changing its locality or making its escape; and perhaps, too, the *young* of this insect may possess the power of taking an aërial excursion occasionally. Now, *if so*, I am persuaded it is a *very rare* event. The other is distinct and peculiar, and the numbers that occur in the atmosphere are such as sufficiently to account for the *gossamer*, and its beautiful and interesting phænomena. It cannot therefore be doubted, that those threads which glisten in the sun-beam, and float in the air from the hedges and hedge-rows, and the reticular tissue on grass, which, when sparkling with dew, refracts so beautifully the tints of the rainbow, are the work of the aëronautic spider.

As a proof that these wingless "birds" are more numerous than may be generally suspected, I may merely mention, that, in the month of July 1822, on the top of the coach from Kidderminster to Stourbridge (a distance of only nine miles), there fell on me, or near me, *thirteen* aëronautic spiders, all of which I caught, and imprisoned in chip-boxes, which I carried with me for that purpose. This species of spider may be frequently met with in *coach-offices*, having alighted on the passengers, or on their luggage.

Connected with this question, I may mention a curious phænomenon that I witnessed on the 16th September last year, at Bewdley, Worcestershire. Between the hours of 11 A. M. and 2 P. M. the whole atmosphere seemed to be a *tissue of cobwebs*; they continued to fall in great numbers, and in quick succession. The temperature was 72° Fahrenheit. Some of these were single, others branched filaments, occasionally seen to extend from 40 to 50 feet in length. Others were woolly films, or flocculi. Some fell slowly, and others more rapidly. This was first noticed in the market-place, at Bewdley; and, on repairing to the adjoining fields,

I found the same phænomenon, and my clothes were most curiously invested with a net-work of spiders' threads.

In a communication to the Reverend J. J. Freeman of Kidderminster, I remarked this circumstance; and the following is an extract from his letter to me, dated 18th September 1822:—"The fall of cobwebs was also observed here on Monday. A gentleman told me he was obliged to wipe his face several times while walking in his garden about 12 or 1 o'clock, such quantities continued to fall on him."

On the 19th of July 1822 (the anniversary of the Royal Coronation), the yeomanry, at 1 o'clock P. M. were drawn up in the market-place at Kidderminster, and fired a *feu-de-joie* on the occasion. This had the effect of bringing great numbers of the *Aranea aëronautica* from the aërial regions; very many I picked up from the pavement, when the yeomanry had withdrawn; and several took refuge on the table where I was engaged reading, near the window of the hotel, and which was then partly open.

I have stated that a free and unrestrained privilege of ascent into the atmosphere is a condition essential to the very being of these remarkable insects.

The Blaps *mortisaga*, it is known, will live *three years* shut up, and without food. I have kept the *Aranea diadema* two months under similar circumstances. An entomologist informed me he had kept a spider three months without food; and indeed this insect has been preserved alive *upwards of a year* confined, and wanting nutriment.

The *Aranea aëronautica*, however, I have invariably found, is impatient of confinement, and will *die*, whether imprisoned in a chip-box or glass-tube (shewing that *light* does not affect the question), sometimes in *twenty hours*, or at most in *two or three days*.

I introduced one of the aëronautic spiders under water;

but though it remained there upwards of a minute, it did not appear injured thereby; and when withdrawn, soon let itself fall from a point, by means of a thread.

Posited gently on water, at 66° Fahrenheit, it remained on its surface, without attempting to escape by the propulsion of a thread. It took repeated springs forward, and then receded, patting the water rapidly with its tarsus, in the manner of the squirrel.

In water at 67° Fahrenheit, it was quiescent. When reposing at the bottom of a tumbler of water, there issued from between the palpi an air-bell, which, expanding, carried the spider to the surface; the aërial appendage thus diminishing the specific gravity of the aggregate, and affording a striking elucidation of the habits of the *Aranea aquatica*.

An aëronautic spider being put into water at 94° Fahrenheit, remained at the bottom of the vessel, sometimes at rest, sometimes locomotive. It projected a thread upward, and by that means, *sailor-like*, wound itself, resting at intervals, to the surface of the water. At the close of the experiment the temperature of the fluid had fallen to 86° F.

One of these spiders, by candle-light, darted instantaneously a thread to the ceiling of the room (eight feet high); it described an angle of about 80° with the horizon. By means of the combined act of the tibia and tarsus, "guiding them wittingly," the thread was made to spin with great rapidity on its axis; and during this period it moved gradually toward the vertical plane, and, being thus highly twisted, formed a stronger medium of escape.

During my stay at Chester, while I was experimenting with an aëronautic spider, during a warm day, and brilliant sunshine, about noon; when my room-door was a-jar, and the insect in the act of propelling its threads in all directions, it suddenly darted toward the door, in the direction

of the influx-current, a thread perfectly horizontal, and in length 10 feet. The angle of vision being particularly favourable, I observed an extraordinary aura or atmosphere round the thread, and which I cannot doubt was electric.

There are many phænomena that dispose us to believe the thread to be electrified. The following diagram will afford a representation of one of my experiments made in a room. The deflection from the vertical plane in the direction of the dotted diagonal line, is, I think, to be ascribed to the attraction obtaining between the wall as the conductor and the electrified thread. The aëronautic spider threw out two threads toward the ceiling, one perpendicular, and the other inclined; and then let itself fall from the end of a quill, resting at a woolly ball, and from thence projecting a horizontal thread, subsequently descending.

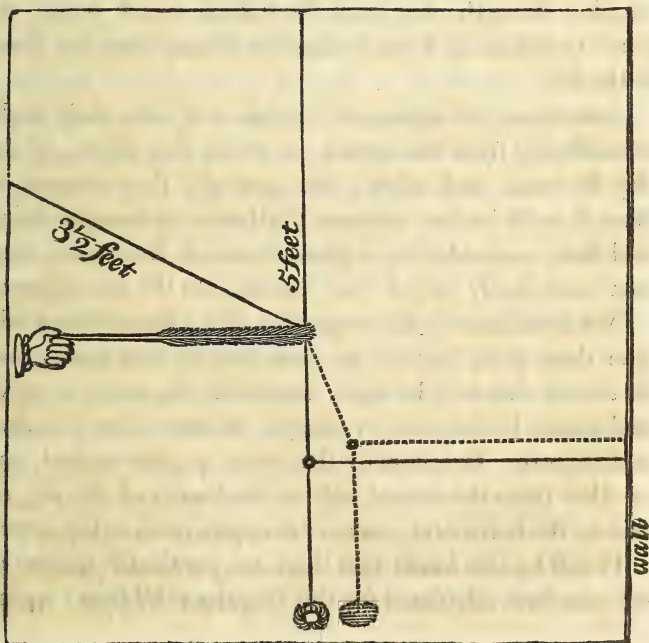

I first began my experiments and observations on this curious subject on the 2d of June 1822. One of these spiders alighted on me, and glanced off from my hand with considerable rapidity : thermometer 77° in the shade.

It is impossible to walk in the fields without being saluted by several of these insects ; they will be chiefly noticed by alighting on the hat, and descending by a thread before the face : in this way they are easily caught, as they will drop into a chip-box, and may be secured. Received on a pencil, or the like, they will soon be perceived to oscillate like the pendulum ; oftentimes rising from the perpendicular into the horizontal plane, at each ascent projecting a thread into the atmosphere ; and, finally, by a twitch or jerk, the insect breaks from its anchorage, and ascends. It is difficult to determine whether the insect *bites off* the connecting thread, or breaks it off by main physical strength ; but from the sudden twitch which appears to detach it, I am inclined to believe that the latter is the fact.

Sometimes the aëronautic spiders will take their flight immediately from the surface on which they alight, if the day be warm and sultry ; but generally they descend to from 6 to 18 inches, perhaps the better to *insulate* them, and that, suspended by a pliant thread in free space, they may more freely propel their threads into the atmosphere.

Not unfrequently the propulsion of a solitary thread will bear them aloft, but the air must then be very warm, and its electric character be high. Sometimes the ascent is rapid, and cannot be followed by the eye ; at other times it is slow and majestic. Occasionally the ascent is quite vertical, and at other times the animal sails on the bosom of the air, either in the horizontal plane, or at angles more or less acute.

It will be also found that there are *particular seasons* of the year best calculated for this singular exhibition : spring

and autumn are those periods. In summer I have frequently found it utterly impracticable to determine their ascent. When they detached themselves, after several vibrations, they have fallen to the ground like a dead weight. One day last summer (May) this remarkable fact was determined in the case of nearly a dozen which I picked up,—all that I experimented with on that day.

The insect would seem to be aware when the threads are sufficient for its ascent: perhaps the temporary suspension in the horizontal plane may communicate that information.

The aëronautic spiders make their appearance early in the season. One fell on me in the beginning of March last (1823), while I was perambulating the streets of Bath.

I have frequently shewn the phænomena of the aëronautic spider to my friends, and to Mr T. Hopkins of Kidderminster, and Mr T. Brown of Cirencester. To the latter, indeed, I one morning, in a very short period, pointed out the phænomena in five or six different instances.

Several circumstances concur to shew the phænomenon of ascent to be *electric*. The propelled threads *do not* interfere with each other; they are divellent, and this divergence seemed to proceed from their being imbued with similar electricity; and the *character* of that electricity appeared to me to be an interesting subject for subsequent research.

The aëronautic spider, brought near a candle, descends by its vertical thread, winds it up, and descends again very rapidly and repeatedly. The flame seemed not to attract a short upright thread, though the *finger* brought near, did. Placed nearer to the flame, the animal seemed incapable of descending farther, but moved circularly.

The point of a gold wire was brought near to the vertical thread, in one experiment, and above the spider in the act of escape to the ceiling of the room. It evidently dis-

concerted its progress, and the animal seemed agitated and unable to ascend. On removing the point the insect soon made its escape.

When the conducting wire is brought near to the thread by which it suspends itself, but, above all, to the flocculi or wool-balls, the thread is considerably deflected from the perpendicular, and the horizontal fibre is attracted by the point.

When a metallic conductor is brought near to the suspended spider, it disarranges its projectiles, and the insect, conscious of some counteracting agency, promptly coils up its threads.

When a stick of excited sealing-wax is brought near the thread of suspension, it is evidently *repelled*; consequently the electricity of the thread is of a *negative* character. The descent of the thread is instantly determined by bringing over it the excited sealing-wax; and if strongly excited, and the spider let fall on its surface, it bounds from it with considerable energy.

On the 3d of July 1822, at 4 P. M., thermometer 66° Fahrenheit, two aëronautic spiders, on separate threads, were brought near to each other; a mutual repulsion supervened; and when one was brought in momentary contact with the other, it immediately fell lower in the perpendicular plane.

An excited *glass-tube* brought near, seemed to *attract* the thread, and with it the aëronautic spider. When the insect was thus *positively* electrified, the rapidity which marked its descent, and extent of thread spun out, and which I frequently coiled up, was truly astonishing, being at least 30 feet in length.

In one experiment made, the ascent of the insect was so slow and tranquil, from the humidity of the lower atmosphere and wetness of the terrestrial surface, that I could

easily catch the insect by following its progress: it moved in a plane parallel to the point of departure.

On the 4th August 1822, at 3 P. M., thermometer 66°, the ascent was slow and beautiful, the little aëronaut rising regularly in the vertical plane. It was distinctly perceived from the steady fixation of the eye, and favourable angle of vision, until it had attained an elevation of 30 feet at least, and was finally lost in the vanishing point of elevation.

A variety of other phænomena unite their testimony in favour of the conclusions which I have formed, and from what I consider the direct method of induction.

Were the thread not electrical, I do not see how it should be propelled through the atmosphere in the vertical plane, and remain there, contrary to the laws of gravitation. It is indeed remarkable, that the threads should remain in the precise plane in which they are propelled, nor ever swerve from that path. The constant relative separation finds an analogy in similarly electrified pith-balls, or the divergence of the filaments in the case of a glass plume, &c., placed on the conductor of an excited electrical machine. The undulations of an agitated atmosphere disturb rather than favour the ascent of the little aëronaut. The electric or calorific state of the atmosphere will be found always to modify the phænomena. The transit of the thread through a resisting medium, without its suffering deflection in its path, proves it to be imbued with a power superior to, and able to combat with or overcome, that resistance*. The instantaneousness of the propulsion of the projectile

* The friction sustained in its sudden propulsion through the resisting atmosphere would alone be capable of investing it with electricity. I have seen, in the case of a fibre of very fine-spun glass suddenly drawn upward, that it continued *vertical*, and I found it *electrical*.

can find no reasonable cause but in the subtilty of electricity and excitation of that mighty power. An illustration somewhat connected with the question is found in the propulsion of fine threads from melted wax connected with the conductor of the electrical machine in action, the threads being received on the surface of paper.

When the superior regions of the atmosphere are charged with *positive* electricity, while the threads are imbued with *negative* electricity, ascent into the atmosphere becomes a *necessary consequence*.

It is difficult to ascertain what part this ascent into the atmosphere subserves in the economy of Nature. Whether the spider becomes food for other insects, remains a question; but I have, in *several instances*, found that, while it oscillated, some prowling *Vespa*, or wandering *Musca*, has snapt up and carried off my “*Aranea aëronautica*.”

MACCLESFIELD, }
October 31. 1823. }

XXII.—*Observations on the Migrations, or occasional Migrations, of the Golden-crested Regulus, or Wren.*

By P. J. SELBY, Esq. of Twizell-House, Belford,
M. W. S. &c.

(*Read 20th March 1824.*)

IN the course of my ornithological observations, I had for some years remarked, that the Golden-crested Regulus, or Wren, (*Sylvia Regulus* of Latham and Temminck), at a particular period of the year, suddenly became more numerous and abundant than I could account for, from the quantity annually produced in my immediate neighbourhood. The time I allude to has usually been towards the close of October, or beginning of November. At first, I thought the influx might come from the northern parts of Scotland, and probably consisted of the young of the year, which at that season were impelled to seek a warmer winter residence: I found, however, on extending my observations, that the same fact occurred along a great extent of the eastern coast of Scotland, and that their arrival there was simultaneous with those in Northumberland and the coasts of the adjoining counties. I was also aware that it had always been esteemed indigenous in Scotland and its islands, and a permanent resident of its native localities. I therefore abandoned this supposition, and felt convinced that the strangers came from countries still more distant, and in which they were a regular migratory species. This con-

jecture received strong and satisfactory confirmation in the autumn of 1822, when I had the satisfaction of witnessing their arrival upon the coast, fatigued and spent by their distant and, for so diminutive and to appearance delicate a bird, almost incredible flight. This happened after a severe gale, which commenced on the 24th of October 1822, at N.E., and continued during the whole of the 25th; but which, for some hours previous to its conclusion, veered about to the E. and S. of E. On the morning of the 26th they were seen to arrive by hundreds upon the beach, so fatigued and overcome by the unfavourable change of wind, the length of their journey, or both combined, as to drop the moment they reached land, unable to make any further exertions. Great numbers were in consequence at first taken by the hand, unable to rise or escape their pursuers. Some idea may be formed of the incredible numbers which came over in this flight, furnished in all probability by the forests of the northern parts of Europe, when I mention that I have traced it to have extended from beyond Berwick northwards, along the whole line of coast as far as Whitby in Yorkshire; but how much farther to the north or south of these points I have not yet ascertained.

With the same gale we received a great importation of Redwings and Fieldfares, and a very abundant flight of Woodcocks, all known as emigrants from the northern parts of Europe; but none of these appeared to have suffered from fatigue to the same extent as their diminutive companions. As soon as they were a little recovered from the effects of their distant flight, they spread themselves over the country adjoining the coast, and at first filled every hedge and plantation; but they appeared still desirous to move southwards, and their numbers rapidly and daily decreased; and I remarked that, about Christmas, scarcely more than the annual average quantity remained.

Hitherto I had always considered, and indeed had found, the *Regulus* to be a permanent resident, even during the severest winters; but what took place last season, proves, that even those species which under usual circumstances, constantly inhabit their native localities, are compelled, by unusual and peculiar contingencies, to vary their habits, and become subject to those laws which direct the migratory movements of the feathered race. As I before mentioned, about Christmas their numbers appeared reduced to the usual standard, and they remained subject to observation till after the first severe snow-storm, which we experienced in the beginning of January 1823. They appear, however, to have had some presentiment of what was about to follow, as they left the country to a bird, during the short interval of thaw which took place previous to the commencement of the second storm, so severely felt throughout the northern parts of England, and a great part of Scotland. Expecting their return in spring, at the usual time they begin to breed, I looked for their reappearance with considerable interest; not a single pair, however, could I discover in all their accustomed haunts, long after the usual time of nidification, and when our plantations are wont to be alive with the stridulous song of the male; nor was a single *Regulus* visible in any part of Northumberland till October last, when a few arrived at the time I have before stated the strangers annually make their appearance, some of which I perceive still remain with us.

During an excursion in Scotland, in August and September 1823, I did not neglect to look for them in every likely locality, and in places where I had previously seen them very plentiful, but without success. Titmice I found abundant, particularly the *Parus ater* (Cole-mouse), which inhabits all the fir-forests and plantations; but I could not

discover the *P. cristatus* (Crested Titmouse), said to inhabit the Forest of Glenmore. This unexpected and unwonted desertion in all probability proceeded from some instinctive feeling, which impelled them to fly from approaching danger; but what causes prevented their return to their native habitats after the severity of the season was past, is a question not so easily solved. Among various surmises, it has occurred to me, that the late period of the season, or rather early part of the year, at which this migration took place, as well as the distance to which it extended, may have combined to prevent their return to their native haunts in sufficient numbers, or at the usual period they begin to breed; and that thus situated, they have been obliged to yield to the imperative demands of nature in those parts, or on their return from those regions to which they had been driven under such unwonted circumstances. What favours this supposition is, the very early period at which the *Regulus* begins to feel the influence of love, and to breed, for they very frequently pair towards the end of February. Their migration did not take place till the last week in January, which allows but a short interval to elapse before the amorous propensities would be in action, and these probably accelerated by the mildness of the climate in which they had taken refuge. I have not yet ascertained whether the *Reguli* of the southern parts of England were likewise observed to migrate, or if they were known to breed in their usual or in greater numbers during the last season, viz. that immediately following their migration from the north. Few, I am afraid, will be found to have paid the attention necessary to establish these facts, particularly as the object is of so diminutive a complexion, and offers but little to excite attention or remark, except to those ardently engaged in ornithological pursuits.

January 20. 1823.

XXIII.—*General Observations on Geology and Geognosy, and the Nature of these respective Studies.*

By the Rev. JAMES GRIERSON, M. D.

(Read 7th February 1824.)

SOME have thought that, in studying the sciences, the ancient Greeks had a considerable advantage over us moderns, on account of the peculiar terms by which scientific ideas are expressed, being mostly taken from their own language instead of a foreign one, and consequently more familiar to them. Thus the words Geology, Geognosy, Geography, Astronomy, Astrology, for example, are all we may say Greek, and would be as easily understood by a Greek novice when entering on the study of any one of those sciences, as Discourse of the Earth, Knowledge of the Earth, Delineation of the Earth, Laws of the Stars, Speech of the Stars, would be by an Englishman when he is entering on the same study. Now, whatever be in this (and we do apprehend there is not much in it), no doubt can be entertained, that the multiplication of terms unnecessarily,

and the inaccurate or vague use of them, are among the greatest obstacles to the advancement of true science. This remark has been thought to be peculiarly applicable to the science in which we are more immediately interested, and which it is the object of the Wernerian Society more particularly to advance. The introduction of many new terms has been objected to, as tending only to overload and perplex the nomenclature. I am far from allowing that the objection is in general well-founded, though there may, perhaps, be found a few instances in which it is; but my object at present is to shew, that the word Geognosy, as introduced by WERNER into the department of Mineralogy (and which has been much exclaimed against as unnecessary and superfluous), is by no means so. We all know, that, previously to him, there had been numerous attempts made to account for the present arrangement and state of the materials of which the globe of the earth is composed, or to show what particular agent or agents had operated, in the way of natural causes, to bring into their present form and situation the substances of the mineral kingdom. These attempts, which have been called Theories of the Earth, had, before the age of WERNER, proceeded upon by far too limited a knowledge of minerals, and had taken for granted a thousand things which the authors of the respective theories could by no means prove. They were, in fact, little more than fancies,—a sort of philosophical romances, which might amuse the imagination, but conveyed no real knowledge.

As was not unlikely to happen, the first theorists turned their attention more particularly to a great and remarkable event recorded in history (in the oldest history by far now extant), and of which we have also traditional accounts, more or less distinct, in almost every part of the world. They supposed the Earth to have been created in a certain

state (some of them in one, some in another), and then they set themselves to account for the changes which, in their opinion, a deluge of water would produce upon it.

Burnet, for example, in 1681, supposed the Earth to have been an immense abyss of water, covered by a smooth crust, which, being broken and deranged at the Deluge, produced, by its fragments, mountains, islands, and all the great irregularities we now perceive on the globe. Woodward, in 1702, fancied that, at the Flood, a suspension for a short time of the attraction of cohesion took place among the particles of all mineral substances, and that the globe, being thus, as it were, dissolved and converted into a soft paste, shells sunk into it, and so are now found in the heart of solid rocks, and at a great depth below ground. Whiston, in 1708, imagined that the Earth was formed from the atmosphere of a comet, and that the Deluge was produced by the tail of another! Others, paying less attention, or we may say no attention at all, to the accounts we have in Scripture, said the world was an extinguished sun, or a vitrified globe, on which, as it cooled, the vapours gradually condensed, forming seas and lakes, which afterwards deposited calcareous matter. Such were the fancies of Leibnitz and Descartes in 1683 and 1749. But a still more extraordinary fancy (*Quid tam absurdum quod non dictum fuerit ab aliquo Geologo?*) was that of Demaillet, who imagined the Earth to have been entirely covered with water for some thousands of years, and that men were then a sort of fishes, and lived in that element. Buffon's imagination seems to have been guided in its flight very much by that of Leibnitz. Both held the Earth to have been originally a fiery mass, gradually cooled down, and arranged so as to be at last rendered a fit habitation for plants and animals. Only Leibnitz will have it to have been an entire sun, while Buffon tells us it was only a

part of one knocked off by a comet. These are, no doubt, very fine specimens of closet world-building, worthy of being preserved in the cabinets of the curious. Delightful romances! But we have some still better—we have higher flights of the imagination yet on this subject. Later writers have supposed that every thing was originally fluid, and that this fluid was inhabited by an infinitely great number of infinitely small and simple animals and vegetables, which, by their exuviæ, in a course of ages, produced calcareous matter and other substances, forming the solid body of the Earth; so that the mineral kingdom, according to them, is no more than the debris or exuviæ of the animal and vegetable. The original or infinitely small monadic animals and vegetables, Lamarck, and others, who hold the same system, tell us, gradually acquired different habits, became larger and more diverse from one another; and hence all the animals and vegetables we now have. Others, again, such as Kepler and his followers, not content with peopling the globe with an infinite number of small monadic animals, and setting their debris and that of vegetables to form mountains and the other solid parts of it, have told us that the globe itself is one great animal, possessing sensation and volition, digestive and respiratory organs, in short, all the qualities of a living being! Fine examples these, we see, of geological speculation, which, if they do not evince much power of observation, or great accuracy of deduction, certainly shew no deficiency in power of fancy. But, *umbrarum hic locus est*; let us leave these purely imaginative philosophers for others of a more sober cast,—others, who would look upon themselves as degraded,—indeed, as grossly insulted, to be placed among what we may call the pretty *novelistic* geologers. And yet it does appear that some of these, even of these soberer ones, hold opinions little, if at all, less strange than certain of those we have already enume-

rated. Delametherie, for instance, thinks that almost every thing was formed by crystallization. Dolomieu will have it that immense currents, of many hundred fathoms deep, swept at various periods the bottom of the ocean, and from thence throwing up sand and shells and other substances, deposited them upon the continents, to form hills and mountains. M. de Marschall, as late even as 1802, has informed us, that the superficies or outer crust of our globe is made up of a variety of fragments, which at different times fell down from heaven in the way of meteoric stones, and, as a proof of the same, refers us to the *exuvix* of the unknown animals now found in the strata.

In the very same year with this discovery, the scientific world was called upon to believe a truly sublime and beautiful doctrine, namely, That there exists in the central parts of the earth an immense fire, or source of heat, which at certain periods breaks out, and acts with intense and irresistible violence, after having lain dormant for an indefinite number of ages;—that the matter of the different continents and islands over the world being constantly washed down by the rains, and other wasting processes of the atmosphere, into the rivulets and rivers, is by them conveyed to the sea, and ultimately to the deepest parts of it; and that, when this is sufficiently accomplished, and an abundant stock of mud and other things is there deposited (which probably takes place in some millions of millions of years), the great fire begins to burn, and, under the immense pressure of the waters of the ocean, bakes, as we may call it, the stuff, melting or at least softening it;—that then the fire for a time ceases or goes out, permitting the materials to cool, and so form strata;—that when this has happened, and the strata are sufficiently hardened or consolidated, the fire lights itself up anew, and, in a far more furious and irresistible form than before; not waiting, as it did in time past,

to melt or soften the materials on which it acts, but violently heaving them up in a broken and dislocated state, along with fluid granite and trap, through the ocean, thereby causing, of course, its waters to flow off towards the former land;—that this takes place with such inconceivable force and fury as to turn the whole of the former continents with their inhabitants into the bottom of the sea;—a new continent, or continents, and islands, are thus formed out of the elevated bottom of the ocean, and the fishes and apoda turned off from their former quarters, to frisk about on that portion of the earth's surface which formerly belonged to the terrestrial animals, the fate of which may be easily conjectured:

“ Occupat hic collem ; cymba sedet alter adunco ;
 Nat lupus inter oves : fulvos vehit unda leones,
 Unda vehit tigres : nec vires fulminis apro,
 Crura nec ablato prosunt velocia cervo.”

Such was the creed of the late celebrated Dr HUTTON of this place, as illustrated by the late, no less celebrated, Professor PLAYFAIR,—a gentleman, this last, remarkable for his many and valuable accomplishments, but for none more than for the elegance and felicity with which he always expressed himself when he wrote on subjects of natural science. His master in geology (I mean HUTTON) had sublime and extensive views, but he could not clearly exhibit them to the minds of others. No man ever stood more in need of an illustrator, and no man ever found a more admirable one than he did in the person of his pupil. But what proof have we that a central fire exists? And what proof have we that the materials carried down by the rivulets and rivers are ultimately deposited in the bottom of the ocean? I can perceive none,—not even of this latter position. Everywhere do we see holms, and carses, and bars, and deltas, thus formed at the mouths of rivers, but

no evidence can I perceive that the materials go farther. The first principles, therefore, of this theory are, like those of the others at which we have been looking, in my opinion, purely gratuitous.

WERNER, as I have already hinted, and as is well known and acknowledged, was the first to introduce into this subject what may be called the truly inductive method. He taught us, that, before drawing conclusions, we should look at the objects before us, and should make ourselves acquainted with their distinguishing properties, before we attempt to explain their formation: in short, that we should become mineralogists before becoming geologists, or know of what the earth is made, before we pretend to tell how it was made. On these principles of true and legitimate mineralogical philosophy, so happily introduced by him, and now so generally acted upon by his numerous, I had almost said innumerable, pupils throughout the world, the science is making such unprecedented and rapid advances, as that it may be expected soon to comprehend a pretty complete knowledge of the unorganised kingdom, at least as far as this ever can come under our observation. Nowhere, however, I think I may, without an approach to flattery, say, have the Wernerian, or truly scientific methods of investigation in this department of nature, been followed with more ability, and attended with greater success, than in our own country; and when I say so, no one can fail to perceive that I allude to our President. But though WERNER and he, and the immediate successor of WERNER, not to mention any more, have indisputably put us on the right road, and also conducted us a great way along it, surely it would be rash to affirm that every thing has been accounted for, and that the science of mineralogy is already perfect. Certainly no. Many things, after all that has been achieved, still remain unexplained, and there

is abundant room for future discovery. I do not, however, look upon the great merit of the system of Werner and his disciples as arising from the satisfactory manner in which it enables us to explain the *formation* of minerals (though in this respect, also, it certainly appears to me to be greatly superior to every other that has yet been introduced); I consider its merit as arising chiefly from the facility and certainty with which it enables us to distinguish the objects of the mineral kingdom from one another, or to arrange and classify them. This is the principal point. No doubt, it would be satisfactory, aye, inexpressibly gratifying and delightful, to know the particular way in which every object in the mineral, as well as in the other two kingdoms of nature, was formed. “Felix qui potuit rerum cognoscere causas,” is a principle deeply seated in the human breast, and of which we all very powerfully feel the influence. But I am afraid the desire of gratifying it not unfrequently leads us astray. What but this desire, operating in an excessive manner, led to all the fanciful theories and singularly extravagant positions, which I have already taken notice of, with a great many more of the same sort, too tedious to mention?

Mineralogy and Geognosy have, I think, abundant interest in their investigations, independent of the manner in which the objects about which they are conversant were formed. To know and distinguish these, to arrange or classify them; ascertain their properties and relations, so as that when we find one, we may in some degree know where to look for another; to ascertain their uses; to find whether there is any order in the structure of the earth on the great scale, and if so, what it is;—these, I should think, are subjects sufficiently attractive and interesting to any philosophic mind, and this is perhaps all the length we shall ever be able with certainty to go in the path of the

science of which I now speak. For the subjects about which we reason are so hid from our view, and so completely beyond the reach of any thing like a thorough investigation, that it is nearly as unlikely we shall ever fully ascertain the manner of their formation, as it is unlikely we shall ascertain whether there are inhabitants in the moon or no. The subject, however, certainly has abundant interest without this, without any speculations and conjectures about the modes of original formation;—as much interest, I believe, as Botany has, or Zoology, or even Astronomy itself. Now, what botanist, or what zoologist, when he finds a new plant, or a new animal, puzzles himself and his readers, by endeavouring to ascertain how it was formed, or how it came to be in the place in which he found it? It is sufficient for him to know what place in his system the plant or the animal is to be referred to, what are its distinguishing properties, what are its uses, economical, medical, or ornamental. So in Mineralogy. It is sufficient, I conceive, to ascertain the distinguishing properties and uses of a simple or compound mineral, of a rock or a mountain, a stratum or a vein. Why speculate, and fancy, and suppose, and take for granted, and bring our science into contempt, by what are called Theories of the Earth? WERNER, in the comprehensiveness of his mind, seems to have felt this impropriety, and, in order to avoid it, introduced the term Geognosy, by which he meant to distinguish the legitimate and useful department of the science of Mineralogy, or rather of Geology, from the purely fanciful and useless part of it, which consists in pretending to explain how the Earth was at first formed, and how the successive changes it may have, as a whole, from time to time, undergone, took place. Geology he leaves to express this, which it had been too often understood to do (though Geogony is the more appropriate term); and

Geognosy is understood by him to indicate the distinguishing, grouping, or classifying, on the great scale, the various substances which constitute the exterior parts or crust of the globe, that is, all that portion of it of which we ever can come to the certain knowledge. For that we should pretend to speak of what is at the centre, or in the interior of the Earth, is nearly as absurd, I think, as it would be (according to the shrewd observation of a worthy gentleman, now no more) to pretend to tell what is in the inside of an orange by slightly scratching the rind. The deepest mines have certainly not penetrated to any thing like a mile into the Earth, and though they had reached thus far, it would be only about the four thousandth part of the distance from the surface to the centre. But I believe the deepest mines have not gone down more than a quarter of a mile, or about the sixteen-thousandth part of the earth's semidiameter. Therefore we can no more know by all our investigations what is at the centre of the earth, than we could know what is at Glasgow or Perth (if we had never been at either of those places, or had any information concerning them), by moving four or five yards from the place in which we now are. I certainly think it of much consequence that the object of mineralogical study should be rightly understood; for I have met with not a few who seemed to undervalue or avoid it, merely because they had formed a wrong notion of the subject; and, instead of considering this science as the means of becoming acquainted with the qualities, relations, and uses of the substances of the mineral kingdom, looked upon it as nothing more than a tissue of vain and unprofitable conjectures about the original formation of the world.

XXIV.—*On the Mode of Growth, Reproduction,
and Structure of the Poison-Fangs in Ser-
pents.*

By Dr KNOX, F. R. S. E.

Conservator of the Museum of the Royal College of Surgeons,
Edinburgh.

(*Read 24th January 1824.*)

AT an early period of my researches into comparative anatomy, I was led to examine with considerable care the anatomy of a class of animals, dangerous and terrible in their nature, and against which man has declared perpetual war. Dwelling for a long time in a country abounding with these reptiles, and where, during a great portion of the year, by infesting our gardens, houses, and fields, they formed a subject of daily conversation, I was naturally led to inquire into their structure, and even, so far as was practicable, to pay attention to their natural history; but my researches were chiefly of a practical nature, and directed more towards detecting the presence of those organs which have procured for their possessors the hatred of every living animal. Minute and careful dissections, performed lately, have shewn me, that a few facts, in the anatomy and physiology of the poisonous teeth of serpents, had escaped

my notice; and viewing the subject as one of general interest, I have ventured to call the attention of the Society to the following brief history of these organs.

All anatomists are aware that the serpents called poisonous possess two kinds of teeth; viz. numerous simple teeth, implanted in rows into the lower maxillary bone, and into the palate-bones of the upper jaw,—and, in certain species, to be described afterwards, into the upper maxillary bone itself; these are employed by the animal in laying hold of its prey. These teeth have, I believe, generally been considered permanent; but this opinion I do not consider correct, because they are found to vary in number even in the same varieties, and because I have observed *unattached* simple teeth in the rattle-snake,—that is, simple teeth of rather a soft texture, placed obliquely betwixt the fixed teeth, and attached to the maxillary or palate bones by soft parts only.

In several innoxious snakes now lying before me, there exist two distinct rows of simple teeth, attached only by soft parts to the maxillary and palate bones, running parallel with those already fixed into the bone. These supplementary rows of teeth are placed internally with regard to the fixed ones in the maxillary bones, but externally to the same in the palate-bones. They seem to me in a perpetual state of growth, and advance to supply the place of those which the animal casts by a regular process of nature, analogous, no doubt, to the mode of dentition so long ago observed in certain fishes, as the shark, &c. Moreover, the lower maxillary and palate bones, around the bases of the tooth, have the same loose, cellular and vascular appearance as that portion of bone to which the fangs are attached, and which will be described more particularly in a future part of the paper. A section of the jaw-bone demonstrates, that, when once the tooth has become fixed, its mode of

nutrition alters, as it now receives its nourishing vessels from the centre of the bone itself, through which may be traced a canal filled with soft parts, and communicating by a large orifice with each of the fixed teeth. The periods at which the animal casts or sheds these teeth are unknown to me, but one would naturally conjecture that it may be annual: the subject is open to the inquiries of the naturalist.

It has been already observed, that the simple teeth, even in poisonous serpents, are not confined to the lower maxillary bone and to the palate-bones in the upper jaw, but are found in certain serpents, implanted also into the superior maxillary bone. Mr Schreider first noticed them in the Hydrus or Water-Snake; and they have also been found in the *Boa fasciata*, *Boa lineata*, &c.; likewise in the serpents called *Trimeresures* by the Count Lacepede. These have with propriety been separated from the other venomous serpents, or those which have only poison-fangs in the upper maxillary bone, and which have been arranged by naturalists under the classes *Crotalus* and *Vipera*. The essential character of this class is, their having only poisonous fangs in the superior maxillary bone, and, consequently, in having the simple teeth confined to the palate-bones in the upper jaw, and in the lower to the inferior maxillary bone. I have found this character unequivocal and constant in all the poisonous serpents I examined in Africa; in the Rattle-Snake, in the common Viper of this country: but I was surprised to find that several varieties of snakes, described by Mr Russel as varieties of the celebrated *Naja*, or Spectacle-Snake of India, have simple teeth implanted in the superior maxillary bone. I first observed this fact in a specimen of a snake given me as a Cobra, and which belonged to an Indian collection sent to the Museum. On observing that there existed a simple tooth in each of the

upper maxillary bones, in addition to the regular poison-fang, I was inclined to think, that, in consequence of the specimen having been somewhat mutilated, its real character might have been mistaken, and that it probably belonged to the *Trimeresures* of Lacepede. On appealing, however, to the specimens in the Museum, I found that the Indian snakes called Cobras, and which agree very accurately with the descriptions given by Mr Russel of certain varieties of the *Coluber Naja*, or Spectacle-Snake, uniformly possess simple teeth, growing on the upper maxillary bone; and hence these serpents can no longer be arranged with the vipers, but ought either to form a distinct genus, or be classed with the pseudo *Boas*, or *Trimeresures**. In a real *Pseudo Boa* †, now in the Museum, I find three simple teeth in the upper maxillary bone. In a common variety of the *Coluber Naja*, there is only one fixed simple tooth belonging to the same bone. In the *Hydrus* (which I have not yet examined) there are several. All these species are East Indian, or at least belonging either to the continent itself, or to the islands scattered over the Indian Ocean. It would be interesting to know, if the circumstance of having both kinds of teeth in the upper maxillary bone be confined to serpents from these countries only ‡.

* The variety examined by me, and of which there exist several specimens in the Museum, is the *Nella Tas Pam* of Russell. I have not yet had an opportunity of examining a specimen of that variety whence the whole family derives its name. It has appeared to me that the Indian snakes generally have the poison-fangs much smaller than the African and American; but this does not seem to have any influence over the terrible poison destined to pass through them.

† Called in Bengal "Bungarum-pamma."

‡ I have placed on the table the crania of three species of snakes, arranged according to their teeth, viz. the cranium of a perfectly harmless snake having simple teeth only; that of a Cobra or Spectacle-snake, and the cranium of a truly poisonous one, said to have come from the East Indies, but which bears the closest resemblance to the common Puff-adder of Africa.

The other kind of tooth with which the poisonous serpent is armed, is the fang, placed in the upper jaw on either side, and firmly fixed into a small moveable bone, generally considered as the superior maxillary. Two muscles moving this bone, and so contributing to give motion to the fangs, pass through the poison-gland, situated immediately below and behind the eye, so that by one and the same action the fangs are driven into the animal or object attacked, and the poison is forced from the central cavity or collection of cells in the gland into the duct by which it is conveyed to the base of the fang, and thence into the canal of the tooth. The structure of the bones, into which the fixed or active fangs are inserted, is very peculiar; nor do I remember to have found its analogy any where, excepting in some fishes. The lower surface of the bone, or that which regards the mouth, and into which the fang is fixed, presents a considerable cavity, divided, as it were, into two portions, into one of which a poisonous fang is fixed,—the other cavity being reserved for the supplementary tooth intended to fill it at some future period. The edges of the bone are unequal; and its base exceedingly vascular, dark-coloured, and, as it were, cellular, and is apparently undergoing a perpetual decay and renovation on its margin. A very remarkable, and so far as I have observed, a constant appearance is, that, on one side of the jaw, the cavity for receiving the supplementary tooth is external, whilst on the other side it is internal; or, which comes to the same thing, the poisonous fang is fixed on one side into the external portion of the upper maxillary bone, whilst on the opposite side it is fixed into the internal portion of the corresponding bone.

I have already remarked, that there is always ample room for two fangs, though most generally there is but one fixed on either side. In a future part of the paper, I have

taken notice of the head of a common viper, in which I found two poison-fangs fixed into either maxillary bone; but such an occurrence must be exceedingly rare, for of the vast number of poisonous snakes I have examined in this and in other countries, the viper alluded to is the only instance in which I have met with it.

Whatever be the situation of the fixed fang, there will always be found a rudimentary one, partly attached to the bone, and preparing to occupy the vacant space described above, and to replace the old tooth, whenever by age or other causes the latter may have been detached from its socket, and separated from the animal. But previous to describing the mode in which we may suppose this process of decay and renovation to be effected, it is essential to explain to the Society the real structure of the fangs themselves.

It is, I think, sufficiently well known, that, in addition to the fixed poisonous teeth, serpents possessing these dangerous organs have others which may be called rudimentary; that is, they have on either side, close to the fixed fang, and suspended to the upper jaw, a certain number of teeth, intended by nature to supply the deficiency in the fixed teeth, whenever these shall have been shed or lost. The rudimentary teeth I speak of, are entirely surrounded by soft parts, each inclosed in a separate sheath, and cannot be seen without dissection. They seem to me to be in a constant state of growth, and indeed present a regular series, from a mere horny point to a tooth, nearly equalling in size, strength, and hardness, the one actually employed, and at the time fixed. We may either consider the tooth as it first appears, tracing it through its various stages to the full-grown tooth, or *vice versa*. The first mode seems the most natural, and it is the one I shall adopt.

At whatever time a poisonous serpent is examined, there

will generally be found a rudimentary fang, so small, that it is nearly of the same form and structure as one of the common palatine or maxillary teeth; that is, it is composed of a horny substance, or enamel, and has a single cavity, in which is contained the nourishing pulp, or model, as it were, of the tooth. The tooth itself is exceedingly soft. The rudimentary fang, which we shall consider as next in succession, because next in size, has already assumed a different appearance. At its base may be seen a part of the anterior opening, or that through which the poisonous fluid is afterwards to pass: this little cavity or opening already contains a pulp. The third tooth, reckoning always by the increasing size, shews a much more complex structure, for the tooth growing continually from its base, the anterior opening is entirely formed. The external and convex cortex of the tooth has become consolidated immediately behind the opening; but near the base a line may readily be perceived, extending to the soft parts at the base of the tooth itself. This line, in some teeth, strongly resembles a fissure; but I have never found it to be really so, in the rattle-snake, or in the fangs of those serpents which, by reason of their size, could be easily examined. It is not improbable that, during the very early and soft state of the tooth, it may be partly open. As the tooth grows, the enamel on its convex external surface closes constantly behind the anterior opening, and advances gradually towards its base; whilst, at the same time, there arises a firm, horny, or osseous lamina, which, proceeding from the convex surface of the poison-canal, divides the external cavity, or that containing the nourishing pulp of the tooth, at this point, and, indeed, throughout its whole length, into two equal parts. A section, therefore, of a tooth, at this stage of growth, will present a variety of appearances, depending on the situation of the section. If

made at a short distance from the anterior opening towards the base of the tooth, there will be seen, first, the central osseous canal, the future channel for the poison, but which is in the present stage filled with its nourishing and formative pulp or mould; 2*d*, A circular space surrounding the poison-canal, inclosed by the external parietes of the tooth, and containing also its nourishing pulp; 3*d*, A vertical osseous or horny lamina, proceeding from the convex side of the tooth to the poison-canal, and dividing this cavity, superiorly, into two equal parts. But immediately behind the anterior aperture, the convex part of the poison-canal has united so firmly and closely with the parietes of the tooth itself, that the vertical lamina is scarcely discernible. The reason of this is, simply because the poison-canal presents throughout a calibre of nearly equal dimensions, whilst the tooth itself is constantly becoming more and more tapered towards the point; the parietes, consequently, of the respective canals soon approach each other, and at last are united; the cavity, also, for containing the nourishing pulp of the tooth, becomes gradually less and less, and is more confined to the concave side of the tooth. If the section be made near the base of the tooth, that is, where the enamel has not become consolidated, the vertical lamina is quite cartilaginous, and very thin, but always exists; *so that the external nourishing pulp at no period of the growth, uninterruptedly surrounds the poison-canal.* Moreover, it is here to be remarked, that *the poison-canal is never open on its convex surface*; but that, on the contrary, its parietes form at all times a completely circular canal, containing at an early period its formative pulp, and, afterwards, poisonous fluid itself. The fissure which, at a very early period of the growth of the tooth, may be seen on its convex side, is quite closed, even in the rudimentary fangs, long previous to the formation of the aperture at the base;

and the vertical or ascending lamina is in consequence completely formed. The convex surface, moreover, of the poison-canal is at all times stronger and more compact than the lateral or concave portions. In one of the preparations now before me, there is an appearance indicating that the vertical lamina becomes first ossified on the side of the poison-canal.

The opening at the base, by which the poison is at a future period to pass into the poison canal, is formed in a similar way with the anterior aperture or-outlet, yet there are certain differences arising out of the functions which the tooth must afterwards perform. The principal of these is the imperfect state of the aperture at its base, which can scarcely be called complete, and, indeed, is in some measure rendered so only by its insertion into the maxillary bone. Anterior to, and on the sides of, the aperture, at the base of the fang, the external parietes of the tooth becomes very strong; they are firmly united to the edges of the poison canal, and consequently, the greater portion of the nourishing pulp of the tooth is thrown towards the concave side; but there still exists a very thin layer of pulp on the sides and lateral convex aspect, *excepting always in the site of the vertical lamina, or uniting plate of the two canals.* As the fixed fang is detached by a process which I shall immediately endeavour to describe, the rudimentary one, which has now attained its full growth (though not its hardness), becomes gradually fixed into the cavity on the lower surface of the upper maxillary bone, externally or internally, and by adhering to the edge of this bone, and, at the same time, advancing forwards, the source of nourishment of the pulp belonging to the poison canal is cut off, the portion of pulp at the time in the canal dies and wastes away; and thus, for the first time, the osseous tube destined to give passage to the poisonous secretion becomes pervious.

But it is carefully to be kept in mind, that this osseous tube *has neither furrow nor fissure, but is at all times complete*. It is probable that, in the mean time, the other tooth is detached, in order to be thrown off, by a process exactly similar to that by which the poison canal is formed; but the process of decay and renovation, or the loss of one tooth and its replacement by another, does not seem to be in any way influenced by mechanical laws, or to be necessarily connected with each other as cause and effect, for I discovered and carefully preserved the head of a common viper, in which there are two fangs firmly implanted into one maxillary bone. It would seem that the replacement of the teeth takes place at fixed, though unknown, periods. The sections of the full grown tooth present certain differences from those described in the rudimentary ones; if we commence, for example, near the base, and cut the tooth across, in the situation of the opening at the base *, it will seem as if the poison canal opened on the convex surface; but at every point anterior to this, or towards the point of the fang, the section will present a complete central hollow tube or canal, nearly circular, surrounded, excepting at one point, by a pulpy matter (itself inclosed by the external parietes of the tooth), and therefore not continuous, being separated on the convex side of the tooth by an osseous vertical lamina, connecting the poison canal and external containing case of the tooth together.

The rudimentary teeth are found to vary in number, which may probably depend on the age of the animal. In the common Viper of this country, and in the Puff-Adder of Africa, I have generally found five; in other venomous serpents, four; in the Rattle-Snake, five; in some Cobras,

* See the Figures in Plate X.

three ; &c. It is chiefly in the teeth of the Rattle-Snake * that I have observed the facts detailed in this paper, but I have also noticed the same appearances in some others, more particularly in the head of a large serpent, said to be Indian, but closely resembling the African Puff-Adder. In some of the larger Cobras, the same appearances present themselves, but it is more difficult distinctly to make them out, by reason of the smallness of the poison fangs compared with those of the Rattle-Snake. I have thought, from some specimens examined by me lately, and more particularly, from the one I now present to the Society, that the apparent fissure extending along the convex surface of the fangs in the Rattle-Snake may be forced open mechanically, even in the fixed fang, (for I do not suppose that there is ever actually a fissure in the fang of the Rattle-Snake); still there is no appearance of the poison canal ever being open on its convex surface †. The teeth in this serpent are extremely brittle, and split longitudinally, whenever we attempt to cut them.

The figures in the attached drawing are intended to explain most of the anatomical facts mentioned in the paper: they were sketched from preparations now in my possession.

* *Crotalus durissus*.

† It is easy to satisfy one's self of the accuracy of this, by paring away the concave part of the tooth, and of the poison-canal, and examining the inner surface of the remaining convex portion; it will then be quite evident that the poison-canal is never open on its convex side, excepting in the situation of the openings, for the entrance and escape of the poison. The vertical lamina, and its firm union with the parietes of the tooth and of the poison-canal, is best seen by paring away the sides of the tooth, and leaving the convex part and the whole of the poison-canal entire.

—◆—

Explanation of Plate X.

- Fig. 1. Shews the tooth of the Rattle-Snake at an early stage of its formation. The line marked *a*, on the dorsal or convex side of the tooth, is already completely ossified.
- Fig. 2. The tooth farther advanced in its growth. The line, or supposed fissure, is firmly ossified at *a*, that is, near the anterior aperture of the poison-canal; but even at *b*, where the parietes of the tooth are quite cartilaginous and soft, the line is not open, but perfectly closed. *c* marks the soft parts at the base of the tooth.
- Fig. 3. A portion of the external parietes of the tooth has been removed, by which the cavity (*a*) containing its pulp is exposed. *b* marks the vertical or ascending lamina, uniting the poison-canal on its convex side to the inner surface of the parietes of the tooth. At no period is the poison-canal open, but at its extremities.
- Fig. 4. The tooth of the Rattle-Snake in a still more advanced state of growth. The aperture at the base, for the admission of the poison, is just formed; but the line on the convex surface is closed throughout, even at *b*, immediately anterior to the aperture.
- Fig. 5. The tooth fully formed, but not yet fixed. A portion of the external parietes and pulp has been removed, exposing the poison-canal, *a*. The nourishing and formative pulp of the tooth is found chiefly on the concave side, at *b*. *c* marks the aperture at the base.

Fig. 8.



Fig. 7.



Fig. 6.



Fig. 5.



Fig. 9.

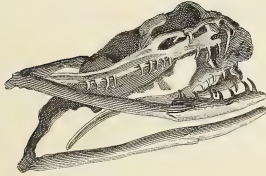

Fig. 3.



Fig. 2.



Fig. 4.



Fig. 1.



MAP
SHEWING THE DISTRIBUTION OF THE
ALLUVIAL DEPOSITES
IN THE
DISTRICT OF THE FORTH

W. H. Lizars sculp^t



- Carse Clay
- Sand & Gravel
- Mosses

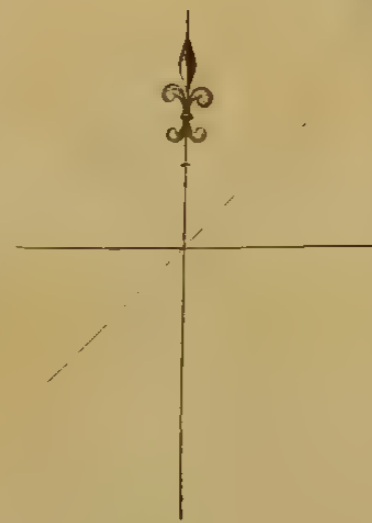

traversing with rapid currents the *old red-sandstone*, as expressed on the annexed Map (Plate XI.) enter the margin of the clay about one mile before they join the Forth. The former transmits about as much water as the Forth, the latter considerably more than that river*.

The district of the Forth may be divided into upper and lower, separated by the gorge at Stirling, formed by approximation of the hills, narrowing the carse-ground or valley to one mile. The rocky substratum of the upper district consists, probably throughout, of the old red-sandstone, which, dipping southwards, is lost under the clay and subordinate gravel, which occupy the valley. This arrangement is presented by the sections formed by the Teath, Allan, and Forth, and tributary streams; also at excavating the ornamental river, and in forming the elevated aqueduct at Blair-Drummond, passing from the higher marginal gravel, and proceeding into the clay of the valley.

This extensive upper district presents to the eye one uniform plain, the central parts occupied with mosses, whereof large portions have been floated off to the river by means of water introduced for that purpose, into which the peat-earth is thrown, so as to leave the clay fit for the purposes of agriculture. During these and other operations the nature of these mosses and subsoils has been unfolded. The clay of this district, presenting a uniformity of surface, is of varied quality. In so far as exhibited, by a very few deeper operations, its depth does not exceed twenty feet. Stones and pebbles of any description are unknown through its whole extent, but it reposes on small gravel, sand, red

* This map is formed on the principles pointed out in a paper by the President of the Society, printed in Vol. I. of their Transactions; the exterior line, of a deeper tint on the margin of each colour, expressing that the particular stratum reposes on the one contiguous.

till, or red *tilly* earth, as the case may be, which rest on the old red sandstone.

The mosses alluded to have preserved the remains of an ancient forest, chiefly oak-trees, which had occupied the plain but little above the surface of the river during ordinary floods, part whereof appears to have been lower and marshy, across which a road had been formed of trees laid longitudinally, with a second layer transversely. The depth of Blair-Drummond Moss (in which this road occurs), prior to the operations, was eight feet, extending to fourteen towards the upper extremity. Some of the roots of the trees were very large, and occupied their natural position in the soil, their trunks being extended horizontally, many retaining distinct impressions of the axes employed in felling them;—an operation commonly referred to the period of the Roman Conquest*.

These remarks on the upper district apply equally to the lower district and its mosses. But although the carse-clay soil presents in both the appearance of an extensive level plain, it is perhaps nowhere perfectly horizontal. It contains depressions, elevations, and inclined planes, which, to a certain extent, seem to have modified the course of the Forth, assisting in the formation of those meanderings which distinguish it, and which, particularly on the exterior margin of its numerous circular sweeps, encroach on the higher banks, presenting perpendicular sections on that side, and leaving low ground on the opposite, commonly embanked against the higher tides. In the lower district, the carse-clay has been remarked from 30 to 70 feet in thickness, at sinking wells near Stirling and Bothkennar. It reposes on sand, gravel, dark-blue *till*, or immediately on rocks of the Coal Formation. In both districts, the

* See "Encyclopædia Britannica," article 'Moss.'

sand, gravel, and till-clays, emerge from under the carse-clay at its margin on all sides, ascending often to an elevation considerably above it, forming knolls, ridges, and inclined planes. On the Map, the carse-grounds are expressed by *yellow*, the sands and gravels by *pink*. The bounding line is discontinued at those points of the last, where particular observation has not been extended.

On digging these wells sundry vegetable remains were observed, consisting of wood, hazel-nuts, and leaves of trees, in good preservation, occurring at various depths, interstratified with large gravel, clay, sandy clay, and sand, the last furnishing abundance of water, to which the clay may be considered as impervious. There are similar appearances at Drip, in the upper district, in passing fourteen feet through the clay into sand, reposing on the margin of a knoll of red sandstone. At Alloa, also, timber and other land products occur in sinking pit-shafts through the carse-clay to the coal-rocks. In that quarter, and at the mouth of the Carron, some transference of the soil may be supposed to have occurred, and a portion of the soft clay, or sludge, uncovered at every tide, may have been deposited in natural hollows. At Alloa, the tides form rapid currents during a portion of every efflux and reflux. But in other places, where the surface presents small depressions, not exposed to be flooded by any considerable stream, the clay immediately under the vegetable mould is a fine tint of blue, indicating that it had suffered no disturbance or mixture. Of this description, at B on the Map, occupying a small plain on the margin of the Carse, slightly depressed, is that in which the skeleton of the whale was imbedded, at Airthry. Hardly above the level of the river, from which it is separated by more elevated ground, a small rill passes from the adjoining hill, which, stagnating, may have produced the covering of peat-earth, much thinner than the

mosses of either district. I have particularised these hollows, because in the points which were at all seasons free from flooding, the roots of vegetables, with the operations of insects, producing a more spongy texture, and affording access to the influence of the sun and air, a more equivocal description of clay is presented, approaching to vegetable mould. Undisturbed clay is further indicated by alternating thin parallel layers of blue and brownish clay, in which occur, in both districts, many extensive deposits of marine shells, disposed conformably to the layers. Their localities, with other remarks applicable to the general subject, shall next be noticed.

SP. 1.—Below Polmaise, the south bank of the river presents sundry sections of the carse-clay. Near Fall-in, is a section of 14 feet: under the soil-cover, 8 feet of the alternating stratification, formed by extra proportion of quartz-grains, oxide of iron, and mica-scales; declination E. 5° . Beneath this, a layer of shells occupies the clay, from 6 to 8 inches in thickness, same as in specimen. It also contains in abundance the roots of *paddock-pipes* (the *Equisetum*), which plant is frequent in the surrounding fields. These roots do not appear under this layer. Some of them penetrate into the interior of the shells. Under this lies a conformable stratum of peat-earth (14 inches), sides parallel, containing numerous fragments of the rind of an aquatic reed, compressed longitudinally; also small pieces of wood, and fragments of bark; but no trace of the moss-plants, or bog-plants, which form the superficial mosses of the valley.

SP. 2. is from this stratum, situate 6 feet above high-water mark: under it lies a more compact and bluer clay. Eastward 300 yards, the bank presents a similar disposition, with declination E. 3° . In all these the shells consist of the kinds most common in the Frith and sea-coast. Many of the bivalves occur shut and empty, excepting a

Fig. 3.

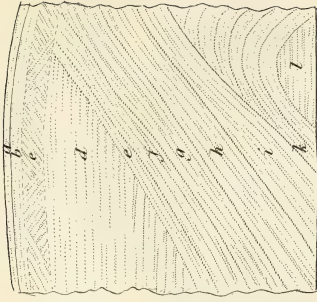

Fig. 6.

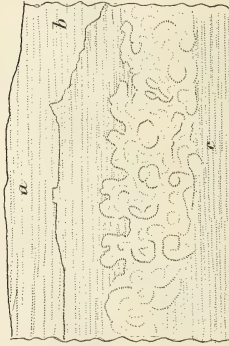

Fig. 2.

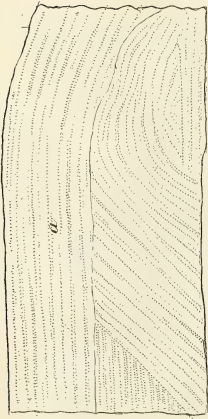

Fig. 5.

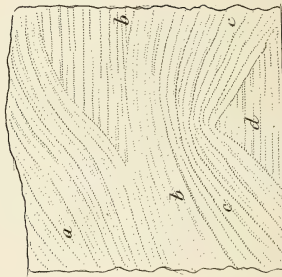

Fig. 7.

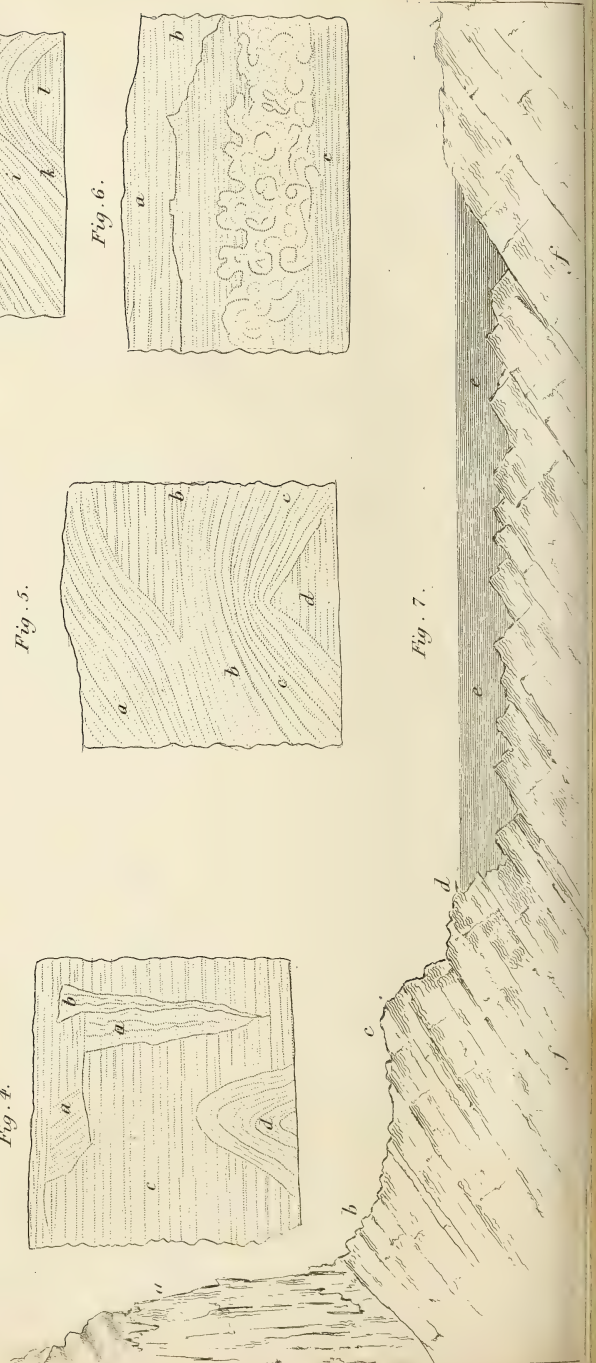

Fig. 1.

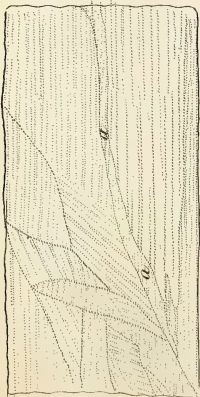
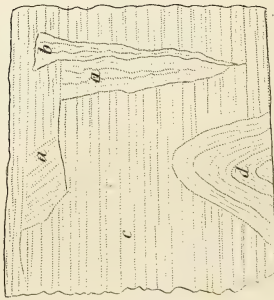

Fig. 4.



minute portion of orange-coloured matter. Similar remarks apply to the shells of the upper district.

SP. 3. Clay immediately over the shell-layer. The general features of this lamellated clay under high-water mark are shewn in Fig. 1. Plate XII.

SP. 4.—Clay from *a a* being darker when recent, than the adjoining. The colours refer to its appearance, when *moist*, Fig. 1.

SP. 5.—Shells from clay-section of 10 feet, formed by the river at Ross, opposite Meiklewood, upper district, included in eight parallel layers of the clay, occupying about as many inches. The layer immediately under, so closely resembles clay-ironstone in colour, and angular *fracture* (if the term be admissible), that it might be, at first sight, mistaken for it, although but little harder than the others. Dip 3° N.; declination 2° E., descending more rapidly at the east end, where it presents the following general features: Fig. 2.

a, Position of shell-layers.

SP. 6.—Shells found in abundance in surface-drains at Drip farm. Shells similar to these are found in the carse-clay at many other places, some of them ten miles farther up the valley: Also in the lower district, at Grangemouth, in strata 12 inches in thickness, which crop out in sundry places.

The following Specimens and Remarks relate to the Sand and Gravel Deposits which appear on the margin of the Carse-Clay of the Lower District.

At Ballasthill sand-pit, near Canal-bridge, Falkirk, a knoll of sand and gravel is wrought for ballast, and presents a section about 40 feet by 300 in length. Towards the

right it is in depth 20 feet, and passes into blackish clayey earth, the upper part ochreous. Twelve yards farther, its upper portion passes into clayey till, and its under into very compact till; colour almost black, without pebbles, and impervious, naturally dividing into rock-like fragments.

SP. 7.—Into this *till* the orange-coloured ochreous matter passes horizontally, 1, 2, and 3 feet, in veins, which, commencing $\frac{2}{8}$ ths or $\frac{3}{8}$ ths of an inch in thickness, with well-defined edges, proceed in an angular or zigzag course, tapering to their extreme points. In dimensions, shape, and common direction, they correspond; but their angles are all dissimilar.

SP. 8.—A selection of pebbles from the knoll, including the varieties. There are no traversing veins or slips. Many of the stones are rolled spheroids, chiefly soft coarse sandstone, of an earthy-brown colour; and from six to twelve inches in diameter. Yet the interior features of this knoll are manifestly regular.

SP. 9.—*Fine* sand from the knoll.

SP. 10.—*Sharp* sand from the knoll, grains larger.

The following sketches, taken on the spot, will serve to shew the general structure presented by the remainder of this section. The lines express the larger features, parallel to which the filmy aggregation of the materials is arranged. Some of the pebbles are enveloped in a thin calcareous crust, attaching those contiguous.

Fig. 3. Near centre of section.

- a*, Soil.
- b*, Small gravel and ochre; brown earth.
- c*, Sand; alternate layers, ferruginous.
- d*, Small clean gravel.
- e*, Sand and clayey sand.
- f*, Large gravel.

- g*, Clean small sand.
- h*, Large gravel.
- i*, Sharp large-grained sand. Sp. No. 10.
- k*, Sand and clayey sand-belts.
- l*, Clean small gravel.

Fig. 4. To right of preceding, at transition into tilly earth.

- a, a*, Sand.
- b*, Gravel.
- c*, Gravel.
- d*, Gravel.

Fig. 5. To right of preceding.

- a*, Sand and gravel.
- b, b*, Gravel and sand.
- c, c*, Sharp sand.
- d*, Fine sand.

Eastward from this point there are similar knolls of gravel, on both sides of the Edinburgh road, for some miles beyond Falkirk: Likewise on the opposite margin of the valley, along the foot of the Ochil Hills.

SP. 11. & 12.—The sand-pits of Carron Company are of considerable dimensions. The following is a sketch of pit west of Carron-House, depth 10 feet.

Fig. 6.

- a*, Small gravel and sand, with coal, grains size of a pea to an inch.
- b*, Sp. No. 11.
- c*, Sp. No. 12.

To the west it passes into fine blue clay; which again passes into dark-blue *till*, a compact gravelly clay, described in the paper already referred to. North of Carron-House is a large pit; the upper stratum contains semicircular curved lines; open side uppermost; diameter 5 feet, pass-

ing into small gravel-cover. The scarp of the ridge, formed by these knolls, fronts S. This sand-ridge, reposing on impervious *till*, is traversed by oozing hollows, in which some peat-earth has been formed, and is accumulating, from decay of moss-plants. Its recesses assume the form of small bays, one of which contains the Carron Foundry's reservoir. No shifts nor traversing veins have been remarked, and the layers are nearly horizontal.

At Spittalcroft, on the south side of Stirling, there is an extensive sand-pit. The same kind of sand extends to the greenstone rock at the town-walls.

SP. 13. from gravel cover.

SP. 14. sand immediately under. Like those already noticed, this sand contains granular coal, and exhibits shifts at veins traversing the layers. The matters of which it is composed serve to shew its relations. Its predominant colour is reddish-brown.

SANDS AND GRAVELS OF THE UPPER DISTRICT OF THE FORTH.

SP. 15. Above the village of Doune, the gravel exhibits calcareous incrustations. At Ashmill Bridge, south of Teath Bridge, a small knoll presents all the general features of the sand-hills of Edinburgh. Depth of section 8 feet.

SP. 16. Small-gravel cover, mixed with ochreous earth.

SP. 17. Clean gravel and sand under the cover.

SP. 18. Sharp large-grained sand.

SP. 19. Finer under it.

SP. 20. Very fine from bottom of section. All these are separated by well-defined lines of contact, and are not hori-

zontal nor parallel. The sand under the gravel *cover* exhibits the counterpart of those peculiar wavy horizontal lines remarked in corresponding situations in the Edinburgh pits: A mile farther, on the banks of the Teath, and 20 to 30 feet above its surface, the sand occurs similarly arranged. Here the river flows rapidly over red sandstone.

Sp. 21. A little east of Ashmill, at Merlin's Ford, in Blair-Drummond policy, a bank of fine micaceous sand skirts the valley. The small-gravel *cover* under the vegetable mould is of several feet. It passes in sundry places into the subjacent sand betwixt two traversing veins, the section presenting the trumpet-form, mouth upwards. Minute shifts are common, at traversing veins. The general form is *knolled*. It reposes on red till, and the traversing hollows are spongy. The common dip is SW., being contrary to the surface in that direction, which rises into considerable swells of red till, reposing on red sandstone.

Twenty feet lower, is an oblong level field of 100 acres, with a slight declination to SW. On the N. is a steep scarp, 20 to 30 feet, the substratum gravel, composed chiefly of spheroidal sandstone, sometimes united by a black or pitchy base. This substratum transmits much water in spring. At the upper extremity of this field, the gravel terminates betwixt two ridges of old red sandstone, covered with red till, clayey earth, sand, and small gravel. Its opposite extremity passes under the carse-clay. The river Teath here forms the north boundary of a tongue of higher land, terminating at Blair-Drummond; the southern bank, stretching westward on the margin of the carse-clay, is composed of *till*, high and precipitous, surmounted with small-grained micaceous sand, many yards in depth, passing on the north into siliceous sand and gravel, exhibiting the common forms of arrangement. (This bank thus forms the counterpart of the one which passes by Merlin's Ford). Three or four

miles farther west, the quarries of old red sandstone on the margin of the valley shew, reposing on the rock, fine sand with the usual *regular forms*; over which, under the soil, a few feet of wafer-like scales of the sandstone, with sand intermixed.

In general, it may be remarked, that the granular coal, bituminous shale, and other products of the coal-formation, do not appear among the sands and gravels of this upper district, which have now been described. But the specimens manifest the presence of sundry pebbles of the transition-rocks; also of mica-slate.

OLD RED SANDSTONE OF UPPER DISTRICT OF THE FORTH.

This appears, on its lower boundary, at Airthrey Mines, Bridge of Allan, Cruives of Craigforth, Dripfarm, and Redhall. It also forms Naad Knowe, a conical knoll, elevated above the Carse. The common dip and direction of the sandstone at all these points corresponds with that exhibited in the channel of the Teath and the Allan. This rock appears also within a few yards of Craig-forth, a mass of greenstone, which, rising through the Carse, presents, on one side, a perpendicular precipice. Here the sandstone is traversed by veins of greenstone, which may be seen in the bed of the Forth, and on the north side they were several yards in thickness, in the quarries for the roads. These last veins were of several yards in thickness.

The writer of the article *Perthshire*, in the Edinburgh Encyclopædia, states his opinion, that the Transition red sandstone is bounded on the south by the Ochil and Campsie Hills. I have marked on the map what appears to be its course on the south. From Redhall, in the direction of

Kippen, the red sandstone stretches along the north front of the Campsie Hills, commonly called Gargunnock Hills. At Boquhan, it is traversed by a torrent of that name, at a natural ravine, cutting it obliquely to a considerable depth. (Similar sections at Leckie and Gargunnock.) This red sandstone, like that on the north side of the valley, is covered by red till or tilly earth, with dip and direction also conformable. It presents a precipitous front to N, and the rivulet exhibits the succession of strata betwixt it and the perpendicular front of the Campsie Hills, over which it is precipitated at Balloch Leam. The rocks of the intervening hollow are conformable to the sandstone, of varied characters, and alternating until they reach the foot of the mural precipice of greenstone, which is rudely columnar. They are traversed by *veins* of greenstone connected with this stratum of greenstone.

SP. 22. is from these strata. I was therefore led to the conclusion, that this red sandstone is a continuation of that on the north side of the valley,—that it passes *under* the Campsie range, at a small dip,—that the superincumbent strata accompany it,—and that, in place of the Campsie Hills reposing on coal (as supposed by Colonel IMRIE), *that* substance will only be found recumbent on their southern and eastern extremities. The diagram, Fig. 7. will assist the description.

a, North front of Campsie Hills*.

b, Subordinate parallel strata.

* The view from the north side of these hills is singularly beautiful. Rising perpendicularly, the valley appears as beneath the feet; beyond which its wide margin (*braes*) appear expanded and converging, studded with the seats of landholders, and strewn with farm-steads, as far as the eye can distinguish; the cultivated uplands extending northwards till they meet

c, Stratum of red sandstone.

d, Alveus of Forth.

e, Carse-clay resting on sand and gravel.

f, f, Red sandstone, as supposed.

The Map contains a general delineation of the boundaries of the carse-clay, gravels, and old red sandstone.

SP. 23. consists of carse-clays. The *lamellar* is from the section on the Teath, near its junction with the Forth. Similar appearances are presented at other points; the thin filmy layers of clay, with still thinner of fine quartz-sand interposed, admitting of separation, when recent. The exterior boundaries and relations of the tills have not yet been fully examined.

28th October 1823.

those of Strathearne; towards the left, the Grampian range of mountains crowns the prospect, here presenting their boldest front. In very clear weather the eye penetrates into the dark-blue and deep recesses of their many narrow glens, contemplating every feature of their varied, erect; and magnificent forms, so closely grouped as to suggest the idea of an immense *forest of mountains*, rather than the more common and cumbrous aspect of hills, and particularly when their lofty summits, elevated from 3000 to 4000 feet above the valley, are capped with snow.

On the right, are Stirling Castle, and the finely shaped Ochils, whereof *Dunmyat*, the most westerly, has been justly noted for its fine prospect, although probably in some respects inferior to this.

APPENDIX,

REGARDING BONES OF WHALE RECENTLY DISCOVERED IN
UPPER DISTRICT.

(Read 4th December 1824.)

THESE bones have occurred seven miles west from those found at Airthrey, at A in the Map, on the estate of Blair-Drummond, and fifteen miles farther up the valley than those recently discovered in the clay at Dunmore. I am authorised to state, that they will be presented to the Museum when fully traced. Meantime, it may be remarked, that they were situated within 400 yards of the margin of the carse-clay, in which they were imbedded at a depth of 4 feet.

Under this clay, there is a stratum of black spongy peat-earth, closely resembling that already described at Fall-in. It is specifically heavier than water. Its colour nut-brown, changing to deep-black, within five minutes after exposure. In drying it shrinks greatly, and, being smoothed, presents a glossy surface. Exposed to a red-heat it emits a penetrating odour, and is slowly reduced to ashes, which are ponderous, and promptly obey the magnet. This peat-earth is here 6 feet in thickness, and is penetrated vertically by the roots of the *Equisetum*. It rests on clay, containing a large proportion of fine sand. The organic remains in this earth consist of pieces of fibrous vegetable matter, the same as observed in the corresponding mossy stratum already noticed; these are an inch to two inches in length, and from one-fourth to an inch in breadth. Their general position is horizontal or parallel with the stratum, and they are com-

pressed in that direction. Some are placed obliquely, and are, in like manner, flattened. Their surfaces are smooth and glossy. Longitudinally, they are somewhat tough; and, under their black hue, a tinge of greenish-yellow may be perceived. Many of these fragments include joints, from one extremity of which, frequently, slender roots extend; which marks them, according to my apprehension, as being the same with one of the aquatic reeds common in the district, which sends out roots in a similar manner from the lower joints. Fragments of small branches and twigs of birch are also apparent,—of the last, the cortical and medullary portions only remaining; also alder, or perhaps poplar, and thicker portions of another, soft and destitute of bark, resembling the roots of furze. Small, vesicular, flat, oval, greyish seeds, have been detected,—with others of same form, black, attenuated, and opened; considered by botanists to belong to the genus *Pedicularis*. A specimen of the stratum is herewith sent, and also of the superincumbent clay, with moss, from the lowest layer of Blair-Drummond, and of the common superficial moss of the valley. (Sp. 24, 25, and 26.) In superficial mosses, the lowest layer is most decomposed, more compact, and of a deeper black. The imbedded bones emit a strong odour by heat, as of rancid fish-oil. The stratum of black spongy earth on which the bones reposed, dips gently towards the east; and, in this particular also, agrees with the stratum at Fall-in. No trace nor odour of the contiguous clay is discernible. A few hundred yards to the west, it crops out; and, till lately, formed an obstruction to cultivation, after the superficial moss which covered it had been removed; but it has been rendered arable by a judicious use of *wedge-drains*, adapted to afford an exit for the water which proceeds from the substratum of sandy clay. The tenant remarked, that all this last is *jointed* like a rock, and

transmits water upwards through the seams. The rock-like structure of this substratum corresponds with what was remarked at Fall-in; and the specimens from that quarter exhibit a similar redundance of sand. It also corresponds with what appears at every deeper section of this extensive clay-field, which probably all reposes on sand and small gravel.

At this point, the surface of the clay declines towards its margin. The same has been frequently remarked along all the verge of the Carse districts, and is particularly apparent where the form of the adjacent rising grounds presents the resemblance of small bays on the margin of the valley. In these the clay-soil is observed to be of a superior quality, for agricultural purposes.

ALLAN-PARK, STIRLING, }
15th October 1824. }

XXV.—*Notice regarding Fossil Bones of a Whale discovered in the District of Monteith.*

By H. H. DRUMMOND, Esq. of Blair-Drummond.

(*Read 4th December 1824.*)

IN October 1824, the remains of a whale were found in the barony of Burnbank, which forms part of the estate of Blair-Drummond, at a place about three-fourths of a mile distant from the parish-church of Kincardine, in Monteith, and nearly a mile from the present course of the river Forth. The ground where the bones were found had been originally covered with peat-moss, which was a good many years ago floated into the Forth, in the course of the improvements of that nature which have been so successfully and so extensively practised on that estate. The soil under this moss, is what is very well known by the description of Carse-clay, and it was in digging a ditch in the clay that the bones were found. The clay at this place is only four feet deep, as it is near the outer edge of the carse-land where it approaches the surrounding banks, which, in the language of the country, are all termed “dryfield,” of whatever description of soil they may consist, in contradis-

tion to the carse-land, which, from its flatness and retentive quality, is naturally wet and swampy, until drained, for the purposes of agriculture. In general, as the carse-land recedes from the Forth, and approaches the dryfield, the stratum of clay becomes gradually thinner; and in many places a stratum of moss comes to the surface, near the margin of the dryfield, which dips under the clay towards the Forth. It was upon the surface of this second and lower stratum of moss, below the clay, that the bones were found. They were embedded in the clay, and did not penetrate at all into the moss below.

The bones found, and which are now deposited in the Museum of the College of Edinburgh, consist principally of a large portion of the cranium, comprising the occipital bone and foramen, frontal, a part of the superior maxillary, &c. There were also a scapula and several vertebræ, though in a mutilated state.

It is a very singular circumstance that, along with these bones, there should have been found a fragment of a stag's horn, similar to that found along with the Airthrey whale, and having a similar round hole bored through it. This piece of horn is also deposited in the Museum. A specimen of the stratum of peat-moss under the clay has been sent to the Museum, along with the bones in which the remains of wood, particularly alder, and of various water-plants, will be distinctly seen. The stratum was found to be six feet deep, and under it bluish sand was found, with little or no admixture of clay.

XXVI.—TENTAMEN METHODI MUSCORUM;

OR,

*A New Arrangement of the Genera of Mosses,
with Characters, and Observations on their
Distribution, History, and Structure.*

By R. K. GREVILLE, LL.D. F. R. S. E. M. W. S. &c.,

AND

G. A. WALKER ARNOTT, Esq. A. M. F. R. S. E.

(Continued from p. 89.)

(Read 22d January 1825.)

MEMOIR III.

SPLACHNOIDEÆ, *Gen.* (11—13.)

CHAR. CALYPTRA mitræformis, basi thecam arcte cingens, mox dimidiata, lævis, glabra, tenerrima, fugax, basi integra. Seta terminalis. Theca apophysata. Operculum obtusum. Peristomium simplex; dentes varie geminantes. Columella apice dilatato-globosa.

CHAR. Calyptra mitriform, closely embracing the theca, at length dimidiate, even in surface, smooth, thin, evanescent, entire at the base. Seta terminal. Theca with an apophysis. Operculum obtuse. Peristome simple; the teeth variously geminating. Columella capitate.

Obs. So strongly and so conspicuously do the individuals composing this well-marked group resemble each other, not only in external habit, but also, for the most part, in intimate structure, that it is extremely difficult to establish genera, or subgenera, referable to it, upon well-grounded characters. Various ones have been proposed by the most eminent botanists, as, in the progress of their examinations, they have detected different situations, arrangements or directions, of the teeth of the peristome, or some other apparent peculiarity connected with the fructification. Thus we have *Aplodon** of BROWN, in the Appendix to PARRY's first voyage; also *Cyrtodon*† of the same author, proposed in the observations under *Aplodon* in the same work; both of which are removed from *Splachnum*. Mr BROWN has also suggested that *Splachnum Frælichianum* and *S. Wulfenianum* might with propriety form a subgenus, on account of their inclined capsule and erect teeth.

In the present paper we have carefully examined almost every recorded species and variety in the Order; and though we do not pretend to any original discovery, we have endeavoured, by generalizing our observations upon well-grounded data, to establish our genera on what we conceive to be more tenable, and even more natural, characters. The whole has been done under the highest respect for the talents of those able botanists and philosophers who have conferred additional importance on muscology, by devoting their time and knowledge to its illustration.

* This genus was formed to receive a single species, the *Splachnum Wormskioldii* of HORNEMANN.

† This genus is composed only of *Weissia Splachnoides* of THUNBERG and of SCHWÆGRICHEN.

It is necessary to state, that our views respecting the *structure* of the peristome are essentially the same as those which Mr BROWN has so admirably detailed in the twelfth volume of the Linnean Transactions, p. 577, *et seq.* That excellent muscologist has there expressed his opinion, that the semi-pellucid lines, or longitudinal striæ, at least denote a “tendency to division in the teeth where they are found.” He also considers the prevailing number of teeth in the outer peristome of mosses to be thirty-two; “though, by a coalescence, more or less complete, they are frequently reduced to sixteen, in some cases to eight, and in a few even to four.”

“According to this view,” continues the same learned author, “a single longitudinal line in the axis of a tooth, indicates the confluence of two teeth; three equidistant lines, one being central, the coalescence of four; and seven lines, similarly disposed, that of eight.”

“Nearly the whole of these modifications exist in that natural subdivision of the order, which may be named *Splachneæ*, consisting of *Splachnum*, *Systylium*, *Tayloria*, *Splachnum squarrosus** of HOOKER, and *Weissia Splachnoides*.”

“The number of teeth in *Splachneæ* is thirty-two; which, however, are never entirely distinct, and at the same

* This plant has been subsequently published, and figured, by Dr HOOKER, as *Octoblepharum serratum*. However, from the calyptra of *O. albidum* being dimidiate, it must now retain the name of *Orthodon*, given to the genus by BORY DE ST VINCENT. Mr BROWN has drawn up its generic character in Linn. Trans. vol. 12. p. 597.

As we have had occasion to notice this species here, we may take the opportunity to mention, that we do not conceive it to belong very satisfactorily to the *Splachnoideæ*, and therefore we shall defer what we have to say concerning it to a future memoir.

time equidistant, but approximated or united in various degrees in the different genera and species of the section."

As it is most desirable in every science, and especially in that of muscology, to have the technical terms well defined, and their meaning limited to their respective objects, we shall here explain what we hold to be signified by the terms, *dentes geminati*, *dentes geminantes*, *dentes fissi*, and *dentes per paria approximati* *.

The *dens geminatus* is a tooth which appears to be a single one, but which is marked by a longitudinal semi-pellucid line, denoting a tendency to separation, and often actually producing a separation; the line must therefore extend from the apex to the very base, and might be called with propriety the *linea separabilis*. There are thus actually two teeth, which, when united, are called a once-geminate tooth, and, when separated, two geminating teeth.

The *dentes geminantes* are a greater or less number of teeth longitudinally coalescing, the number of teeth so united being shown by the semi-pellucid longitudinal striæ. The whole is called a tooth, which is farther characterised by being once, or twice, or four times, geminated.

The *dens fissus* is not provided with a *linea separabilis*:

* From the confusion that has been created in consequence of the want of a general understanding on this point, the reader will readily concur in the necessity of a reformation of terms. The uncertainty of the present nomenclature may be exemplified in a few words. HEDWIG, SCHWÆGRICHEN, and others, describe the teeth of a *Splachnum* as "8-geminati." BRIDEL, at first, as "8-paria," and afterwards (as in *S. Magellanicum*) "16-geminati." While several authors apply "*dentes geminati*" to *Splachnum*, they use the phrase "*sedecem paria*" to *Systylium*, and "16 per paria approximati" to *Zygodon* and *Orthotrichum*, the structure of the teeth in all being the same. At the same time, also, "16 paria," or "16 per paria approximati," are attributed to *Didymodon*, *Trichostomum*, and *Leucodon*, genera having a peristome of a totally different nature.

it is a single tooth, cleft or divided more or less from the apex downwards, sometimes even nearly to the base; but at whatever point the division stops, there is no line visible below that point, by which the separation could be continued. The *dens fissus* is often perforated in such a manner, as to prove, that, in many instances, the division is the result of a series of lacunæ. A *dens fissus* should be considered as unity; a *dens geminatus* as a compound. The latter might be called *dens separabilis*, or *dens fissilis*; the former simply *dens fissus*.

The *dentes per paria approximati* are at no period of their growth longitudinally united; they are understood to be always separate, although not equidistant. Thus they must not be confounded with the *dens geminatus*, which is often divided to the very base by the *linea separabilis*.

To illustrate this a little farther, we will take a peristome of a *Splachnum* for examination; and suppose (as often takes place) that two or four of the thirty-two primary teeth are united by longitudinal cohesion. These teeth we would term *uni-* or *bi-geminantes*; and the tooth formed by this gemination, *uni-* or *bi-geminatus*. In several genera, as *Splachnum*, *Orthotrichum*, &c. this structure of the teeth forms a leading character*.

* We are aware, that, in the present state of muscology, we are liable to censure for the introduction of new terms and definitions, and the more so, that it is extremely difficult to define our ideas in express words. Thus several mosses are represented as having a longitudinal line down the middle of their teeth, and yet we have several reasons for doubting if they be really geminated; though a geminated tooth may be only partially divided, and is marked by a line, still we do not intend to assert, in every case where such a line is figured, that the tooth is geminated. It is therefore to be much wished that such as make drawings of the peristomes of mosses, would pay particular attention to this point.

When the *dens fissus* is cleft to the base, or nearly so, it becomes difficult to distinguish it from two teeth *per paria approximati*; and it is not improbable that the latter are, in some instances, nothing more than *dentes fissi*; but little or no confusion can arise from using two names to denote different states of the same structure.

WEBER and MOHR (Handbuch, p. 10.) have some observations under *Splachnum*, much to our purpose. “Hujus et *Orthotrichorum* quorundam dentes non tam *per paria approximati*, sed principio adglutinati observantur. Posthac, imprimis si dentes reflectantur, nexus inter geminos tollitur, et tum primum 16 distinctos reperis. Hac dentium cohæsione et in sicco statu reflexilitate maximopere jam hi musci a *Didymodontibus* peristomio semi-completo gaudentibus, quorum e numero in nostra Flora est *inclinatum*, discrepant, quippe quibus dentes ab initio omnes inter se liberi sunt, et nunquam reflexi. Quare *Splachnorum* et horum *Orthotrichorum* dentes 8 geminati, *Didymodontium* *per paria approximati* dicuntur.”

We have now, finally, to remark, that, in our opinion, it will always be found, when a gemination of the teeth actually takes place, that the peristome, in the young state, forms one uniform undivided, but longitudinally striated, submembranous substance*, which is usually arched over the orifice of the theca; the tendency to split into a definite number of teeth being afterwards developed and regulated by the laws of nature. This idea appears to be corroborated by the fact, that, in the same tuft of specimens, we have repeatedly observed peristomes with six, eight, or twelve teeth,

* This structure, which we attribute both to the *Splachnoideæ* and *Orthotrichoideæ*, will certainly exclude from these orders any of the other species to which some have attributed a geminating line down the teeth.

and this in several species of *Splachnum*; the longitudinal lines, however, invariably denoting the total number of teeth to be thirty-two.

The *Splachnoideæ* differ from the *Orthotrichoideæ* by the capitate columella, by their scariose and fugacious calyptra, which is moreover without furrows, and closely adapted to the theca, until it splits longitudinally, and falls off; the base also is not lacerated. In the *Orthotrichoideæ*, the calyptra is permanently mitriform, loose about the theca, generally furrowed, and pilose; or, if glabrous, it is either lacinated at the base, or with four or five large triangular appendages.



GEN. XI. SPLACHNUM, *Montin. Linn. Hedw.*

FRUCT. *Calyptra* primo mitriformis postea succrescenda theca latere rumpens seu dimidiata, albida vel fuscescens, scariosa, tenera, lævis, glabra, valde fugax. *Seta* terminalis, lævis, plerumque rigida et stricta, quandoque autem tenera, succulenta, pallida; longitudine valde varians sed perichætio semper longior, sæpius solitaria, in una specie aggregata. *Apophysis* matura colorata, vel theca subæqualis vel amplior; obconica cylindrica aut globosa, aut etiam umbraculiformis; plerumque lævis quandoque rugosa, glabra. *Theca* integra, subcylindrica, apophysi brevior, semper estriata, ore absque annulo elastico. *Operculum* deciduum, thecæ subconcolor, obtusum, vel conicum vel hemisphæricum umbonatumque. *Peristomium* simplex e dentibus geminantibus siccitate arcte reflexis constans: dentes primarii (quousque nobis observare licet) 32, ma-

dore æquidistantes, in membranam cupulatam quasi, incurvi, uni- vel bi- vel quadri-geminantes transversim striati; horum geminati siccitate interdum æquidistantes, plerumque per paria quasi approximati. *Columella* exsiccatione plerumque exserta, stricta, rigida, apicem versus dilatata obtusa vel membranæ opercularis rigiditate acuta. *Sporulæ* griseæ, minutæ, globosæ, pellucidæ.

CHAR. DIFF. *Seta terminalis. Theca apophysata. Peristomium simplex e dentibus geminantibus siccitate arcte reflexis. Columella apice dilatata. Calyptra lævis, basi integra, fugax.*

FRUCT. *Calyptra* at first mitriform, at length, from the enlargement of the capsule, bursting on one side, or dimidiate, whitish or brownish, scariose, tender, even, glabrous, very fugacious. *Fruit-stalk* terminal, smooth, mostly rigid and straight, sometimes flexible, succulent, pale; in length varying extremely, but always longer than the perichætium, generally solitary, being aggregated in one species only. *Apophysis* coloured, when mature either about equal to the capsule in diameter, or larger, obconical, cylindrical or globose, or even umbraculiform, glabrous, mostly even, very rarely rugose. *Theca* entire, subcylindrical, shorter than the apophysis, never striated, the mouth destitute of an elastic ring. *Lid* deciduous, nearly of the same colour as the theca, obtuse, either conical or hemispherical and umbonate. *Peristome* simple, composed of geminating teeth, closely reflexed when dry: the primary teeth (as far as our observations have enabled us to decide) are thirty-two in number, and, when in a moist state, equidistant, but so close as to form, as it were, a cupulate membrane over the mouth of the theca; transversely striated, 1- or 2- or 4-geminating: the geminations sometimes equidistant when

dry, but mostly approximated, as it were, in pairs. *Columella*, in the dry state, mostly exerted, straight, rigid, dilated at the apex, obtuse, or, from the rigidity of the opercular membrane, acute. *Sporules* grey, minute, globose, pellucid.

DIFF. CHAR. *Fruit-stalk terminal. Theca with an apophysis. Peristome simple, of geminating teeth closely reflexed when dry. Columella dilated at the apex. Calyptra even, entire at the base, fugacious.*

VEG. The stems vary much in length, and are generally simple, rather slender, sometimes succulent, always erect. The leaves are inserted on all sides, more or less numerous, vasculose, diaphanous, the reticulation extremely lax; in form they have a range from lanceolate-acuminate to broadly ovate: they are also serrated, or entire, usually acute, but in *S. vasculosum* obtuse: all are furnished with a single nerve, disappearing before it reaches the point. The perichætal leaves scarcely differ from the cauline ones, except in being somewhat more attenuated.

OBS. We have already stated, in our observations on the present group, how nearly related are all the genera contained in it. Nevertheless there are no mosses (the Orthotrichoideæ alone excepted) which vary so much in the apparent configuration of the peristome, or rather, in the combinations of its primary parts, when in the dry state. When moist, on the contrary, there are no mosses, the peristomes of which so remarkably resemble each other. In this state, all the teeth are united, as it were, into one mass, usually arched over the orifice of the theca, and divided longitudinally by a definite number of equidistant striæ, by means of which, it is easy, in almost every instance, to

calculate that the total number of teeth is thirty-two: but it is very difficult, if not impossible, to say where the separations are to commence, or how many are actually to take place. This is remarkably illustrated in *S. sphaericum*, in which the line down each geminated tooth, or the *linea separabilis*, appears as strong as that by which actual separation is produced. This structure sufficiently accounts for the different combinations observable in the teeth of the peristome, not only in the different species, but even in the same species. As few, or indeed any, plates exist which give a correct representation of the peristomes of the *Splachna*, and as most descriptions are equally erroneous (or at least only partially correct), we subjoin the result of our own extended observations.

1. *S. ampullaceum*. In this species the teeth are, in some specimens, 16 unigeminated, and geminating in pairs: in others (and more usually) 8, equidistant, bigeminated.
2. *S. vasculosum* presents the same variation. HEDWIG'S figure of both species is incorrect. That of the present one, extremely so, except in the leaves.
3. *S. sphaericum*. This varies more than any other in the combinations of the teeth. There are in general 8, equidistant, either entire or slit down to the middle, and each of the divisions marked with a semipellucid line. Sometimes there are only 4, equidistant, each made up of 8 parts. In other specimens, again, there are 16 teeth, in the dry state, geminating in pairs, each with a longitudinal semipellucid line.
4. *S. Wormskioldii*. Peristome more regular; consisting, according to BROWN'S observations and our own, of 16 equidistant unigeminated teeth. The

original figure of this plant, in "Flora Danica," represents them as placed in pairs.

5. *S. tenue*. In very recent specimens there appear to be 8 equidistant, bigeminated teeth; but the process of drying (without pressure) produces a division into 16, geminating in pairs, each with a longitudinal line, denoting simple gemination; this line is somewhat obscure, from the thick substance, and consequent greater opacity, of the teeth. The figures in WEBER and MOHR, *Tasch*, t. 7. f. 2., and in "English Botany," t. 1133, are correct.
6. *S. octoblepharum*. From Dr HOOKER's figure and description in "Musci Exotici," there exists in this species the proper number of primary teeth. They are, however, permanently compounded into 8, each of which is marked by three longitudinal lines. Our own specimens have lost their peristomes; but from BROWN (in the Appendix to PARRY's first Voyage, p. ccc) placing it in the genus *Splachnum*, "dentibus reflexilibus," we are inclined to do the same, as that gentleman, the discoverer of the species, must have had more numerous opportunities of examination than any other. We suspect our friend Dr HOOKER has inadvertently transposed the words *siccitate* and *madore*, in describing the teeth; "siccitate (madore?) incurvis, madore (siccitate?) erectis vel etiam reflexis."
7. *S. Magellanicum*. Of this plant, BRIDEL says it possesses 16 geminate teeth; but from his remaining description, we suspect he intended 16 geminating, or, in other words, 8 geminated ones. We have ascertained that there are 16, resulting from the 8 teeth having divided: they are geminating in pairs, each tooth having a longitudinal line, which seems

to have escaped the penetrating eye of Mr BROWN. (PARRY'S First Voyage, Append.)

8. *S. mnioides*. In native specimens of this species we have had no difficulty in observing either 8 equidistant bigeminate teeth, or 16 unigeminate ones, geminating in pairs. In specimens which we regard as belonging to this species, brought from the Arctic regions by Captain PARRY, the teeth are extremely pellucid, and the line down each of the 16 teeth either very faint or invisible. None of the published figures of the peristomes are correct.
9. *S. urceolatum*. HEDWIG, and also STURM in "Deutschlands Flora," figure a peristome of 8 once geminated teeth. In "Flora Danica," t. 1361, there are represented 16 single equidistant teeth. We have found 8 equidistant, marked with 3 lines, at none of which have we observed any ultimate separation.
10. *S. angustatum*. BROWN, in PARRY'S Voyage (Appendix), has observed the peristome to consist of 4 bigeminate teeth. We have also seen it of 4 teeth, but in our specimens they are satisfactorily quadrigeminate. We find it, however, still more frequently of 16 unigeminated, the line more obscure than in many other species.
11. *S. luteum*. Teeth 16, unigeminated, and so closely geminating in pairs as often to appear like 8 equidistant bigeminated ones. The only good representation of the peristome is in SCHWÆGRICHEN'S figure of *S. melanocaulon* (Suppl. 2.), which we do not consider different.
12. *S. rubrum*. Peristome in every respect similar to the preceding.

From the above detail of facts and remarks, it appears,

1st, That every *Splachnum*, according to our view of the genus, has 32 primary teeth, placed in twos, in fours, or in eights, (or even sometimes irregularly). In this place we must notice the four additional species constituted by BROWN, in the Appendix to PARRY'S first Voyage, to all of which that profound botanist attributes 16 teeth for the primary number. We cannot confirm this, as we do not possess authenticated specimens of any of them; but conceive so remarkable an exception should be very cautiously admitted into physiological reasoning. That 16 teeth, however, were only visible in the peristomes examined by Mr BROWN, is a fact not to be questioned on his authority.

2dly, With the exception of *S. Wormskioldii*, whenever the teeth present the appearance of being 16 once geminated, they are also placed in pairs, though not equally so in every species, for we have observed them almost equidistant in specimens of *S. sphaericum*; and Mr BROWN also mentions, that, in *S. longicollum* of DICKSON (a plant of North America), the teeth are "vix manifeste per paria approximati." In *S. Wormskioldii* these teeth are equidistant, the main character, we apprehend, on which Mr BROWN has founded his genus *Aplodon*.

It should be recollected, however, that the 16 teeth of *S. Wormskioldii* are each composed of two united ones; or, in other words, they are geminate. We candidly confess, that those species which have 8 equidistant teeth, appear to us equally deserving of generic distinction, seeing that they are equidistant, though fewer in number, and composed of the same primary parts, each tooth being bigeminate. Taking, therefore, into consideration the great variety of combinations of these teeth, and the laws which the combinations seem to follow*, we have relinquished all

* The teeth are found to unite either in twos, in fours, or in eights. In *S. Wormskioldii* they are in twos.

hope of forming genera of the *Splachnoideæ* on characters thus derived.

From the remarks we have brought forward, it will be readily perceived that we can scarcely coincide with Mr BROWN in his views regarding *S. Wormskioldii*. At first sight it bears a strong resemblance to *S. sphaericum*, so strong, indeed, that the indifferent, though original and authentic, specimens we received of the "Flora Danica" plant, we were at first tempted to consider as a mere variety of that species. Those brought home by Captain PARRY proved them to be sufficiently distinct, the principal difference, however, seeming still to reside in the peristome. The fruit-stalk of *S. Wormskioldii* is certainly remarkably vasculose and succulent; but we have a very near approximation to the same structure in *S. sphaericum*, especially in that variety of it which has been called *gracile*. It is also seen in a somewhat less degree in *S. vasculosum*. In regard to the peristome, we have already shown that, in the moist state, there is no difference in the peristomes of any of the plants we have here brought together. When dry, it is true, the 16 geminated teeth of *S. Wormskioldii* are equidistant, though the other *Splachna* have them placed in pairs. Yet on this character Mr BROWN has observed, "Transitus ab *Aplodonte* ad *Splachnum* facilis est per *S. longicollum*, cui dentes vix manifeste per paria approximati, qua nota differt à *S. tenue* valde affine sed dentibus geminatis reflexilibus instructo." When such intermediate gradations exist, we submit, with the utmost deference, whether it be not desirable to keep together plants so intimately united by structure as well as habit.

There is one point of difference between *S. Wormskioldii* and other *Splachna*, which we have omitted to notice. The *columella* is nearly simple, or not nearly so capitate as in the rest. This, however, is a subordinate distinction, and

of less importance, when we consider that there is almost every gradation from the broad and tabular termination of this part in *S. rubrum* and *luteum*, to the simpler one in *S. Wormskioldii*. We have, however, even in this last, seen it dilated at the apex; but they were rare instances.

In our character of the genus we have described the theca as subcylindrical. This is true in a general point of view, but in particular instances liable to variation. Thus, in *S. tenue*, it is occasionally oblong, or even subglobose: in *S. Wormskioldii* often contracted both at its orifice and base, and in the arctic North American specimens so as to be almost globose. The *apophysis* assumes various appearances, though nearly constant in each individual species. Its colour is almost always green in the young state, and as constantly changes in maturity. In *S. vasculosum* its surface is singularly rugose or undulated, a character altogether omitted in HEDWIG'S figure (St. Crypt.), and even not sufficiently indicated in HOOKER'S superior representation (in Musc. Brit.) This remarkable feature we have observed in another plant we have found on Ben Lawers, of which the plate of *S. rugosum*, in "English Botany" (t. 2094.), is so faithful and characteristic, that we have no doubt whatever in referring it to that species.

In most species the apophysis is of a sufficiently rigid nature to retain its form to the last. *S. rubrum* and *luteum*, however, are possessed of one so large, and, at the same time, of so delicate and membranaceous a structure, that it speedily becomes collapsed, and the base of the apophysis is brought into contact with the base of the capsule.

The sporular sac in the *Splachna* (and probably in all other genera, as already mentioned under *Diphyscium*) is, in the young state, supported by a pillar formed, as it were, by an internal continuation of the fruit-stalk. This must, in *Splachna*, pass, of course, through the apophysis, and is

correctly enough represented by HEDWIG in his figure of *S. ampullaceum* (St. Crypt. v. 2. f. 14.)

The calyptra in all our British species is whitish: in *S. Wormskioldii* of a brownish hue. As far as we have seen, it is truly mitriform in its young state, and becomes dimidiate only by the enlargement of the capsule, when it is almost immediately deciduous. Our excellent correspondent, Professor HORNSCHUCH, is of the same opinion, and even observes, “mehrere Splachna haben eine calyptra campanulata multifissa die en die C. dimidiata ubergeht*.”

HAB. The *Splachna* are widely distributed throughout the alpine and the northern parts of Europe and North America. Species have been found also in the Straits of Magellan and in New Holland. Their places of growth are most remarkable, the greater number being found upon the dung of various animals. We ourselves have gathered *S. mnioides* attached to the long exposed bones of an ox. A friend of ours, who received the skull of a musk-ox, brought by Captain PARRY from Melville Island, discovered a luxuriant specimen of the same species (if we mistake not), lodged in the bones of the nose. Our esteemed friend Dr RICHARDSON mentions that he always found it in arctic America, enveloping with its roots the bones of some small animal †. But though most prefer some animal substance or other, there are exceptions; a few growing on the ground or in wet springy places, and one alone (*S. octoblepharum*) on the rotten trunks of trees.

HIST. The original *Splachnum*, or Σπλαγγνον, has been usually rendered in Latin by *viscus*, and it is no easy mat-

* HORNSCHUCH in Litt.

† RICHARDSON in FRANKLIN'S Journal, Append. p. 755.

ter to perceive how DIOSCORIDES* and GALEN † could have applied it to mosses. DILLENIIUS ‡, however, throws some light on this question, when he traces the plant of DIOSCORIDES to belong to the genus *Usnea*. Nevertheless, with all the want of connexion between it and the true mosses, we find that LAUR. MONTIN, in the second volume of the “*Amœnitates Academicæ*,” p. 248, bestowed the name upon the present genus, with the following character: “*Calyx calyptrata, operculata, receptaculo membranaceo, colorato, maximo, imposita.*” After which we have these remarks: “*Genericis itaque characteribus propositis, nomen antiquum, Splachnum, hinc adjungam, mutatum a DIOSCORIDE, qui Muscis hoc imposuit. Nomen genericum characterem essentialem exprimens in promptu quidem me habuisse non erit diffitendum; sed, ne mori a botanicis recepto contrarius viderer, suadente etiam Fund. Bot. § 241. vagum illud certo generi præfigere volui. Origo hujus nominis omnino est Græca, a voce Σπλαγγνον, abjecta litera γ, suos ducat natales.*” We regret, however, that MONTIN did not adopt another name.

The species observed to be natives of Great Britain before the time of DILLENIIUS, and represented by him, are, *S. ampullaceum*, *sphæricum*, and *mnioides*. A fourth, *S. rubrum*, from Lapland, is inserted in the Appendix. MONTIN, in the essay we have quoted, unites the three first, and adds *S. luteum* under the name of *flavum*. Since, then, other species have been described from time to time. HEDWIG, in his “*Stirpes Cryptogamæ*,” has three species, not known to LINNÆUS, *S. Frælichianum*, *urceolatum*, and

* DIOSC. I. I. c. 20.

† GALEN, των κατα τοπ. I. I. c. 1.

‡ DILL. Hist. Musc. p. 240.

Brewerianum, and in the "Species Muscorum," the additional ones of *S. ovatum* and *serratum*; several of the above, however, we consider as mere varieties. SCHWÆGRICHEN, in his first Supplement, enumerates in the whole fifteen species; of which, however, we regard *S. gracile* and *S. ovatum* as varieties of *S. sphaericum*, and *S. Brewerianum* as a variety of *S. mnioides*. In his second Supplement, he has described *S. melanocaulon*, which is, in our opinion, merely a dwarf variety of *S. luteum*. Sir J. E. SMITH has still another species, in "English Botany," *S. rugosum* of DICKSON. We are ignorant whether this be really DICKSON's plant or not. The authors of "Muscologia Britannica" state, that, from an examination of DICKSON's own specimens, they refer it to *S. sphaericum*. Be all this as it may, we have assuredly found the plant so well represented in "English Botany," and consider it specifically distinct from *S. vasculosum*, to which it is nearly allied. DICKSON, who is the original authority for many species taken up by HEDWIG and SMITH, has described another species, about which much doubt has arisen: this is *S. longicollum*, a plant which has been referred by Doctors HOOKER and TAYLOR to *S. tenue*. BROWN, on the other hand, says that it has never been found in this country, "Americæ occidentali nec Scotiæ indigenum *," and that it is different from *S. tenue*.

We have now a few recent works to notice. Out of the seven species contained in the "Muscologia Britannica," we have referred *S. Frælichianum* to the next genus (*Dissodon nobis*). In HOOKER's "Musci Exotici" are two species, *S. octoblepharum* and *S. scabrisetum*, the latter of which we also refer to *Dissodon*. HORNSCHUCH, in the

* PARRY's first Voyage, Append. p. cccxcix.

“*Horæ Physicæ Berolenses,*” has figured the beautiful *S. Adamsonianum*, of which we have no authentic specimens. A plant has been recently communicated to us by Dr HOOKER, brought home by Captain PARRY in his second Expedition, and which is no way different from the Kamtschatka one: Dr HOOKER at the same time mentioned that he considered this identical with the *S. paradoxum* of BROWN. It appears a good species, intermediate between *S. tenue* and *mnioides*. We can scarcely presume to judge of *S. arcticum*, *propinquum*, and *exsertum*, of BROWN, in the Appendix to PARRY’s first Voyage, as we have not specimens; but we cannot resist the suggestion that they may be different states of that polymorphous species *S. mnioides*,—nor do we even venture thus far, without having examined very many varieties of what we consider *S. mnioides*, presented to us by Mr EDWARDS, and other gentlemen who accompanied Captain PARRY on his *second* voyage.

After subtracting from the twenty-two species, described by BRIDEL, those which are mere varieties, and some species belonging to other genera, and adding to the remainder, *S. octoblepharum* (HOOK.), *S. Wormskioldii* (HORNEB.), *S. longicollum* (DICKS.), and *S. Adamsonianum* (HORNSCH.), we shall count sixteen well-established species*.

* Of those we reject, *S. Wulfenianum* is *Orthotrichum Ludwigii* (SCHWÆGR.)—*S. Frælichianum* we place under *Dissodon* (excluding, of course, *Gymnostomum Griffithianum*, confounded with it by BRIDEL and SWARTZ).—*S. lingulatum* is our *Dissodon splachnoides*.—*S. serratum* and *flagellare* are varieties of *S. tenue*.—*S. Brewerianum*, a variety of *S. mnioides*.—*S. setaceum*, certainly only a variety of *S. angustatum*.—*S. ovatum* and *gracile*, varieties of *S. sphaericum*.—*S. pusillum*, according to PALLISOT’s Herbarium, is *S. vasculosum*.—*S. Turnerianum* does not differ from *S. ampullaceum*.—As to *S. Juressi*, we have not seen it, and know not what to make of it.



SPLACHNUM DISSODON TAYLORIA

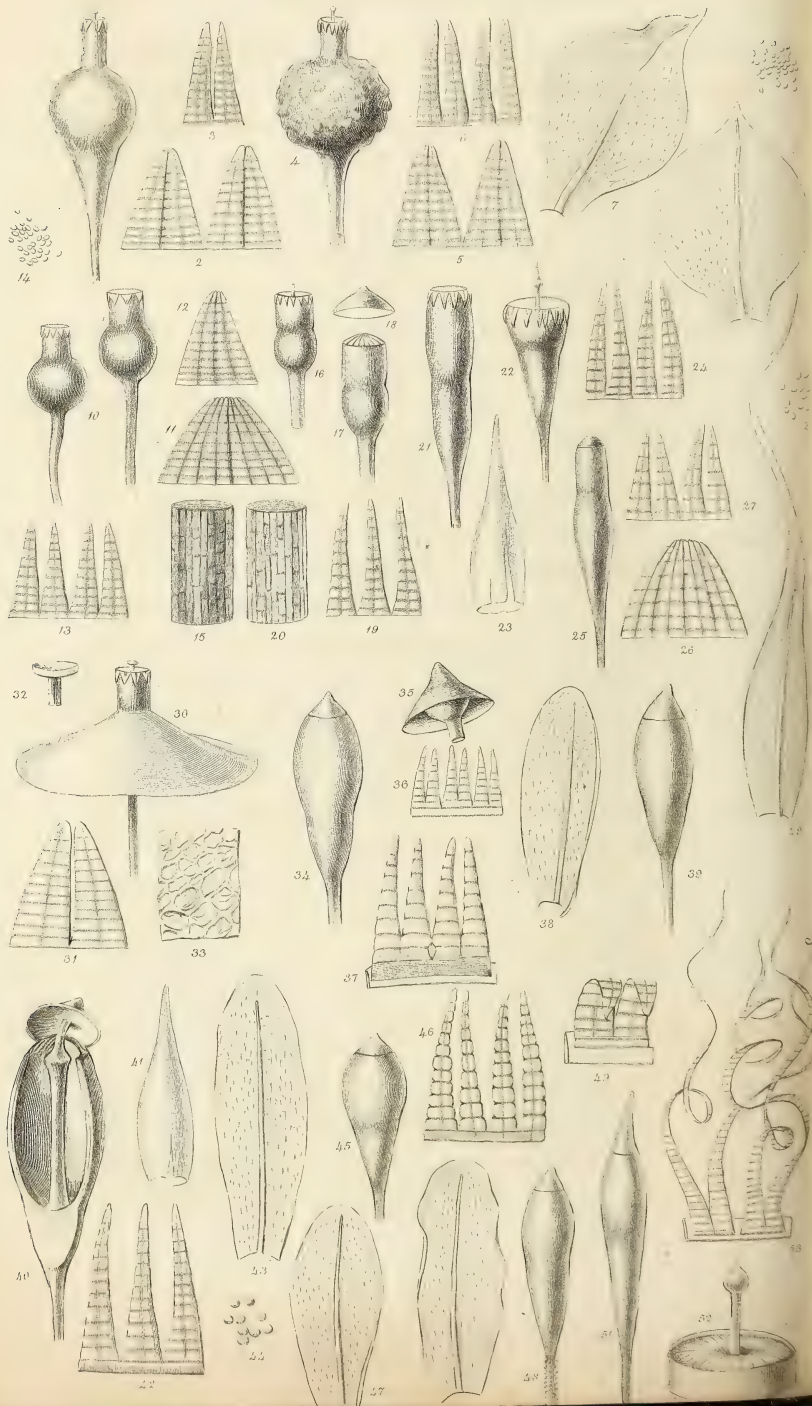

PLATE XIII.

- Fig. 1. Theca of *Splachnum ampullaceum*. 2. The teeth, when 8, bigeminate. 3. Do., when 16, unigeminate.
4. Theca of *S. vasculosum*. 5. The teeth when bigeminate. 6. Do. when 16, unigeminate.
7. Upper leaf of *S. rugosum* (Eng. Bot.) 8. Lower do. 9. Sporules.
10. Thecæ of *S. sphaericum*. 11. One of the teeth when quadrigeminate. 12. One do. when bigeminate. 13. Teeth when 16, unigeminate. 14. Sporules. 15. Appearance of the fruit-stalk when highly magnified.
16. A dry theca of *S. Wormskioldii*. 17. A moist one. 18. The operculum. 19. The teeth. 20. The fruit-stalk highly magnified.
21. Theca of *S. tenue*. 22. Theca of do. in the dry state. 23. Calyptra of do. 24. Teeth when 16, unigeminate.
25. Theca, with the operculum, of *S. angustatum*. 26. One of the teeth when quadrigeminate. 27. Teeth when 16, unigeminate. 28. Sporules, which are larger than in the other species, and of a yellow colour. 29. Leaf.
30. Theca of *S. luteum*. 31. Teeth. 32. Summit of columella. 33. Structure of the apophysis highly magnified.

 GEN. XII. DISSODON *nobis*.

FRUCT. *Calyptra* primo mitriformis, mox sæpius dimidiata, albida, scariosa, tenera, lævis, glabra, basi integra,

valde fugax. *Seta* terminalis, plerumque lævis (in una tamen scabra), rigida, sæpius breviuscula, stricta, quandoque elongata et subflexuosa, e luteo rubescens. *Apophysis* matura, obconica, thecæ paullo angustior et concolor, lævis. *Theca* integra, ovata, apophysi longitudine subæqualis, lævis, ore paullum contracto, absque annulo elastico. *Operculum* thecæ subconcolor, breve conicum, obtusum, in quibusdam speciebus interne columella adnatum et diu persistens. *Peristomium* simplex, e dentibus primarius 32, unigeminantibus, siccitate strictis, plus minusve erectis, nunquam reflexis constans: dentes geminati siccitate vel equidistantes vel per paria geminantes at madore ut in *Splachno*. *Columella* plus minusve exserta, stricta, rigida, apice dilatato-globosa. *Sporulæ* ut in *Splachno*.

CHAR. DIFF. *Seta terminalis*. *Theca apophysata*. *Peristomium simplex e dentibus geminantibus, siccitate erectis, strictis*. *Columella apice dilatata*. *Calyptra lævis, basi integra, fugax*.

FRUCT. *Calyptra* at first mitriform, at length mostly dimidiate, whitish, scariose, tender, even, glabrous, very fugacious. *Fruit-stalk* terminal, mostly even (in one species rough), rigid, generally rather short, straight, sometimes elongated, and subflexuose, yellowish or reddish. *Apophysis* when mature obconical, a little narrower than the theca, nearly the same colour, and smooth. *Theca* entire, ovate, about equal in length to the apophysis, even, slightly contracted at the mouth, and without an elastic ring. *Lid* nearly of the same colour as the capsule, shortly conical, obtuse; in some species, internally adnate with the columella, and remaining a considerable time. *Peristome* simple, of 32 primary, once geminating teeth; which, when dry, are straight, more or less erect, never reflexed: these

geminated teeth, when dry, are either equidistant, or geminating in pairs; when moist, they are the same as in *Splachnum*. *Columella* more or less exerted, straight, rigid, dilated in a globose manner at the summit. *Sporules* as in *Splachnum*.

DIFF. CHAR. *Fruit-stalk terminal. Capsule with an apophysis. Peristome simple, of geminating teeth, which when dry are erect and straight. Calumella dilated at the apex. Calyptra even, entire at the base, fugacious.*

VEG. *Stems* forming dense tufts, erect, more or less elongated, nearly simple: (in our *D. Splachnoides* they often occur 2—3 inches in length, deeply imbedded in the ground). *Leaves* imbricated pretty closely on all sides of the stem, suberect or patent, especially towards the summit of the stem. They are all highly vasculose and reticulated, green when growing, but sometimes gaining a yellowish hue in drying. They are nearly uniform in shape, between ovate and lingulate, all remarkably rounded and obtuse at the extremity, and concave. There is no appearance of serratures, and the nerve in every instance disappears a little below the summit. The perichæatial leaves do not differ from the rest, except in being perhaps more patent.

Obs. For the institution of this genus, as well as the alterations of the preceding one, we solicit the indulgence of muscologists,—at least till what we have advanced has been submitted to a fair examination. It may be urged against us that we rest too strongly upon the appearance of the peristome in a dry state. We do believe that, in this genus, the main generic distinctions are to be taken from the characters then exhibited. We have shown that, when moist, nearly all the peristomes of the *Splachnoideæ* have

a wonderful resemblance to each other; that, in short, no generic marks can then be collected from them.

When, on the other hand, we note the *direction* of the teeth in a dry state, and find that they constitute more obvious distinctive features;—that all those species which have reflexed teeth form a natural group, even to the acute form of the leaves (except in *S. vasculosum* alone);—that all those which have erect teeth* (not reflexed) agree still more beautifully in habit, their capsule of a different shape, their apophysis narrower than the capsule, and of the same colour, their leaves all agreeing most strikingly in their obtuse form and texture;—that, farther, when we see equally forcible characters taken from the direction of the teeth in the dry state of *Tayloria*, we cannot help flattering ourselves, that, for the tribe of mosses now under consideration, these are the only tangible generic characters. Those we have discarded seem only of importance, inasmuch as they indicate affinity and similarity of structure.

The peristome of *Dissodon* varies much in the same manner as that of *Splachnum*: 1st, In one species, the teeth are 16, once geminated, and equidistant; besides which, each tooth, when mature, is divided at the line of gemination, either to the middle or to the base. 2dly, In another species, the teeth, though 16, and also equidistant, remain permanently once geminated. 3dly, In the other species, they are 16 once geminated, and also geminating in pairs†.

* MR BROWN seems to consider erect teeth as worthy to constitute a subgeneric character, and thinks *S. Frælichianum* and *S. Wulfenianum* might be placed together on that account, joined to the inclined capsule.—PARRY'S First Voy. App. p. ccci.

† We have in our possession, through the kindness of our friend Dr HOOKER, a plant which we consider to belong to this genus: but as it has only a manuscript name attached to it, we refrain from noticing it farther. It assimilates with the rest in every character.

Of the first mentioned of these we have the genus *Systylium* of HORNSCHUCH, on account of the teeth being rather short, erect, geminating in pairs, and the lid connate with the columella. Of the second, we have the genus *Cyrtodon* of BROWN, on account of the teeth being long and incurved at the apex. Of one of the last, Mr BROWN observes, “*Splachnum Frælichianum* et forsan *S. Wulfenianum* *, capsula inclinata et dentibus erectis a Splachnis genuinis distinguitur, et subgenus efformat.” Under *Aplodon*, the same author shows, nevertheless, how near his *Cyrtodon* is allied to *S. Frælichianum*: “*Diversa præsertim dentibus erectis apicibus incurvis, ideoque S. Frælichiano dentibus erectis, sed geminatis affinis.*” Upon these principles, we fear, genera might be constituted of several more species of *Splachnum*; for instance, *Dissodon scabrisetum* (*Splachnum scabrisetum*, HOOK.) has the teeth involute in a remarkable degree, when moist †, and in this circumstance differing from all the rest; this is, we apprehend, as valid a generic character as some of the above,—but, at the same time, of as little consequence.

Of all the plants we have brought together under this genus, *Systylium* seems, at first sight, to have the greatest claims to be kept apart, and that, on account of the long persistent lid. We agree with BROWN, however, that this can scarcely form a generic character. Under *Aplodon*, he observes, “*In hoc enim cohærentia operculi cum columella ex analogia cum Gymnostomis quibusdam, pro caractere specifici tantum valoris habenda sit.*” Besides, the lid eventually separates from the columella: but a stronger reason

* This plant is *Orthotrichum* Ludwigii.

† We do not mean to say that the teeth were involute before the operculum dropt off, but only after having been exposed to the action of the atmosphere.

still against its being retained as a generic character, is, that a similar circumstance exists, in a less degree, in recent specimens of *Dissodon Splachnoides* (*Weissia Splachnoides*, Auct.) The lid is here very frequently adnate with the columella for a considerable time, and is so represented both by Dr HOOKER in "Fl. Lond." and Dr GREVILLE in "Crypt. Fl.:" it is therefore at least exactly intermediate, in this respect, between HORNSCHUCH's *Systilium* and the rest of our *Dissodontes*.

Two very remarkable points, common to all our species, are, the ovate form of the theca, and the obconical apophysis: the latter tapering downwards from the base of the capsule, renders the shape of the whole more or less obovate, and affords a fructification very different, at first sight, from that of *Splachnum*; more especially when we take into consideration the equally remarkable fact, that, in *Splachnum*, the apophysis is coloured, whereas, in *Dissodon*, it is of the same colour as the capsule. Thus, not only in habit, but in every character of importance, do all the species of the latter genus agree.

HAB. We are not aware that any of the species are produced on any decomposing substances, as are most of the last genus. One is found among rocks; another in a firm, wet sward, intermixed with grass and other plants; a third in the crevices of rocks. As to the fourth, we do not certainly know on what it was found growing. Three are peculiar to the alpine parts of Europe. The other occurs in South America.

HIST. We have already mentioned that one of our species had previously constituted a genus under the name of *Systilium*, and that of another was formed *Cyrtodon*. As these names imply a peculiarity of structure not common

to all the plants we have brought together, we have been obliged to reject both, although, from respect to Mr BROWN, and friendship for our correspondent Dr HORNSCHUCH, we would gladly have avoided it, if possible. Had not the name *Orthodon* been preoccupied, it would have been precisely that we should have taken for the present genus; which we have denominated *Dissodon*, a word at least expressing a character common to all the species. The first known of our species was described and figured by HEDWIG, and about the same time discovered in this country by DICKSON on the Scottish alps. DICKSON seems to have discovered the next, and published it as a *Splachnum*; but SWARTZ, almost immediately following, described it as a *Weissia*, the generic name of which it has retained ever since, till BROWN gave it that of *Cyrtodon*. Of this plant, we may here remark, that, from the imperfection of the specimens existing in herbaria, no correct figure had been given till the year 1824, when both Dr HOOKER and Dr GREVILLE published ample analyses of the different parts. The geminated structure of each tooth was observed some years ago by Mr ARNOTT, in specimens procured from the Reverend Mr MACRITCHIE of Clunie, and urged with several muscologists as a proof how incorrectly it had been allowed to remain in the genus *Weissia*. Mr BROWN, however, has the first claim for the publication of this structure. To Dr HORNSCHUCH we freely expressed our opinion that his *Systylium* could not be separated as a genus from the same plant. Along with additional specimens for examination, he obliged us, in return, with the following remarks: —“ Ich nicht glaube dass es mit *Weissia Splachnoides* in ein genus vereinigt werden kann, da der Bau der Taehne gar zu bedeutentend abweicht, wie Ihnen die Untersuchung zeigen wird, auch ist die Verwachsung des operculi mit der Columella so standhaft und ausgezeichnet dass sie nach

meinen dafürhalten immer als Merkmaal bey Aufstellung des Gattungsscharacters mit zu Hülfe genommen werden kann." We have examined the specimens he kindly sent to us, and regret to say we still cannot coincide with him on the importance of the characters which he draws from the peristome and columella, above alluded to. As we have united several genera in the formation of *Dissodon*, we conceive that characters of the species may not be unacceptable.

1. *Dissodon Splachnoides*; foliis patentibus, lingulatis, obtusis, concavis; peristomii dentibus 16 geminatis, integris, æquidistantibus apice incurvis; seta lævi.

Weissia *splachnoides*, Swartz. Schwægr. Suppl. 1. p. 63. t. 17.—

Hook. et Tayl. Musc. Brit. t. 14. Fl. Lond. (New Series) t. 192.

—Grev. Crypt. Fl. t. 145.—Funck Deutschl. Moose. t. 9.

Splachnum lingulatum, Dicks. Cr. fasc. 4. p. 4. t. 10. f. 6.—Smith, Engl. Bot. t. 2095.—Brid. Meth. p. 105.

Grimmia splachnoides, Smith, Engl. Bot. t. 2164. (excl. fig. fol., et synon. Dicks. ac Fl. Brit.)

Cyrtodon, Brown in Parry's First Voyage, Append. p. cxcix.

HAB. Scotland, Germany, Lapland, etc.: in turf-bogs at a considerable elevation.

The 16 geminated teeth are of a yellow colour. The columella is often much exerted, and the lid frequently adnate with its apex.

2. *D. Hornschuchii*, foliis erectis, appressis, ovato-lingulatis, obtusis, concavis; peristomii dentibus 16 geminatis, per lineam separabilem solventibus, æquidistantibus, rectis: seta lævi.

Stylyium splachnoides, Hornsch. in Comment. de Voit. et Syst. p.

14. t. 2.—Hook. Musc. Exot. t. 98.—Schwægr. Suppl. 2. t. 107.

Funck, Deutschl. Moose. t. 6.

HAB. On a micaceous rock in the Carinthian Alps.

The teeth are short, and bright red, and usually so deeply divided at the line of gemination as almost to present the

appearance of 32 teeth placed in pairs. The last species has the seta elongated: in the present one it is short and thick.

3. *D. Frælichianum*, foliis erectis, appressis, ovato-lingulatis, obtusis, concavis; peristomii dentibus 16 geminatis et per paria geminantibus.

Splachnum Frælichianum, Hedw. Stirps. Crypt. 3. p. 99. t. 40.—Schwægr. Suppl. 1. pt. 1, p. 51.—Brid. Meth. p. 105.—Schkukr, t. 18.—Sturm, Deutschl. Fl. fasc. 15.—Funck Deutschl. Moose. t. 7.

Splachnum reticulatum, Swartz. Smith Engl. Bot. t. 2507. (quoad folia mala).

Bryum reticulatum, Dicks. Cr. fasc. 2. p. 4. t. 4. f. 6.

HAB. Fissures of rocks in Switzerland, Germany, Scotland, and Sweden.

Many foreign botanists have, till lately, confounded this with *Gymnostomum Griffithianum*; a mistake which originated from the latter not having been seen by them.

4. *D. scabrisetum*, foliis subpatentibus, lingulatis, obtusis, subconcavis, dentibus 16 geminatis et per paria geminantibus, madore involutis; seta scabra.

Splachnum scabrisetum, Hook. Musc. Exot. t. 32.

HAB. Province of Jaen de Bracomoros, South America, at an altitude of about 6400 feet.

This species has the teeth erect when dry, at least in our specimens, received from HUMBOLDT and KUNTH. When moist, they are remarkably involute. The leaves are less concave than in the rest, and slightly undulated.

PLATE XIII.

Fig. 34. Capsule of *Dissodon Hornschuchii*, with the operculum. 35. Operculum, with a portion of the adnate columella. 36. Portion of the peristome. 37. Two of the geminate divided teeth, all united at the base. 38. Leaf.

39. Capsule of *D. splachnoides*, with the operculum.
 40. The same dissected, and showing the columella adnate with the operculum. 41. Calyptra.
 42. Three of the 16 geminate teeth, all united at the base. 43. Leaf. 44. Sporules.
 45. Capsule of *D. Frælichianum*, with the operculum.
 46. Four of the 16 geminate teeth, all united at the base. 47. Leaf.
 48. Capsule of *D. scabrisetum*, with the operculum.
 49. Two of the involute (when moist) geminate teeth united at the base. 50. Leaf.

GEN. XIII. TAYLORIA, *Hooker*.

FRUCT. *Calyptra* mitriformis, albida, scariosa, tenera, lævis, glabra, valde fugax. *Seta* terminalis, elongata, lævis, rigida, strictiuscula, aurantiaca. *Apophysis* matura obconica, theca longior et angustior, subconcolor, lævis. *Theca* integra, oblongo-cylindrica, lævis, pallide brunnea, ore rubescente. *Operculum* conico-elongatum, obtusum, theca subæqualis, paullo incurvum, concolor. *Peristomium* simplex e dentibus 32 unigeminantibus, infra marginem thecæ intus insertis, longissimis, attenuatis, rubris, transversim striatis; madore intra thecam involutis, siccitate, "erecti diffusi, halitu observantis tacti singuli spiraliter, sed laxè se contorquentes et rursus evolventes, semina dispergentes, continuo tremuli et mobiles, simili quodam motu ut fila, Equiseti germen cingentia," (SCHWÆGR.) *Columella* valde exserta, stricta, rigida, globoso-capitata. *Sporula*

CHAR. DIFF. *Seta* terminalis. *Theca* apophysata. *Peristomium* simplex, e dentibus 32 geminantibus, longissi-

mis, siccitate diffusis, tortuosis. Columella apice globoso-capitata. Calyptra lævis, fugax.

FRUCT. *Calyptra* mitriform, white, scariose, tender, even, smooth, very fugacious. *Fruit-stalk* terminal, elongated, even, rigid, straight, of a reddish-orange colour. *Apophysis*, when mature, obconical, longer and narrower than the capsule, nearly of the same colour, even. *Theca* entire, oblong-cylindrical, even, pale brown, the mouth reddish. *Lid* conical, elongated, obtuse, nearly equal in length to the theca, and of the same colour, somewhat curved. *Peristome* simple, of 32 unigeminating teeth, very long, attenuated, transversely striated, inserted a little below the inner margin of the orifice: when moist they are highly involute, and concealed within the capsule: when dry, erect, diffuse, spirally twisting together in a lax manner under the influence of the moist breath or touch, and again becoming evolved, scattering the sporules, and preserving a constant tremulous motion, similar to that of the filaments which embrace the germen of the *Equiseti*. *Columella* much exerted, straight, rigid, globoso-capitate. *Sporules*

DIFF. CHAR. *Fruit-stalk* terminal. *Capsule* with an *apophysis*. *Peristome* simple, of 32 very long geminating teeth, which when dry are diffuse and tortuose. *Columella* globoso-capitate. *Calyptra* even, fugacious.

VEG. Stems for the most part tufted, about an inch long, either simple, or branched with innovations, the lower parts covered with a ferruginous down. The lower leaves are smaller than the upper ones; the latter more closely arranged; they are all imbricated, green, erecto-patent, ovato-lanceolate, acute, with a serrated margin towards the

apex: their substance is tender, pellucid, loosely reticulated, as in the *Splachna*. The nerve disappears beneath the summit. The perichæatial leaves are four or five in number, and are considerably smaller than the cauline ones.

Obs. No plant that has come under our observation has so great a resemblance to this species as *Splachnum tenue*: the likeness is indeed so strong, that, to the naked eye, there is no difference, except in the lid, which, if it be wanting, leaves the microscope alone to determine between the two. With the assistance of that instrument there is no difficulty, if the peristome be present.

Dr HOOKER has figured this moss more correctly than any one else, and represented the approximation, or rather gemination, of the teeth with more truth than SCHWÆGRICHEN. They are of a very fine red, most remarkably long, longer even than the theca itself; in the dry state they become reflexed, and tortuous in an extraordinary degree, contracting and expanding themselves with great rapidity on the application of the slightest degree of moisture or warmth. The fruit-stalk varies from one to two inches in length, and is smooth, solitary, erect, or slightly flexuose. The theca, when growing, is almost cylindrical, but in the process of drying often becomes nearly hemispherical*. The apophysis tapers so gradually downwards from the theca, that, being of the same colour, it seems at first sight a continuation of that part.

HAB. On wet rocks in Norway, Switzerland, the southern Tyrolese Alps, and the summits of the Carinthian mountains.

* This also takes place not unfrequently in *Splachnum tenue*.

HIST. Under this head we have little to say, there being only one species in the genus, and that one recently introduced to the notice of muscologists. We believe it to have been discovered by the lamented Professor SCHMIDT of Christiana, the same who accompanied Captain TUCKEY in his expedition to the Congo river. We know not if he bestowed on it a name. In 1814, Dr HOOKER found it on the *Grimsel*, close to the Glacier du Rhone, at an altitude of about 5000 feet; and he soon after constituted the present genus, in order to receive it, in BRANDE'S Journal of Science and the Arts*. In the mean time, SCHLEICHER and SERINGE also gathered it in Switzerland, and transmitted specimens to SCHWÆGRICHEN, under the manuscript name of *Hookeria*. Thus while HOOKER dedicated it to his friend, and future coadjutor in the *Muscologia Britannica*, it was named on the Continent after himself;—a singular and interesting coincidence. It so happened that both names were made public in the same year (1816). *Tayloria*, however, had the precedence of some months; yet it is a strange circumstance that, till recently, it has been discarded by every continental botanist, and *Hookeria* substituted in its place, although that name was preoccupied by Sir J. E. SMITH, in favour of another genus, also of mosses. We rejoice to find at length the justice of the claim of *Tayloria* acknowledged. Our friends NEES VON ESENBECK and HORNSCHUCH have taken up both it and *Hookeria* of SMITH in their excellent "*Bryologia Germanica*;" and we are acquainted with no muscologists possessed of more liberal feelings, or who are so well able to establish both genera as firmly on the Continent, as they have long been in this country. SPRENGEL has also adopted

* No. 3. p. 146.

*Hookeria**. It must be confessed, that, when our friend Professor SCHWÆGRICHEN thus expressed his opinion concerning SMITH's *Hookeria*, "Quam proposuit SMITHIUS in Actis Societatis Linnæanæ, v. 9. p. 272, *Hookeria* in systemate Hedwigiano genus proprium esse nequit," he should at least have left the field open, and the name otherwise unappropriated;—Sir J. E. SMITH being besides a warm supporter, and no less an able one of the Hedwigian school.

PLATE XIII.

- Fig. 51. Capsule of *Tayloria*, with the operculum.
 52. Summit of the capsule, shewing the exerted columella, and the teeth in the involute state, within the capsule. 53. Four of the 32 geminating teeth, as appearing in the dry state, when they are spreading from the orifice in all directions.

* "Neue Entdeckungen," vol. 3.

XXVII.—*Notice in regard to the Trap Rocks in the Mountain Districts of the West and North-west of the Counties of York, Durham, Westmoreland, Cumberland, and Northumberland.*

By HENRY WITHAM, Esq. of Lartington.

(*Read 3d May 1824.*)

THE various opinions which have been entertained at different periods respecting the origin of the Trap Formation, by the most distinguished geologists, gives a peculiar interest to its geognostical history, and confers on those districts where it occurs a high degree of importance. Some geologists, as is well known, maintain, that secondary trap rocks owe their origin to the action of subterranean heat; which power, it is alleged, was instrumental in giving them their mineralogical characters, and present position in the crust of the Earth. This immeasurable power, according to the igneous theory, forced them from their birthplace, very deep in the bowels of the earth—even under gneiss and mica-slate, through every variety of primitive and transition rock, to their present place in the formations of the secondary class. These secondary traps, then, if this explanation

is the true one, are placed deeper in the crust of the Earth than gneiss and other primitive rocks. But this Huttonian explanation is opposed, and with much ingenuity and force of argument, and detail of fact, by the Neptunians, who insist on the deposition of trap from aqueous solution and suspension. We do not pretend to advocate either opinion, but maintain, that these rival hypotheses have been eminently useful, and that, without their aid, geology would have long remained stationary. Can we believe those to be in earnest who assert, that opinions, which have been the means of calling into action the zeal and acuteness of such observers as HALL, JAMESON, and BUCKLAND, and which have afforded opportunities for splendid displays of the powers of HUTTON, WERNER, PLAYFAIR, and CUVIER, have been not only useless, but even pernicious?

On visiting the districts enumerated above, my attention was forcibly arrested by the phenomena exhibited by the trap-rocks, and it is of these I now propose to lay a notice before the Society. But as these are considered by geologists as forming part of the same general series with those of Derbyshire, we shall first mention shortly the Derbyshire stratification.

In the metalliferous strata of Derbyshire, it appears there are nine different alternations; namely, grit-rock 120 yards, limestone-shale 160 yards, first limestone-rock 50 yards, first toadstone or amygdaloid 20 yards, second limestone-rock 50 yards, second toadstone or amygdaloid 30 yards, fourth limestone-rock 130 yards; making a total thickness of 650 yards. Here we perceive the beds of metalliferous limestone are separated by beds of trap rocks, called Toadstone. When a vein of lead is worked through the first limestone down to the toadstone, it ceases to contain ore, and often entirely disappears. On sinking through the toadstone to the second limestone, the ore is again found, but cut off by a lower

bed of toadstone, under which it again appears in the third limestone. In a few instances strings and short branches of ore have been discovered, but the few veins which pass through this substance contain no ore. How to account for this unequalled stratified arrangement must require no small share of ingenuity. It has been maintained, that the toadstone and limestone, with the metallic veins of this district, are of contemporaneous formation, but the different organic remains in the upper and lower beds of limestone preclude the possibility of such simultaneous formation. CUVIER has very justly observed, that the existence of different organic remains, offers irresistible proof, that the upper and lower strata in which they were found, were formed in succession. The rapid progress of the science of chemistry, will, it is to be hoped, ere long, dispel the darkness, and furnish a solution to this hitherto unexplained phenomenon.

The great trap mass of Teesdale shews itself on the south bank of that river, just opposite to Middleton, in Teesdale, and extends to a great breadth to the Chain-bridge, where it forms the bed of the river, which has worn a deep chasm through it. At the Highforce (a waterfall of 70 feet perpendicular) the river has worn its bed completely through it, and shews it resting on the encrinite limestone, and dipping regularly to the NE. at an angle of not more than 12° with the horizon. Here may be distinctly seen, on the right side of the waterfall, the great Marbeck vein, intersecting both the trap and the limestone. This fact is interesting, as to the relative age of this trap, shewing it must have been in existence previous to the formation of the veins which pass uninterruptedly from the other strata through it. I am informed by miners this is always the case, and that they very frequently bear ore. At Maisebeck, in Tyne Bottom, there is a rib of

solid ore of four inches, which intersects the trap. The specimens I have now the honour of laying before the Society, are from a vein which runs east and west in the basalt, which extends over this district immediately at the foot of Crossfell, and is at present working at the point where Troutbeck, coming from the south-west, joins the river Tees. The vein from which I obtained these specimens is supposed to be a prolongation of one at present working in Harwood. If this could be ascertained, I think it might lead to some very interesting speculations on the subject. My friend Mr JOBLING of Newtonhall, to whose kindness I am indebted for much useful information, is not aware there are at present any veins raising ore in this district, but there are many old workings in the basalt.

The trap rises to a considerable elevation, and in prodigious masses, from the Highforce to the south of Croakley and Croakley Fell, and at Cauldron Snout, about six miles NW. from the Highforce, where it again interrupts the progress of the Tees, and gives rise to a succession of beautiful cascades, to the height of 200 feet. Here it rests on the same limestone, and is covered to the NE. by a white and highly crystalline quartz-rock, which is intersected in every direction by bearing lead-veins, which the miners say penetrate the trap, but, owing to the hardness of the substance, has not been profitable to work. The colour of the trap (of which you have here a specimen) is bluish-grey, a mixture of augite and white felspar in small crystals. It is extremely hard and tough, and the fracture inclined to conchoidal. It sometimes inclines to the columnar form, particularly at the Highforce, and other interesting sections in the neighbourhood. The dip of the trap corresponds with that of the other strata NE. The most intelligent miners are of opinion that this rock may be traced for above thirty miles to

the south of the above described boundaries. They consider it as perfectly stratified, and estimate its depth from 12 to 18 fathoms. The extent of this field of trap is of prodigious magnitude. Its length from N. to S. must exceed 70 miles, and in many situations its breadth is from 12 to 15 miles.

From what source this great trap-range is to be traced, is a subject upon which the most highly enlightened geologists, mineralogists, and chemists, are as yet at variance. By some it is believed that this immense mass of greenstone has been poured out from that singularly extensive and curious whin-dike (commonly called the Bolam, or Yorkshire Dike), which may be seen marked in all the geological maps. It may be distinctly traced from the German Ocean, near Whitby, a distance of above 70 miles, into the field under consideration. By others, it is contended, that it is the production of a vast volcanic eruption from the alpine chain at its head. To others, again, there appear strong reasons to suspect either of these possibilities: *1st*, The source from which it is supposed to flow, is not known to contain any metallic ores; *2dly*, The substance in this great extent appears to have no tendency to vesicular concretions, or any vitreous appearance; and, *3dly*, Its regular stratification for so great a distance, induces belief, that its formation has been in contemporaneous succession with the various strata forming the successive and curious alternations in this interesting district of the lead-measures.

The vast extent of this mass of trap or greenstone, its *stratification*, its veins of galena, its relations with the neighbouring strata, render it highly deserving of the attention of the geologist and the miner.

The present notice, although very imperfect, will, I trust, lead to a farther examination of the trap-rocks of

the north of England, and also to a comparison of the phenomena of their various junctions, alternations, and intermixtures with those exhibited in other parts of England and particularly in Scotland, a country eminently distinguished for the varied and highly interesting displays of the formations of the trap-rocks.



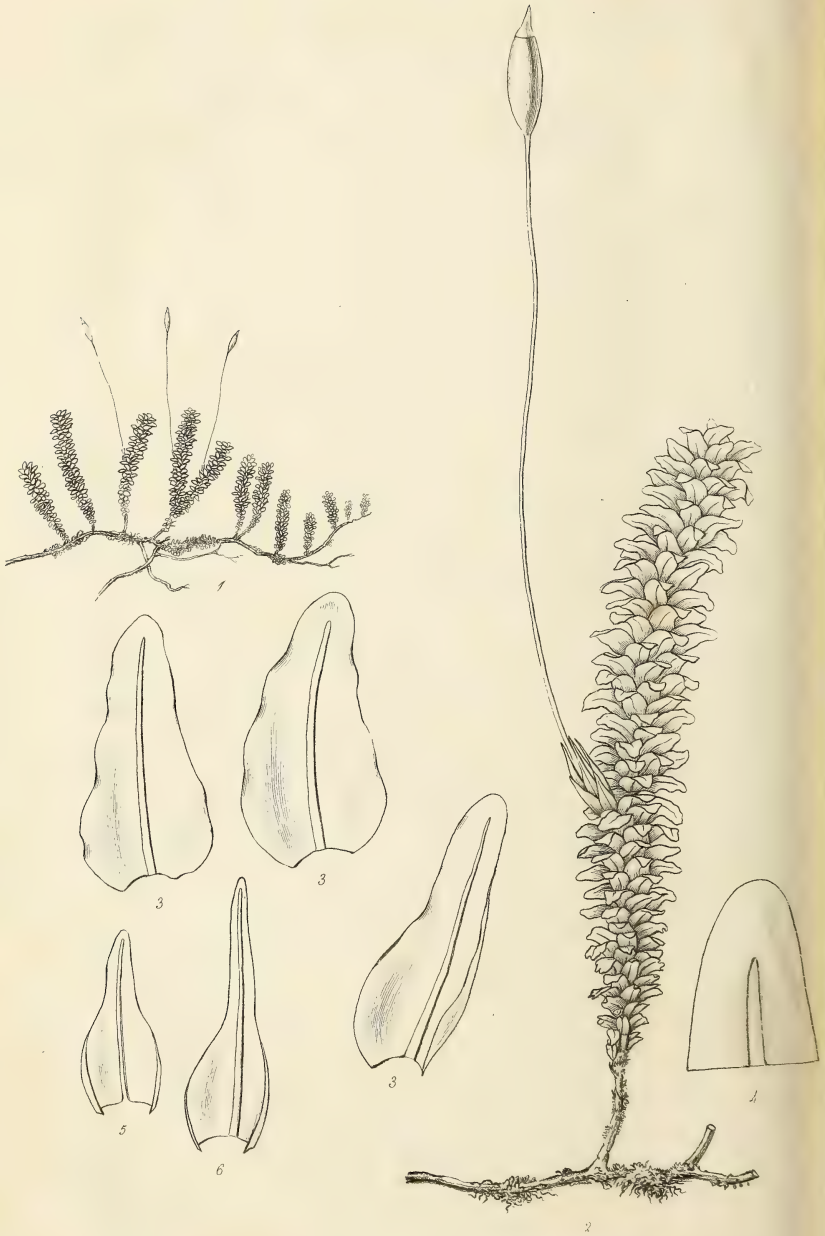

Vespa Americana

XXVIII.—*Descriptions of Two New Species of Musci, belonging to the Genera Neckera and Hypnum.*

By ROBERT KAYE GREVILLE, LL.D. F.R.S.E. &c.

(Read 30th April 1825.)

NECKERA AMERICANA, *Grev.*

N. Americana; caulibus repentibus, ramis erectis; foliis patentibus, integris, ovato-oblongis, apicibus rotundatis, nervo apicem versus evanescenti; theca oblonga, erecta, seta elongata. Tab. XIV.

HAB. Trunks of trees (and on rocks?) in the United States. D. B. Greene, Esq.

Stems creeping, much entangled, throwing up numerous, erect, nearly simple branches about an inch or more in height. *Leaves* very numerous and closely set, spreading horizontally, ovate-oblong, or, sometimes, almost cordate-ovate, somewhat undulate, entire at the margin, much rounded at the extremity, the nerve strong, and disappearing at some distance from the summit. *Substance* very soft, thick, dense, and injured by the slightest touch in dissecting. *Colour* rather pale, of an opaque and pleasant green, brownish on the lower part of the branches. *Perichæcial leaves*—outer ones short, broadly ovate at the base, concave, contracted above into a short lingulate obtuse apex; innermost ones with their upper portion longer, and nearly linear, the nerve disappearing beneath the point. *Fruit-stalk* lateral, about three-fourths of an inch in length, pale yellow, slender. *Capsule* oblong; *lid* conical and rostrate. *Peristome* I have not seen.

TABLE XIV. Fig. 1. Plant natural size. 2. Part of a plant magnified. 3. Cauline leaves. 4. Summit of a cauline leaf. 5. Outer perichæatial leaf. 6. Inner do.—All magnified, except Fig. 1.

This interesting Moss unquestionably belongs to the genus *Anomodon* of Drs HOOKER and TAYLOR. Not feeling, however, perfectly convinced of the expediency of that genus, I have preferred, for the present, placing this new species in the genus *Neckera*, at the expence of which *Anomodon* itself was constituted. *Neckera Americana* is very nearly related to *N. viticulosa* (*Anomodon viticulosum*, Musc. Brit.), and has the same peculiar habit, and mode of growth, leaves of the same dense and fragile texture, and a fruitstalk and capsule nearly similar. In size, however, it is much smaller, the leaves are little more than half the length, rounded at the extremity, and the nerve disappears at a considerable distance from the summit. The capsule is also shorter.

The great resemblance between these two mosses cannot escape the most careless muscological observer, and may suggest to many the existence, though in an inferior degree, of the same relation between some of the Cryptogamous plants of Europe and North America that has been detected between numerous Phænogamous plants. It would be hazardous, in the present state of muscology, to dilate on this subject, any more than on the general geographical relations of mosses; especially as from what we do know, we find the observation to be correct, that the lower we descend in the scale of vegetation, the less the distribution of plants over the surface of the globe seems to be regulated by the laws that influence the more perfect vegetable forms. Nevertheless, we do not find in the mosses a disposition to a marked geographical distribution altogether abandoned. The curious genera *Phascum Voitia* and *Tetraphis* seem to be confined to temperate and cold regions, and are

mostly limited to Northern Europe. On the other hand, *Calymperes* requires a considerable temperature; and the genus *Hookeria* containing, according to Dr HOOKER and myself, thirty species, besides doubtful ones, is, with the exception of two species, wholly extra-european. It is also worthy of notice, that, in the extensive genus *Orthotrichum*, of which we have published fifty-nine species, all those not found in Europe and North America, possess a peculiarity of habit at once recognisable, and for the most part also a difference in structure. That singular group, too, of mosses, denominated *Leptostomum* by Mr BROWN, has hitherto been only found in New Holland, Van Dieman's Land, New Zealand, and at Cape Horn. From these few facts alone, selected from various others that might have been brought forward, we have some reason for concluding that, at a future period, the distribution of the mosses will be found to be a more interesting subject than we at present anticipate; and that, even in those large genera, which now appear to scatter species indiscriminately over every country of the globe, sectional groups will be found, affecting perhaps different temperatures and latitudes from the rest.

HYPNUM REMOTIFOLIUM, *Grev.*

H. remotifolium; caule vage ramoso decumbenti, ramis elongatis, laxis; foliis subpatentibus, remotis, lateovatis, acuminulatis, subconcavis, per totam longitudinem serratis nervo infra apicem evanescenti; theca cernua, operculo, conico, oblique rostrato.

HAB. South America, on the ground; communicated by Professor JAMESON.

Plant of a yellow or pale green colour, reddish-brown towards the base. Stems 2—4 inches in length, decumbent, variously divided,

the branches elongated, lax, attenuated towards their extremities, and irregularly set with lax spreading ramuli. *Leaves* shining, remotely and loosely set on the stem, spreading almost horizontally, broadly ovate, with a small acumination, somewhat concave, sharply serrate from the very base to the apex; nerve disappearing below the summit. *Perichæatial leaves* erect, broadly ovate below, suddenly contracting, and terminating in a lanceolate apex, entire and nerveless, and very pellucid. *Fruit-stalk* nearly an inch in length, smooth, red. *Capsule* short, cernuous, deep red. *Lid* shortly conical, with an acute suboblique rostrum.

This species is at first sight so remarkable for the remote and lax manner in which its leaves are set on the stem, that I have given it a name expressive of this character. It is also well marked, by the cauline leaves being serrated from the point of insertion to the apex; those of the perichæatium being quite entire and destitute of a nerve.

Hypnum remotifolium was sent with some other mosses as packing in a chest of geological specimens, which the President of this Society received from South America. It is a proof how easy a thing it is, under some circumstances, to assist scientific investigation, by communicating what appears to be the commonest objects from a distant country. I can assure those gentlemen who have occasion to send packages of minerals and other things from different parts of the world, that, by using mosses, lichens, &c. as materials for packing, they may greatly enrich the collection of the muscologist, and forward the progress of this department of natural history.

EDINBURGH, }
 May 5. 1825. }

XXIX.—*Account of the Method of Drawing Crystals in True Perspective, followed in the Treatise on Mineralogy of Professor MOHS.*

By W. HAIDINGER, Esq. of Vienna, F.R.S.E. Member of the Wernerian Society, &c.

(*Read 14th May 1825.*)

ALL those who have devoted their attention to the study of Crystallography, must have experienced many difficulties arising from the want of a proper method of drawing the projections of crystals, an object which, at the same time, should be effected with perfect ease, and with sufficient accuracy. Those who already possess the required crystallographic knowledge, will, indeed, very soon be capable to draw up rules for themselves; but this knowledge is not yet so generally diffused as it deserves, both for the influence it is likely to take in the progress of the science, and for the wonderful regularity of nature which it displays. The very attempt of drawing crystalline forms is inseparable from a close examination of these, and therefore a step forwards in studying crystallography; we may acquiesce in giving a vague verbal description of a crystal, but a vague representation of its figure seems to imply some im-

possibility for any person who is accustomed to accurate investigations. It is to a great extent the use of correct figures which has given Haüy's crystallographic method that great superiority which it has always enjoyed over the Wernerian method, both in accuracy and elegance; and to the study of Haüy's plates, far more than to the study of his writings, we must look as the point from which the subsequent labours of crystallographers started.

By far the greater number of the figures in the first edition of Haüy's *Traité* are executed with care, and according to the best method which could possibly have been adopted. Since the appearance of that work, most of the authors of crystallographic publications have followed the same plan, while others have more or less deviated from it. Many of the figures contained in the works of the present day, it must be owned, are much inferior to Haüy's, in point of correctness. It is, however, but very lately, that an introduction to a method of projections has been thought worthy to receive a place in systematic works on crystallography, and of these I shall only mention here the *Traité de Crystallographie* by Abbé Haüy, and the *Introduction to Crystallography* by Mr Brooke. The graphic method, which it is the object of this paper to develop, is that followed by Professor Mohs; it is equally distinguished by the easiness in its application, and the accuracy of which it is susceptible.

A useful representation of a crystal must contain every thing remarkable and requisite, for identifying it with the original in nature. Its chief object is, therefore, to express the relative position of the faces, and consequently the parallelism of those edges, which are parallel in the crystals themselves. This object can only be attained, if we suppose the eye of the observer to be at an infinite distance from the solid which is to be represented, in order to have

all those lines parallel which may be drawn from the eye to any of its points whatever. Suppose, now, a plane to cut all these lines, or the visual ray, at right angles; draw perpendicular lines from every solid angle of the solid upon that plane, the intersections with it will be the projections of the solid angles; join these points by straight lines with each other, the result will be a figure representing the crystal itself.

In the art of drawing in perspective, this method is called the Orthographic Projection, on account of the right angle, which the visual ray includes with the plane upon which the solid is represented. Herein it differs from the method followed by several modern authors, in which it is supposed that the eye of the observer is at once in two different places; but it agrees with the method employed in the works of Häüy. If the relations of the simple forms among each other be known, according to the crystallographic methods of Häüy, of Weiss, and others, but, particularly, if attention be given to the derivation of the simple forms from one another, and the laws of their combination, as proposed in the method of Professor Mohs, it will not be attended with the slightest difficulty to draw the figures of the most complicated crystals which may occur, if only the projection of one of the simple forms contained in them, have been previously completed; because the situation of the edges in the compound forms depends solely upon the intersection of the faces of the simple ones, and upon the ratios of certain lines similarly disposed in the single forms, which enter into the combination.

The first object to be attained, will therefore consist in projecting the figure of a form that may answer this purpose; and as the most appropriate, we may select the hexahedron, or, in the purely geometrical mode of considering it, the right rectangular four-sided prism, whose sides are

squares. (Plate XV. Fig. 1.)* It will form the first member of a series of problems, to be considered in two sections, referring to the method of projecting the simple forms, and the combinations, in which they are found in nature.

—◆—

SECTION I.

OF THE PROJECTIONS OF SIMPLE FORMS.

Problem I. *To draw a Hexahedron.*

Suppose one of the faces of the hexahedron (Fig. 1.) to be perpendicular to the visual ray. Its projection upon another plane perpendicular to the same line will also be a square, equal to the above mentioned face of the hexahedron. Suppose this square (Fig. 2.) to revolve round a line MN , parallel to CD ; the points A and B will appear depressed in the lines AC and BD , while the length of CD remains unaltered; the projection of the square, therefore, assumes the appearance of a rectangular parallelogram. But in the hexahedron (Fig. 1.) at the same time, the face $CDEF$ is turned round CD , and the projection of the two faces assumes the figure of two parallelograms (Fig. 3.) If we still continue to revolve the solid in the same way, the projection of AC and BD will diminish in length, while that of CE and DF increases till it becomes equal to CD , when the face $CDEF$ (Fig. 4.) is brought into a plane perpendicular to the visual ray.

If the horizontal line MN is not parallel to CD , Fig. 5., the revolution round it cannot give rise to any rectangular

* For the figures which accompany this paper I have been indebted to Robert Allan, Esq. younger of Laurieston. They have been carefully executed in conformity to the rules which they serve to illustrate.

Fig. 1.

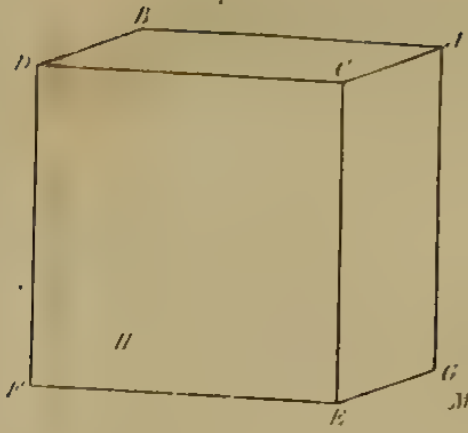

Fig. 2.

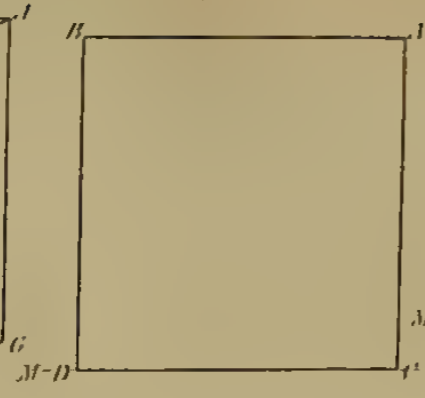

Fig. 3.

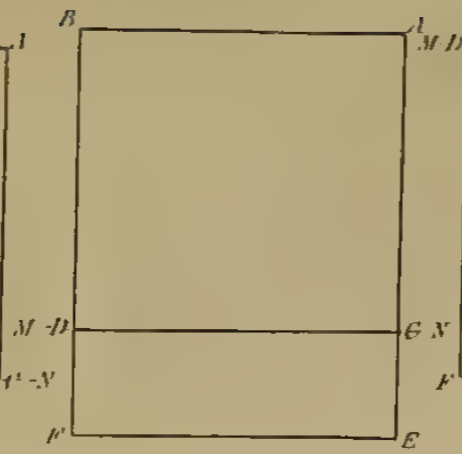

Fig. 4.

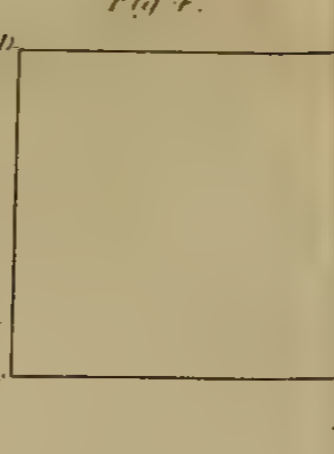

Fig. 5.

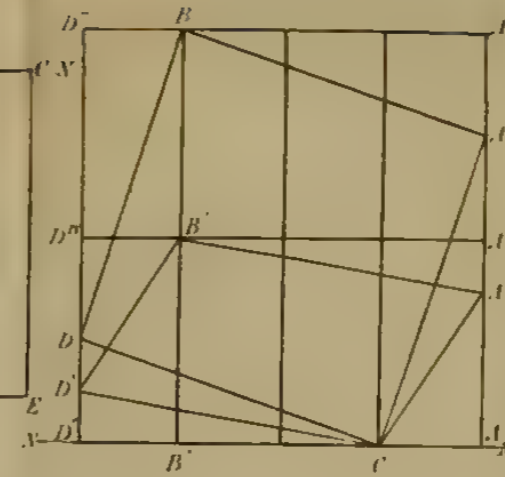

Fig. 6.

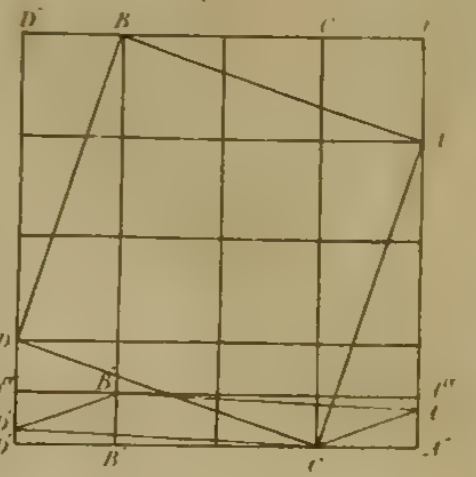

Fig. 7.



Fig. 8.

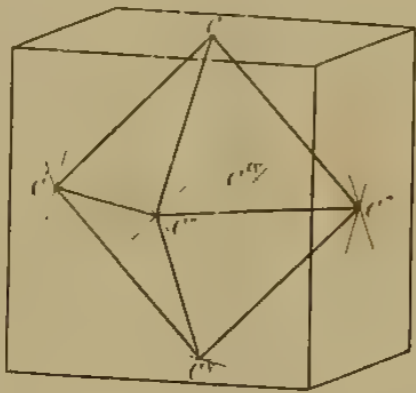

Fig. 9.

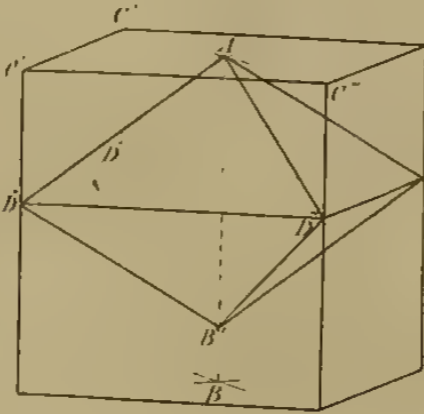

Fig. 10.

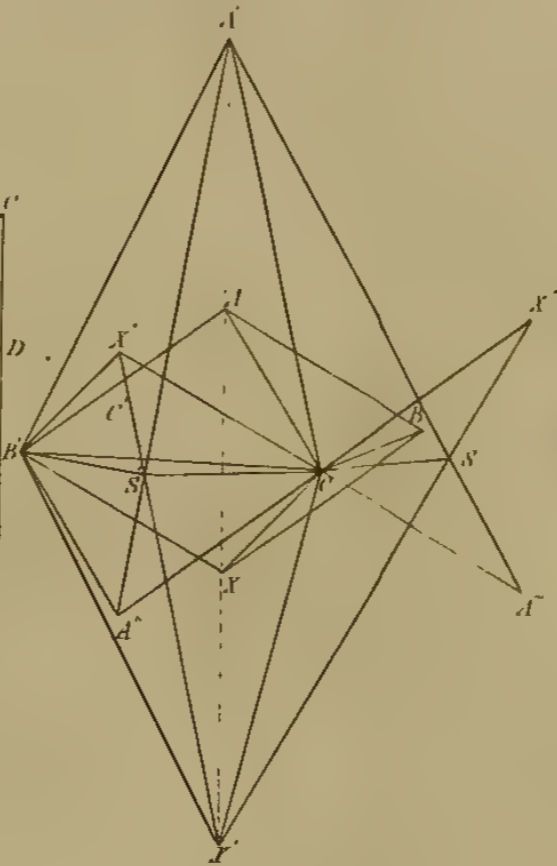

Fig. 11.

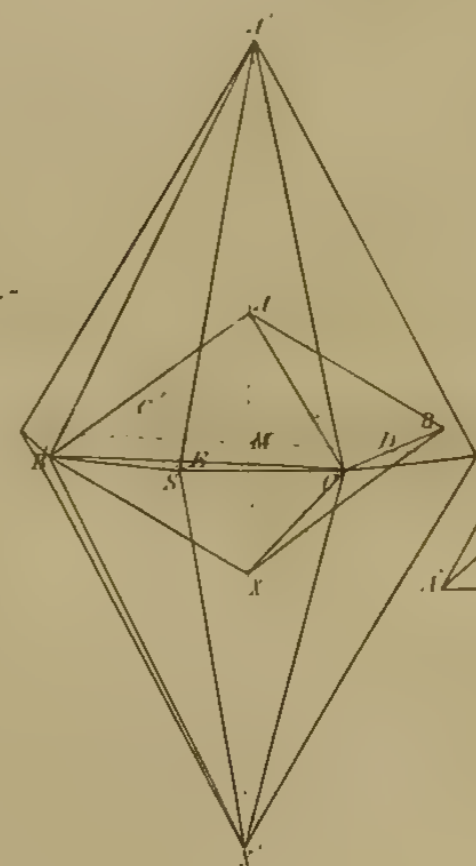

Fig. 12.

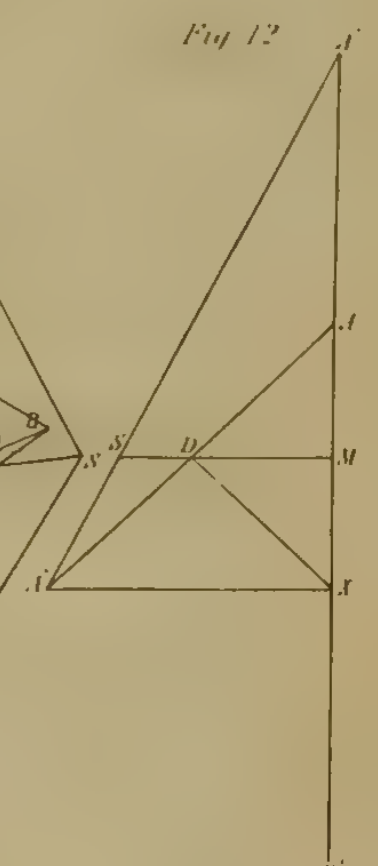

Fig. 13.

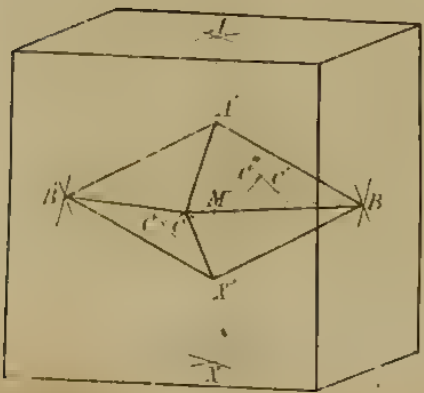

Fig. 14.

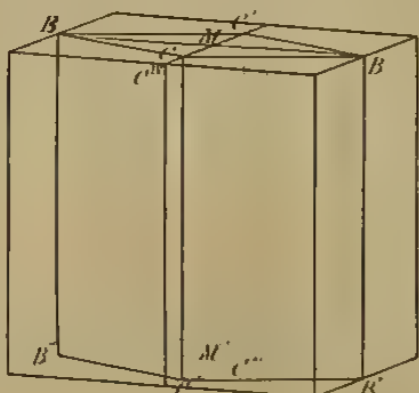

Fig. 15.

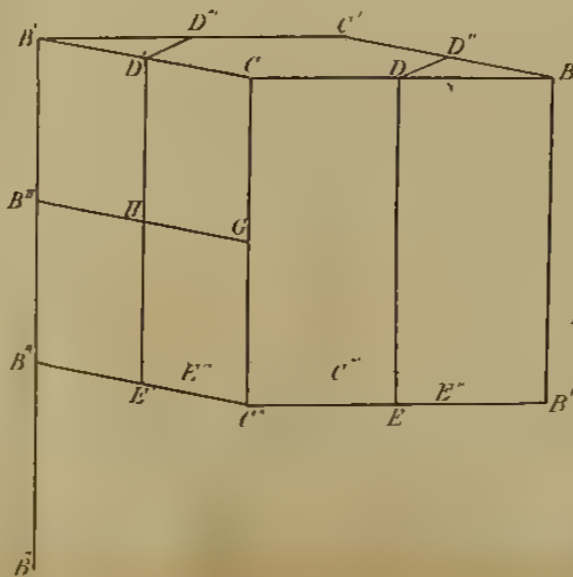

Fig. 16.

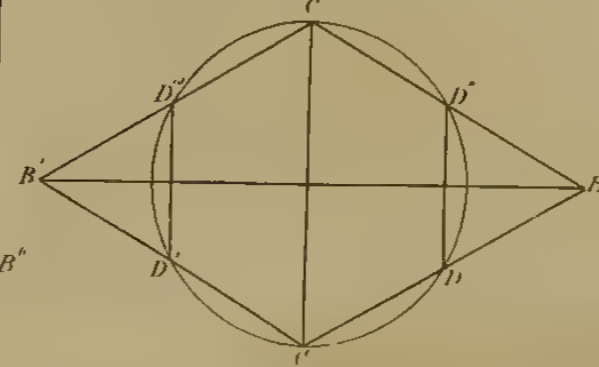

Fig. 17.

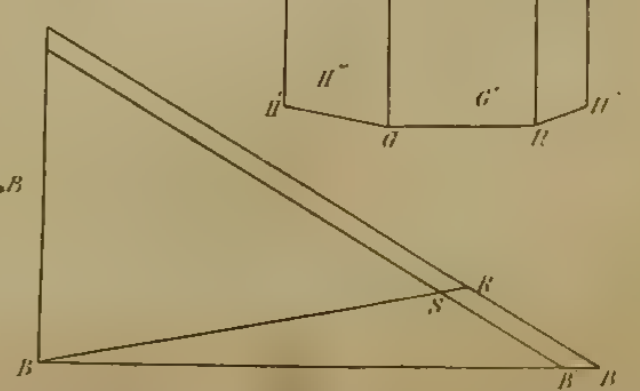
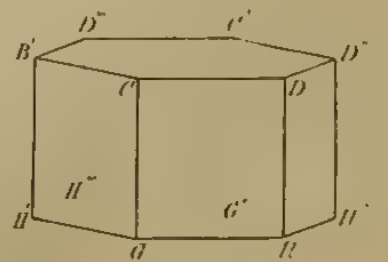
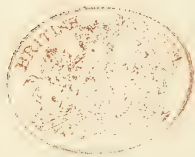

Fig. 18.





figures; for while B moves downwards in the direction of BB'' , A is depressed in that of AA'' , and D in that of DD'' . The limits of this change are, the coincidence of B with B'' , of A with A'' , and of D with D'' , which makes the projection of the angle $BAC = BDC = 0$, that of the angle $ACD = ABD = 180^\circ$. It is evident that the ratio of AA'' to $A'A''$ must be equal to that of BB'' to $B'B''$, and of DD'' to $D'D''$, because we may imagine the square $ABCD$ to be part of a rectangular triangle revolving round one of its sides; a triangle produced in the above figure by lengthening MN till it is intersected by BA and BD . But the ratio of $A^{IV}A^I : A^{IV}A''$ being equal to that of $A^{III}A : A^{III}A''$, it will also be equivalent to that of $A''C : A''D''$, for the equality and similarity of the triangles $BA^{III}A$, $A''C$, $CD''D$, and $DD^{III}B$.

The ratio of $A''C$ to $A''D''$, and that of $B'B''$ to $A''D''$, depend therefore entirely upon the choice of the position in which the hexahedron is to be represented; but the ratio of $A^{IV}A^I$ to $A^I A''$ is a consequence of the two suppositions. If, for instance, we suppose $A''C = \frac{1}{4}A''D''$, and $A^{IV}A'' = \frac{1}{8}A''D''$, the projection of the square upon a plane perpendicular to the visual ray will be that represented Fig. 6., denoted $A^I B^I D^I C$. This is the position adopted in M. Mohs' Works, for the figures of crystals belonging to the pyramidal and tessular systems.

The projection of the square $ABCD$ having thus been obtained, upon a plane perpendicular to the visual ray, it is required to find the length of those lines which in the projection appear vertical, and represent the lateral edges of the hexahedron.

Suppose Fig. 7. to be a vertical section, in the plane of the visual ray. The line BB'' in this figure will be the projection of the face $ABCD$ in Fig. 6. If this line be turned round the point B'' (which is the projection of the

line $A^{II} D^{II}$) till $B^{II} L$ (Fig. 7.) becomes equal to $A^{II} A^{IV}$ (Fig. 6.), the edges of the hexahedron $B K^I$, $B^{II} G^I$ will assume the situation of $B^I K$, $B^{II} G$, and the line $B^{II} H$, which is determined by drawing $G H$ at right angles upon the continuation of $B B^{II}$, will be the required length of the perpendicular lines in the projection.

By the length $B^{II} H$, taken upon $A^{III} A^{II}$, $C^I C$, $B B^{II}$, $D^{III} D^{II}$, from the angles A^I , C , B^I , D^I of the projection of the square, is determined the place of the four other solid angles of the hexahedron, which is thus completed, similar to Fig. 1.

In order to express these processes analytically, let $A^{II} D^{II}$, the distance of the two extreme edges, be $= a$; $A^{II} C$, the distance of one of these from the adjacent interior one, $= \frac{a}{n}$; $A^{IV} A^{II}$, the height of the projection of the terminal square, $= \frac{a}{m}$; and, moreover, the length of an edge of the hexahedron $= b$.

From the rectangular triangle $D C D^{II}$ follows,

$$b = \frac{a}{m n} \sqrt{(m^2 (n - 1)^2 + n^2)};$$

And from the similarity of the triangles $B^I L B^{II}$ and $B^{II} H G$, Fig. 7.,

$$B^{II} H = b \sqrt{\frac{m^2 - 1}{m^2}}.$$

If, as in M. Mohs' Works, $A^{II} C$ is $= \frac{a}{4}$, $A^{IV} A^{II} = \frac{a}{8}$, or $m = 8$, and $n = 4$, we have

$$b = a \sqrt{\frac{37}{64}}, \text{ and}$$

$$B^{II} H = b \sqrt{\frac{63}{64}} = a \frac{\sqrt{63 \times 37}}{64}.$$

Thus it appears that this method of projection may, with

the greatest facility, be subjected to such calculations as should be rendered necessary by some particular question; but it will be always found more convenient to follow the graphic process developed above, in which the only thing required for attaining the greatest precision, is some accuracy in employing rulers and compasses.

Having succeeded in projecting the hexahedron, we find ourselves enabled to resolve a great many problems respecting crystallographic drawings, some of which may here be considered, in order to attach to them a few observations relative to certain advantages in executing the projection.

Problem II. To draw a regular Octahedron.

If the octahedron and the hexahedron are brought into a parallel position, the only one in which they are produced by nature in one and the same crystal, the pyramidal axes of one of these forms coincide with the pyramidal axes of the other, and consequently there will exist an octahedron, whose size is exactly such, that its solid angles touch the faces of the hexahedron in their centres. Hence, determine the centres of these faces C , C^I , C^{II} , C^{III} , C^{IV} , and C^V , Fig. 8., and join them by straight lines, the result will be the octahedron.

Problem III. To draw a given Isosceles Four-sided Pyramid, for instance, P of Pyramidal Zircon.

According to Mohs, a in this species is $= \sqrt{0.8204}$,* that is to say, the axis of the pyramid P is $= \sqrt{0.8204}$, the side

* 'Treatise on Mineralogy,' vol. ii. p. 368. The measurements upon which this quantity depends, were taken upon the small, but beautifully formed, crystals which accompany the native platina, and agree exactly with the results obtained by Dr Wollaston, and Messrs Brooke and Phillips.

of its horizontal projection being = 1. Draw AB the vertical pyramidal axis of the hexahedron, Fig. 9. Take $AB^I = AB\sqrt{0.8204}$, $CD = C^I D^I = C^{II} D^{II} = C^{III} D^{III} = \frac{1}{2} AB\sqrt{0.8204}$, and join the lateral angles D, D^I, D^{II}, D^{III} by straight lines with the apices A and B^I of the pyramid; the result is the required pyramid P of pyramidal Zircon.

Problem IV. *To draw the Pyramid (P)⁵ of Pyramidal Zircon.*

We obtain an eight-sided pyramid by the following process. 1. Produce the axis of the four-sided pyramid on both sides to an indefinite, but equal length; 2. Enlarge the faces of that four-sided pyramid from which the eight-sided one is to be derived; 3. Draw triangles upon them, equal and similar to those of the pyramid, the bases of the triangles coinciding with the base of the pyramid; 4. Join the lower points thus determined with the upper apex, the upper points with the lower apex of the lengthened axis; and, 5. Pass planes through every one of these lines and the adjacent lateral solid angles of the original pyramid.

The rule for drawing the figure of an eight-sided pyramid will therefore be thus. Project the four-sided pyramid as above. Lengthen the axis AX (Fig. 10) till $A^I X^I$ is $= 3 AX$, the pyramid required being $(P)^5$. Draw $CA^{II} B^I$ equal, similar, and opposite to CAB^I in the prolongation of its plane; in like manner $CX^{II} B^I, CX^{III} B, CA^{III} B, \&c.$ Join $A^{II}, A^{III}, \&c.$ with A^I ; $X^{II}, X^{III}, \&c.$ with X^I ; B, C, B, X^I with both A^I and X^I , and also with the intersections $S, S^I, \&c.$ produced by the lines $A^I A^{III}$ with $X^I X^{III}$, $A^I A^{II}$ with $X^I X^{II}$, &c. The result will be the projection of the pyramid $(P)^5$.

The same pyramid will also be obtained by proceeding

upon the following rule. Project the isosceles four-sided pyramid $A B C B^I C^I X$ (Fig. 11.) as above. Bisect its lateral edges, $B C$ in D , $C B^I$ in E , &c. In the continuation of $M D$, $M E$, &c. take $S D = \frac{1}{2} M D$, $S^I E = \frac{1}{2} M E$, &c. and join all the points S , C , S^I , B^I , &c. by straight lines with the terminal points A^I and X^I of the lengthened axis, and the adjacent ones among themselves.

The latter process, being shorter, is preferable to the former one. It depends upon the property of the eight-sided pyramids, that $S D$ (Fig. 12.) is always equal to $\frac{m-1}{m+1} \cdot M D$, m being the number of derivation of the pyramid. For, let $A X$ be $= a$, $A^I X^I = m \cdot a$, $A^I M$ will be $= \frac{m}{2} \cdot a$, and $A^I X = \frac{m+1}{2} \cdot a$.

$$\text{Now, } A^I M : M S = A^I X : X A^{III},$$

$$\text{and } M S = \frac{A^I M \times X A^{III}}{A^I X}.$$

$$\text{But } A^I M = \frac{m}{2} a, \quad X A^{III} = 2 M D, \quad \text{and } A^I X = \frac{m+1}{2} a;$$

$$\text{therefore } M S = \frac{2 m}{m+1} \cdot M D,$$

$$\text{and } S D = S M - M D = \left(\frac{2 m}{m+1} - 1 \right) M D = \frac{m-1}{m+1} \cdot M D.$$

In the present case, m being $= 3$, $S D$ is $= \frac{3-1}{3+1} \cdot M D = \frac{1}{2} \cdot M D$. The values of m most generally occurring in crystals, besides 3 , are 4 and 5 ; these make $S D = \frac{2}{5} \cdot M D$ for $(P)^4$, and $= \frac{2}{3} \cdot M D$ for $(P)^5$.

Problem V. *To draw a Scalene Four-sided Pyramid, for instance, that of Prismatic Topaz.*

According to Mohs, the ratio of the axis, and the two diagonals of the base in this species, or $a : b : c$ is $= 1 : \sqrt{4.440} : \sqrt{1.238}$, or $= \sqrt{\frac{1}{4.440}} : 1 : \sqrt{\frac{1.238}{4.440}}$.

Draw the pyramidal axes $A X$, $B B^I$ and $C C^I$ of the hexahedron (Fig. 13.). Take $A^I M = X^I M = A M \cdot \sqrt{\frac{1}{4.440}}$, $C^{II} M = C^{III} M = C M \cdot \sqrt{\frac{1.238}{4.440}}$, and join the six points $A^I B C^{II} B^I C^{III} X^I$ by straight lines, the result will be the projection of the required pyramid. The numerical values must be expressed in decimals, and taken from a scale.

Problem VI. *To draw a Right Rhombic Prism.*

It is evident, that the projection of any oblique-angular four-sided prism will be as easily obtained as the projection of a scalene four-sided pyramid, if we suppose it, in a similar manner, to be inscribed into the hexahedron. The prism being a pyramid, one of the axes of which only is infinite, the present case forms a corollary of the preceding one.

Let, for instance, the prism (Fig. 14.) which is to be represented, be that, whose transverse section is similar to the base of P in prismatic Topaz, or $P + \infty$. The line $M C = M C^I = M^I C^{II} = M^I C^{III}$, will be equal to $M C^{IV} \sqrt{\frac{1.238}{4.440}}$.

Problem VII. *To draw a regular six-sided Prism.*

If MC be $= MC^{IV} \cdot \frac{1}{\sqrt{3}}$, the real transverse section of

the prism will be a rhomb of 120° and 60° ; and the prism itself may be transformed into a regular six-sided one, by truncating its more acute lateral edges $B^I B^{III}$, and $B B^{II}$ (Fig. 15.), and allowing the planes of truncation to pass through the centres $D^I, D^{III}, E^{III}, E^I$, &c. of the respective lines $C B^I, C^I B^I, C^{II} B^{III}, C^{III} B^{III}$, &c.

That this must give a correct result, appears, if we consider (Fig. 16.) the projection upon a plane parallel to the rhomb $BC^I B^I C$. The angle $D^{III} B^I D^I$ is $= 60^\circ$, the triangle $D^{III} B^I D^I$ is therefore equilateral; now, in the regular hexagonal prism $C^I D^{III}$ must be $= D^{III} D^I$, and therefore likewise $= D^{III} B^I = \frac{1}{2} C^I B^I$.

Problem VIII. *To draw a regular six-sided Prism, whose lateral Planes are Squares.*

From the known equality of BB^I and $B^I B^{III}$ in Fig. 14. inasmuch as these projections have been obtained from a hexahedron, it will not be difficult to find the length of CC^I required for transforming $CC^{II} E^I D^I$, and consequently all the lateral faces of the six-sided prism into squares.

Suppose BB^I to be $= 1$; BC , in the solid itself, will be $= \frac{1}{\sqrt{3}}$, and CD^I therefore $\frac{1}{2\sqrt{3}}$. The portion $B^I B^{IV}$, that must be taken from that line $B^I B^{III}$, in order to transform $CD^I HG$ into a square, must be to that line in the ratio of $\frac{1}{2\sqrt{3}} : 1$, or $B^I B^{IV} = CG$ must be $= \frac{B^I B^{III}}{2\sqrt{3}}$,

PLATE XVI.

Engl^d for the Wern Memoirs Vol V p. 497.

Fig. 1.

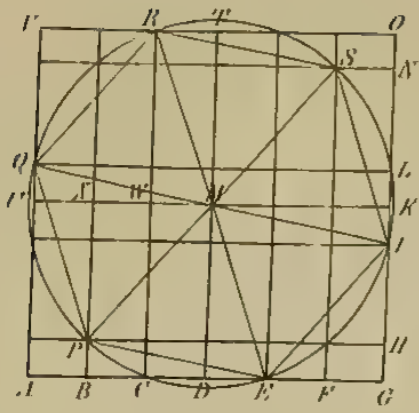

Fig. 2.

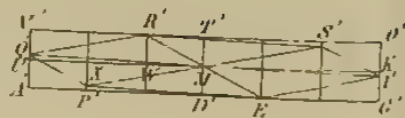

Fig. 3.



Fig. 4.

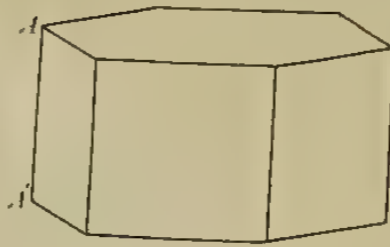

Fig. 5.

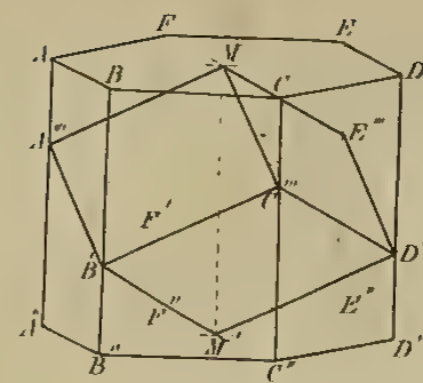

Fig. 6.

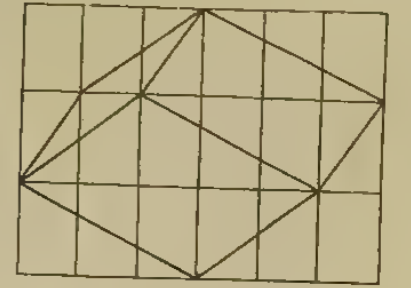

Fig. 7.

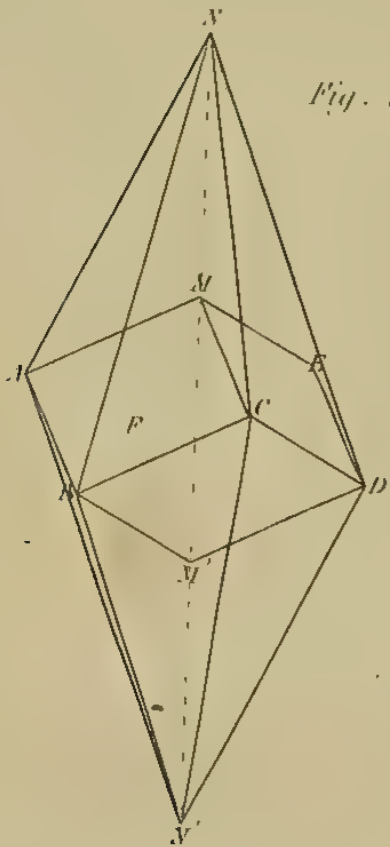

Fig. 8.

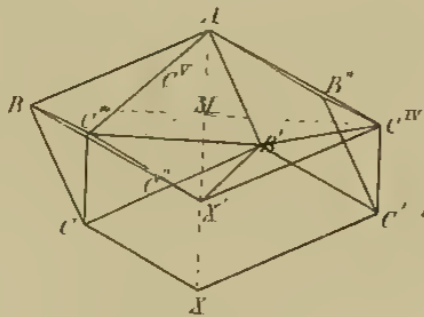

Fig. 9.

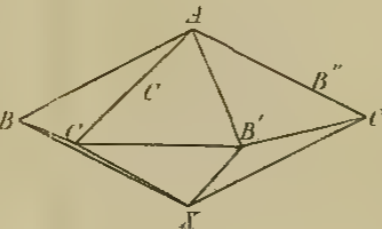

Fig. 10.

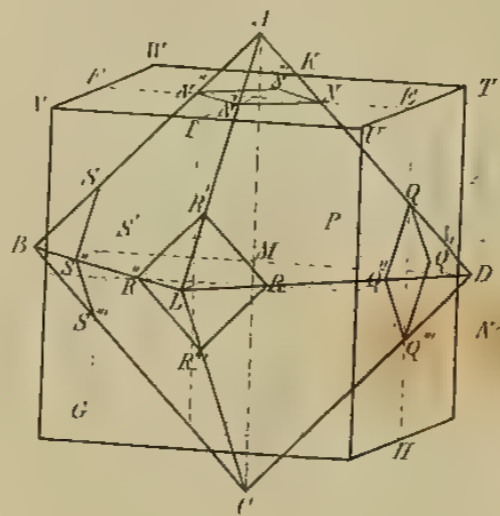

Fig. 11.

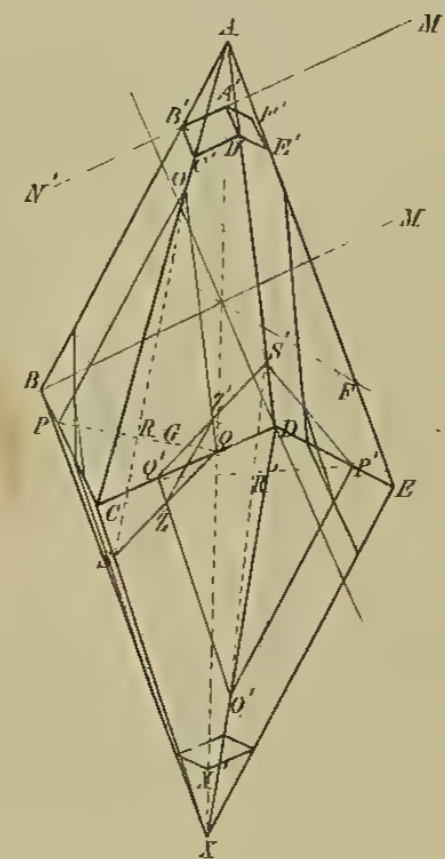

Fig. 12.

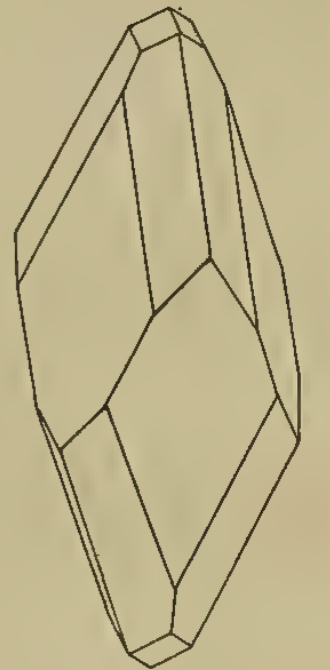

Fig. 16.

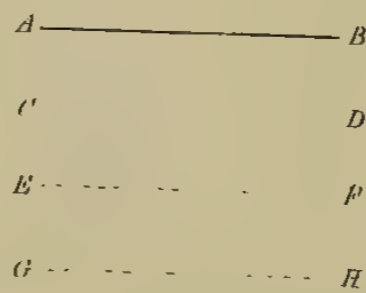

Fig. 13.

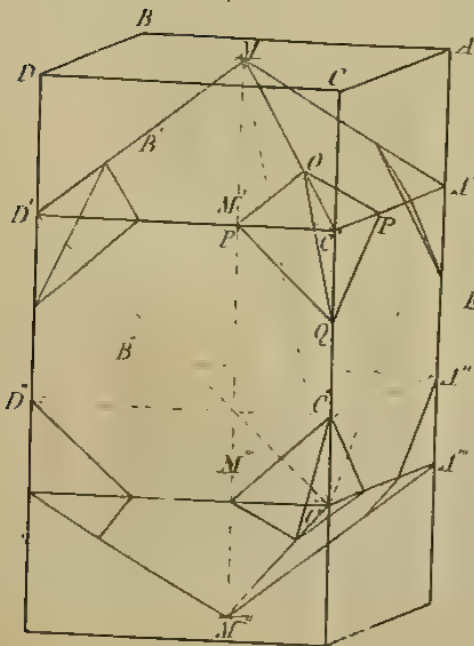

Fig. 14.

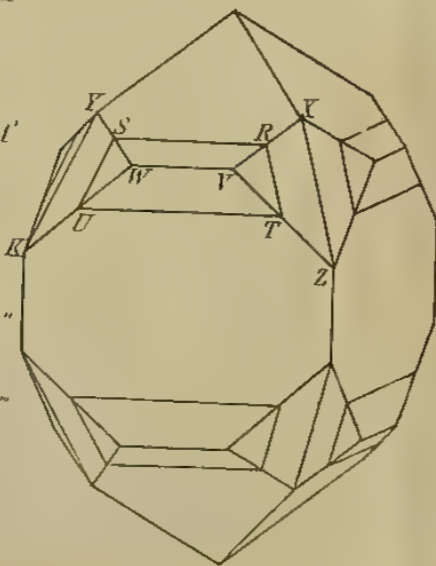

Fig. 15.

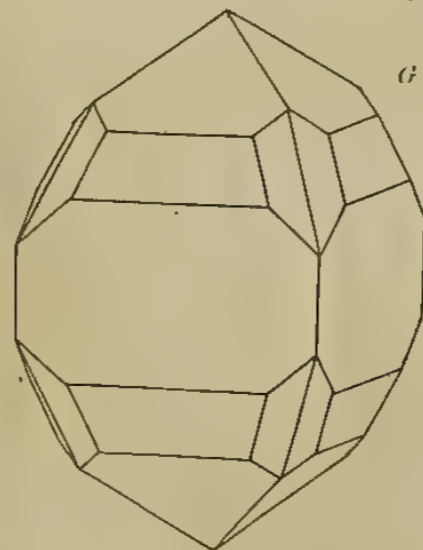
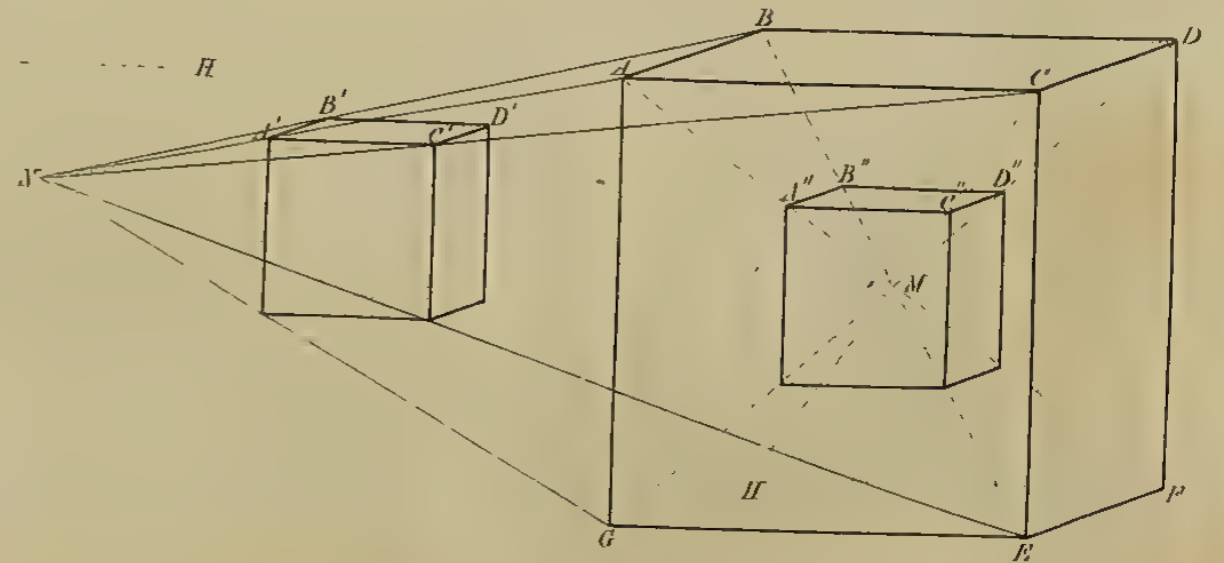

Fig. 17.



AB must always be = CD = DE = FG. In the figures of Professor Mohs' Treatise on Mineralogy it is = $\frac{1}{8}$ AG.

It is evident, that if $R^I W = \frac{1}{n} R W$, also $P^I X$ must be $\frac{1}{n} P X$, and $Q^I U = \frac{1}{n} Q U$. The ratio of ON : OG is dependent upon that of AB : AG, and is found by drawing perpendicular lines from all the angles of the hexagon upon the line OG, which is situated in a plane parallel to the visual ray. If AB : AD = 1 : 3, we obtain ON : OK = 1 : 5.

The apparent length of the lateral edges of the prism, the faces being squares, is found in the following way. Draw AB perpendicular to BD (Fig. 3.), BD being a vertical section of the plane upon which the figure is to be represented. Take BC = O^I G^I (Fig. 2.), and AC = TD, Fig. 1. Draw CE perpendicular to AC, and equal in length to PE (Fig. 1.); from the point E draw ED perpendicular to BD, the line CD will be the required length of the lateral edges of the hexagonal prism, which, applied to the projection of the terminal hexagon in Fig. 2., yields Fig. 4. the projection of the hexagonal prism itself.

This method of projecting a regular six-sided prism may likewise be conceived in analytical terms.

From the ratio of AB : AD (Fig. 1. Plate XVI.) being known, it will be possible to deduce that of ON : OK.

Let AD be = a , OK = b , AB = $\frac{a}{n}$, ON = $\frac{b}{m}$; and

PE = EI = IS = c . We derive the following equations:

$$PE^2 = PB^2 + BE^2; EI^2 = EG^2 + GI^2; SI^2 = IN^2 + NS^2, \text{ or}$$

$$= \left(\frac{b}{m}\right)^2 + a^2; c^2 = \left(a - \frac{a}{n}\right)^2 + \left(b - \frac{b}{m}\right)^2; c^2 = b^2 + \left(\frac{a}{n}\right)^2$$

and consequently, by eliminating c from the two first we obtain

$$b^2 = \frac{(1 - 2n)m}{(2 - m)n^2} \cdot a^2;$$

from the two last,

$$b^2 = \frac{(2 - n)m^2}{(1 - 2m)n^2} \cdot a^2;$$

and therefore $\frac{(1 - 2n)m}{(2 - m)n^2} = \frac{(2 - n)m^2}{(1 - 2m)n}$;

which being resolved, gives

$$m^2 n^2 - 2m^2 n - 2m n^2 + 2m + 2n - 1 = 0,$$

$$m = \frac{n^2 - 1 \pm \sqrt{(1 - 2n + 3n^2 - 2n^5 + n^4)}}{n(n - 2)}, \text{ and}$$

$$n = \frac{m^2 - 1 \pm \sqrt{(1 - 2m + 3m^2 - 2m^5 + m^4)}}{m(m - 2)}.$$

For $n = 3$, m becomes $= \frac{8 \pm 7}{3} = \frac{1}{3}$ or 5, the former of which is excluded by comparing the result with the figure, and the only value left for m is $= 5$. The line ON , therefore, is $= \frac{1}{3} OK = \frac{1}{3} b$. The ratio of the lines a and b themselves, being expressed by $\frac{b^2}{a^2} = \frac{(1 - 2n)m}{(2 - m)n^2}$, is $= \sqrt{25} : \sqrt{27} = 5 : 3\sqrt{3}$.

The apparent length CD of the edge CE , parallel to the axis of the six-sided prism, is obtained from the similarity of the triangles CED and ACB , and found to be $= c\sqrt{\left(\frac{p^2 - 1}{p^2}\right)}$, if we suppose $BC = \frac{b}{p}$, and c the real length of one of the sides of the regular hexagon. Since, by the preceding formulæ, c , as well as b , may be expressed by a and n , it will not be difficult also to express the length CD by means of the same quantities, although the expression thus obtained will not be so simple as that stated above.

The projection of a regular hexagonal prism, which is a member of the rhombohedral system, allows of a similar application in regard to forms of the same system, as the projection of the hexahedron in the forms of other systems.

Problem X. *To draw a Rhombohedron.*

Let, for instance, this rhombohedron be the one whose terminal edge is $= 104^\circ 28' 40''$, the same which Abbé Haüy considered as the primitive form of calcareous spar. Its axis is $= 1.5 = 2.25$.

Draw the regular hexagonal prism, whose sides are squares, in the position fixed upon, Fig. 5. Produce the lateral edges, till AA^{II} is $= \frac{3}{2} AA^I$, equal to the given axis of the rhombohedron. Take one-third of the length of these lateral edges alternately from the upper and the lower hexagon, and join the points A^{III} , B^I , C^{III} , D^I , E^{III} , F^I , thus determined among each other and with the centres M , M^I of the adjacent terminal hexagons by straight lines. The result will be the projection of the given rhombohedron. The projection of the actual fundamental rhombohedron of rhombohedral lime-haloide is obtained, if, instead of taking $AA^{II} = \frac{3}{2} AA^I$, we substitute the value $= \sqrt{2.1895} AA^I$.

If MM^I or AA^{II} is $= AA^I \cdot \sqrt{4.5}$, the projected solid is the hexahedron.

If $O^I G^I$, in Fig. 2., is $= 0$, the method of drawing a rhombohedron becomes very simple, since it requires only to draw the vertical lines representing the projections of the lateral sides and the axis of the hexagonal prism at the regular distances (at equal distances, for $A^I P^I = \frac{1}{6} A^I G^I$, in Fig. 2.) from each other, and cross them at right angles by four equidistant horizontal lines, whose intersections

with the former determine the situation of the angles of the rhombohedron, as it appears from the inspection of the 6th figure.

Problem XI. *To draw a Scalene Six-sided Pyramid, for instance, (P)³ of rhombohedral Lime-haloide, or the “variété métastatique” of Haiüy.*

Having completed the projection $M A B C D E F M^I$ (Fig. 7.) of the rhombohedron R , take $N M = M M^I = M^I N^I$, because here the number of derivation is $= 3$, which requires $N N^I$ to be $= 3 M M^I$. Join the ends of the lengthened axis with the lateral angles of the rhombohedron by straight lines; the result will be the projection of the required scalene six-sided pyramid.

Problem XII. *To draw an Isosceles Six-sided Pyramid, for instance, P, or that which belongs to the Rhombohedron R of the same species.*

Project (Fig. 8.) the rhombohedron $A B B^I B^{II} C C^I C^{II} X$, and take $A M = X^I X$. Draw $C C^{III}$, $C^I C^{IV}$, $C^{II} C^V$ parallel to the axis $A X$, and lengthen the lines $B M$, $B^I M$, $B^{II} M$, till they intersect the former in C^{IV} , C^V , C^{III} . Join the points B , C^{III} , B^I , C^{IV} , B^{II} , C^V , with each other, and with the points A and X^I , equidistant from M , the result will be the projection of the isosceles six-sided pyramid P , as it is represented in Fig. 9.

The preceding cases will suffice for obtaining the projection of any simple form we may desire, if the rules laid down in this respect be properly seconded by a knowledge

of the relations of the forms themselves, and of the relations they bear to each other. It will be useful, however, to illustrate, by a few examples, the method of drawing the figures of combinations.

SECTION II.

OF THE PROJECTIONS OF COMPOUND FORMS.

Compound forms or combinations, in general, are those crystalline figures, which at the same time shew the faces of two or more simple forms. Every one of these may be obtained by sufficiently enlarging those faces which, in the compound form, are equal and similar to each other. The form of the combination may be defined to be the space included at the same time within all the forms entering into the combination. Hence the method of representing them in its greatest generality, will require to lay down, in the parallel position, the figures of all those simple forms which the combination contains, and to determine that part of them which, if they intersect each other, is not excluded by any one of these simple forms. In most cases we may dispense with proceeding upon this long and very often tedious way, but it will be necessary to shew it in an example.

Problem I. *To draw the Combination of the Hexahedron and the Octahedron.*

Project the two simple forms in parallel position, so that their centres may coincide in M, Fig. 10.

If we draw EF' parallel to DB, and IK parallel to LP, through the centres of the respective edges of the hexahe-

dron, these lines will determine the situation of the points N , N^{II} , and N^{I} , N^{III} , in which the edges contiguous to one of the angles of the octahedron rise from the planes within which the hexahedron is contained. The part $A N N^{\text{I}} N^{\text{II}} N^{\text{III}}$, situated beyond the face $T U V W$ of the hexahedron, will therefore be cut off by this face, and not appear in the combination at all. The same will be the case with all the other solid angles of the octahedron, and the combination itself will be contained under eight hexagons, the residue of the faces of the octahedron, and six squares, being the residue of the faces of the hexahedron.

The same result may be obtained by a shorter process, thus:

Project the figure of the octahedron, take $A N^{\text{I}} = R^{\text{I}} L$
 $= \frac{1}{n} A L$, $A N^{\text{II}} = S B = \frac{1}{n} A B$, $L R^{\text{II}} = S^{\text{II}} B = \frac{1}{n} L B$,
 and draw $N^{\text{I}} N^{\text{II}}$, $S S^{\text{II}}$, $R^{\text{I}} R^{\text{II}}$, which are the intersections of the face $A B L$ of the octahedron with the three adjacent faces of the hexahedron. The same process applied to all the edges of the octahedron gives the intersections of all the faces of the two solids, which being expressed by straight lines, yield the projection of the combination wanted.

Having obtained the figure of a double combination, it will be easy to add the faces of a third, then of a fourth simple form, and so on; and here, as well as in the projection of the simple forms themselves, we may often take advantage of many circumstances, which will offer themselves to our attention in the practical attempt of laying down the representations of crystals, in the proportion of our actual information in regard to the various departments of crystallography.

Problem II. *To draw the Rhombohedral Combination R. (P)⁵. R+2, of the Species of Rhombohedral Limehaloide.*

Before all, it is necessary to fix the relative extent which the faces belonging to the different forms are meant to possess, in order to ascertain which of the simple forms is to be projected first, and the others applied to it, according to the rules of derivation and of combination. Nothing is more easy, if the combination contains only a few simple forms; but it requires some practice to find out the best order in which one of the simple forms is to be added after the other, if the combination contains a great number of them. A short time, however, devoted to the projections of the simple forms themselves, is the best assistance for those who intend to occupy themselves with representing combinations. In the present case, it will be most advisable to begin with the scalene six-sided pyramid (P)⁵, and the process itself will therefore be as follows.

Project the pyramid (P)⁵ or A B C D E F G X, Fig. 11, according to the rules given above (Sect. I. Probl. XI.) The edges of combination between R and (P)⁵ are parallel to the opposite terminal edges of the rhombohedron, and to the lateral edges of the pyramid. The point C^I in which one of the faces of R intersects the edge A C of the pyramid, and consequently the ratio of A C^I to A C having been determined, it is required to draw the edge of combination C^I D^I parallel to the lateral edge C D of the pyramid, and likewise C^I B^I parallel to C B. By this process the ratio of A B^I : A B becomes equal to that of A C^I : A C, and so all round, till all the points B^I C^I D^I E^I F^I G^I have been determined, and those lines drawn which join these points with each other, and represent the edges of combi-

nation between R and $(P)^5$. A line $M^1 N^1$ parallel to $C^1 D^1$, or $C D$, or to $M N$, the edges of the rhombohedron R , and passing through the point B^1 , denotes the direction of one of the terminal edges of R ; its intersection with the axis $A X$, or A^1 , is the apex of the rhombohedron itself, which enters into the combination. The lines $A^1 D^1$, $A^1 F^1$ joining this apex with the upper solid angles of the combination, complete the figure on this side of the centre; on the opposite side of which the same process must be gone through.

The third form to be combined with the combination of R and $(P)^5$ is $R + 2$, an acute rhombohedron, whose edges of combination with $(P)^5$ are parallel to the more acute terminal edges of the pyramid. A face of this rhombohedron, passing through an arbitrary point O of the obtuse terminal edge $A C$ of the pyramid, will therefore produce the edges of combination $O P$ and $O Q$, being the intersections of that plane with those of the pyramid $A B C$, and $A C D$. In order to find the point S , where the face of $R + 2$ intersects the lower opposite edge $C X$, take $P R = R Q$, and draw $O R$, which, duly lengthened, will intersect $C X$ in S . The face $O P S Q$ will represent one of the faces of $R + 2$, as it appears in the combination. There are six of these faces, three of them inclined to the upper apex, the three others inclined to the lower apex; one of the latter is $O^1 P^1 S^1 Q^1$ in the figure. But the faces $O P S Q$ and $O^1 P^1 S^1 Q^1$ intersect each other in the line $Z Z^1$, which line is the lateral edge of $R + 2$, and, as such, parallel to $O P$ and $O^1 P^1$, the edges of combination between this rhombohedron and the pyramid $(P)^5$, or $A B$ and $X E$ the terminal edges of the latter form itself. The result, in completing the combination, by drawing the four remaining faces of $R + 2$, is the form represented in Fig. 12.

Problem III. *To draw the Pyramidal Combination P.*

$(P)^5$. $\frac{3}{2\sqrt{2}} P + 3$. $P + \infty$, *of the Species of Pyramidal Zircon.*

Project the hexahedron $ABCD A^{II} B^{II} C^{II} D^{II}$ (Fig. 13.) according to the rules given above (Sect. I. Probl. I.). Take $A A^I = \frac{1}{2} A A^{II} \cdot \sqrt{0.8204} = C C^I = D D^I = B B^I$. By joining the points A with D , and B with C , determine the situation of M , the centre of the square $ACDB$; and, finally, draw the lines $M B^I$, $M A^I$, &c. and $B^I A^I$, $A^I C^I$, &c. The result $M B^I A^I C^I D^I$ is one part of the isosceles four-sided pyramid required, which, if likewise applied on the opposite side of the axis $M M^I$, will complete the combination of P with $P + \infty$. The length $A^I A^{III}$, &c. is quite indifferent, and depends upon the relative size of the same lines in those natural combinations which are to be represented.

The next form to be added is $(P)^5$.

Take $C^I O = \frac{1}{3} C M$, $C^I P = \frac{1}{3} C^I A^I$, $C^I P^I = \frac{1}{3} C^I D^I$, and $C^I Q = \frac{2}{3} C C^I$, or in general $C^I O = \frac{1}{n} C M$, $C^I P = \frac{1}{n} C^I A^I$, $C^I P^I = \frac{1}{n} C^I D^I$, and $C^I Q = \frac{2}{n} \cdot C C^I$, and draw the lines $O P$, $O Q$, $O P$, and $P Q$, $P^I Q$; the faces $O P Q$, $O P^I Q$ will be those parts of the faces of $(P)^5$, which appear in the combination. This becomes quite evident, if we consider the dimensions of that eight-sided pyramid, and its relations to P . Since $(P)^5$ belongs immediately to this four-sided pyramid P , the edges of combination between the two forms must be parallel to the opposite terminal edges of the latter, $O P$ therefore parallel to $M A^I$; and if this edge of combination be supposed to coincide

with the terminal edge MA^I , that part MM^{III} of the axis, which corresponds to its terminal edge MC^{III} , must be equal to three times the part MM^I , which corresponds to the terminal edge MC^I of the four-sided pyramid. The last is indicated by the exponent 3 in the sign of the eight-sided pyramid. If the same process, by which the faces OPQ and OP^IQ have been obtained contiguous to the angle C^I , be applied to every one of the other solid angles similarly situated, all the faces of $(P)^5$, sixteen in number, will be produced, and thus the triple combination $P. (P)^5. P + \infty$ completed, as it is represented in Fig. 14.

The fourth and last of the simple forms to be added to the preceding combination is $\frac{3}{2\sqrt{2}}P+3$. The axis of $P+3$ is $= 2\sqrt{2}. a$, a being the axis of P ; that of $\frac{3}{2\sqrt{2}}P+3$ therefore $= 3.a$. A face of this form, passing through the point C^{III} , or through the horizontal line $A^{III}C^{III}$, will at the same time pass through the line MC^{III} , which is one of the terminal edges of $(P)^5$. The edges of combination between these two forms are therefore parallel to the alternating terminal edges of the eight-sided pyramid, and also to the terminal edges of the four-sided pyramid. Hence the quadrangle $RSUT$ in Fig. 14. will be one of its faces, the angles of which are determined by taking $WS = \frac{1}{n}WY$, $VR = \frac{1}{n}VX$, $VT = \frac{1}{n}VZ$, and $WU = \frac{1}{n}WK$. The junction of these points by straight lines gives the outline of the face. If repeated on all the homologous edges, this process finally yields the 15th figure for the pyramidal combination of $P. (P)^5. \frac{3}{2\sqrt{2}}P+3. P + \infty$, in the species of pyramidal Zircon.

It would be superfluous to give here a greater number of examples for the process of representing complicated forms of crystals, as it is exactly similar, in every instance, also in the remaining systems of crystallisation. In many cases it may be useful, beside the actual representation of a crystal in perspective, according to the rules developed above, to sketch the horizontal projection, or the elevation of the crystal upon a certain plane, determined in respect to the axes of the combinations; it will be particularly important to make use of this method in hemi-prismatic and tetarto-prismatic forms, in which we are compelled to seek for symmetry, as referred to certain planes; while, in the other systems, it possesses an absolute and persistent character. In the latter, indeed, as Haüy observed, it would have the effect of monotony; but it cannot be too much recommended to those, who already possess some knowledge of forms, for studying certain classes of the more difficult crystals in nature.

The result of applying the rules of projection to a particular case, is the representation of a variety given, or observed in nature upon a plane, without the auxiliary lines, which it was necessary to make use of for arriving at this result. To this end, we copy the points determined by the intersection of the lines, by means of the fine point of a needle, and join the points transferred in this way from one sheet of paper upon another, by means of straight lines, according to the indications of the original drawing. One original may thus serve for a great number of projections, since it may be copied whenever a new form is added; and the degree of attention bestowed upon the first outline is amply repaid by the exactness of the copies.

It has been the custom of Haüy and subsequent crystallographers, and it deserves to be retained, to draw the front edges in full lines, like AB, Fig. 16.; the back edges, like

C D, in dotted lines ; to express lines drawn upon the surface of forms in interrupted lines E F ; and lines in their interior by alternating dots and short lines, like G H.

Very often it occurs, particularly with beginners, who are not yet accustomed to judge rightly of the probable size of a form, to be obtained by several successive processes, that the result is either smaller or larger than is wished for, and a method is therefore desirable for enlarging or reducing it to a more convenient size. Draw to this end from any determined point, within or without the figure, towards every solid angle of the figure, a straight line, and take respectively equal parts of the whole upon these; the points determined will be the analogous points of the new figure. If, for instance, the hexahedron A F (Fig. 17.) is so much to be reduced, that the edge of the new figure becomes equal to two-fifths of the edge of the original, it will be necessary to draw N A, N B, N C, N D, &c. and to take upon these lines $N A^I = \frac{2}{5} N A$, $N B^I = \frac{2}{5} N B$, $N C^I = \frac{2}{5} N C$, $N D^I = \frac{2}{5} N D$, &c. The hexahedron is now completed by joining these points by the straight lines $A^I B^I$, $B^I D^I$, $D^I C^I$, $C A^I$, &c. In most cases, however, it will be more expeditious to draw the axes, like A F, B E, &c., or other lines, through the centre of the solid, and take upon these the same relative distances $A^{II} M = \frac{2}{5} A M$, &c., which will likewise yield a hexahedron, the side of which is equal to two-fifths of the side of the original form.

XXX. — *Account of some Fishes observed during Capt. FRANKLIN and Dr RICHARDSON'S Journey to the Polar Sea.*

(*Read 24th January 1824.*)

By Dr JOHN RICHARDSON, M. W. S. &c.

THE following zoological notices were originally drawn up, to be inserted in the Appendix to Captain Franklin's Narrative of a Journey to the Polar Sea; but to prevent that part of his work from swelling to an undue size, it was found advisable to exclude them, together with the detailed accounts of all the other species that were not deemed to have been previously undescribed. As the following descriptions, however, were taken from the examination of a great many recent specimens, and as they contain some details which have not hitherto been made public, and relate to species which may not soon come under the inspection of a naturalist, they are respectfully submitted to the Society.

* COREGONUS ALBUS. White Fish.

THIS fish has been long known to the fur-traders by the appellations of *Poisson blanc*, *White Fish*, or *Tittymeg*, the latter corrupted from the word *Attihhawemeg*, the name given to it by the Cree Indians. The Chepewyans and Copper Indians term it *Thlooæh*. It is noticed by Hearne under the name of *Tickomeg*; and Pennant, in Arctic Zoology, perhaps from the imperfection of his specimens, has confounded it with the *Salmo lavaretus* or *Guiniad* of British Zoology †. Very lately M. Le Sueur discovered it in the large lakes which bound the United States to the northward, and, adopting Artedi's genus of *Coregonus*, has described it correctly as a distinct species under the name of *Coregonus albus* ‡. This description, however, being merely intended for identification, is so brief, that I have been induced to record the following particulars, drawn up from the dissection and comparison of many individuals.

Shape.—The body is compressed, and, when viewed laterally, nearly ovate, tapering to form the tail. The back is arched, and in a fat individual very gibbous before the dorsal fin. The depth of a full-grown fish may be stated at one-third of its length; when fat it exceeds, and when lean falls short of, that proportion.

The *lateral line*, running nearly midway between the back and the belly, is arched under the first dorsal, from whence it runs perfectly straight to the caudal fin.

* Genus *Salmo*, Linn.; *Coregonus*, Artedi.—Subgenus *Coregonus*; *Les Ombres*, Cuvier, 'Regne Animale,' vol. xi. p. 162.

† 'Arctic Zoology,' Introd. p. ccxviii. and vol. xi. p. 393.

‡ Le Sueur, 'Journal of the Academy of Sciences, Philadelphia,' vol. i. p. 232, with a figure.

The *colour* is bluish-grey on the back, lighter on the sides, and on the belly white. There are no spots on the body.

The *scales* are orbicular, with an even margin, and rather large, being half an inch in diameter. They are of equal size on the back and belly, and possess a bright pearly lustre. The opercula, cheeks, and irides, have the same lustre with the scales.

The *head* is small, compressed, and ends in an obtuse snout, which appears more pointed when viewed laterally. The infra-orbital bones cover all the cheek. The vertex is clothed with a soft smooth skin.

The *eyes* are large, and the orbit is about one-third nearer to the extremity of the snout than to the posterior margin of the operculum.

The *nostrils* are double, and placed immediately before the anterior superior angle of the orbit. The membranous margin of the anterior opening answers as an operculum to the posterior one.

The *mouth* is small, and when shut its angles are depressed. It is somewhat four-sided when open. The superior and inferior maxillary bones form the principal part of its border; the intermaxillary bones are small, and very thin, and, through the medium of a cartilaginous articulation with the end of the snout, give an obscure motion to the upper lip, which descends obliquely. The maxillaries having a semi-elliptical figure, form the sides of the mouth with their curved edges. They are connected with the intermaxillaries through the medium of membrane, and are articulated with the snout by their rather pointed upper extremities: their lower extremities are rounded, and play upon the lower jaw, being aided in their motions by a small, loose, thin, ovate process. The jaws are of equal

length, and when the mouth is open project beyond the snout.

The *tongue* is cordiform, firm, and armed with extremely minute scattered teeth. There are also a few *teeth* on the jaws, but they are seen with difficulty, and are too slender to be felt. The palate is quite smooth.

The *branchiostegous membranes* are thick, from the quantity of muscle, and a shining membrane, which line their eight flat curved rays, and at their union with each other, on the throat, they form a few plicæ. The rays are narrower and smaller, the nearer they are to the mæstial ventral line. The innermost are very slender. The branchial arches almost encircle the œsophagus, their posterior ends being nearly in contact with each other, at their insertion into the basilar process. Each arch has a single row of erect subulate processes, about one-fourth of an inch long, which are rough on their inner surfaces. There are no pharyngeal bones.

On opening the abdomen, a multitude of cæca present themselves, involved in the folds of a membrane which is generally loaded with fat. This membrane is a production of the peritonæum, and bears a strong resemblance to an omentum. It descends about half-way down the abdomen, and conceals the stomach and liver, being closely attached to the former viscus by numerous vessels. A long spleen is attached to its right border.

The alimentary canal descends from the pharynx for about five inches, in form of a straight wide tube. The lining in this tube is disposed in six longitudinal rugæ, and is of a red colour, except an inch at its commencement, which is white, presents the appearance of a glandular structure, and may be considered as œsophagus. The red part of the tube, which may be named the upper part of the stomach, makes a sudden turn to cross the liver,

and, bending upwards, terminates in what may be denominated the proper stomach. The latter, an uniform sac, $2\frac{1}{2}$ inches in diameter, bears, in its shape, and in the thickness of its coats, a strong resemblance to the gizzard of a fowl, but does not exhibit the same muscular structure. It consists, first, of a thin peritonæal coat,—then of a firm coat, of a clear gelatinous appearance, which forms the principal part of the thickness of its parietes, and when boiled separates into layers: next to this, there is a very firm, almost cartilaginous, layer; and the inner membrane of the whole is of a grey colour, and thick spongy substance, differing in appearance from the lining of the narrow part of the viscus. The rugæ of the œsophagus are continued into the dilated part of the stomach, but from their expansion they become nearly obsolete.

The pylorus is placed in the fundus of the oviform part, where it is nearly in contact with the thoracic septum or diaphragm.

The coats of the *first intestine* are thin, and the internal one exhibits a few longitudinal rugæ. A short way below the pylorus, it is encircled by the cæca, which continue to be inserted into it for about two-thirds of its length downwards. There are about 150 of them, an inch long, of a conical figure, and generally filled with a yellowish mucus. They are too slender to admit the grosser contents of the stomach.

The first intestine ends in a *rectum*. There is no valve at their junction, but the latter is easily distinguished by the well-marked folds of its internal membrane encircling the canal.

The first intestine is in proportion to the length of the body, as 9 to 16; the first and second together, as 12 to 16; and the whole alimentary canal as 19 to 16. These proportions, however, are only approximations, as the

length of the canal was found to vary considerably in different individuals.

The *liver* is small, obtusely triangular, without lobes, and lies over the œsophagus, and behind the cæca, and convolutions of the first intestine. The cystic duct has remarkably thick coats, and terminates in the first intestine, about half an inch below the stomach.

The *air-bladder* is large, extends the whole length of the abdomen, and sends a pretty wide tube into the upper part of the stomach.

The kidneys lie along the spine, the whole length of the air-bladder.

The dorsal fin, placed in the middle of the body, is subquadrangular, diminishing in height as it proceeds backwards. It contains twelve rays, the two first nearly simple, the posterior ones becoming gradually more forked; two small rays support the base of the first one. The adipose fin is acinaciform, or somewhat falcate in shape, with a broad attachment opposite the anal fin. The pectorals have sixteen rays, more or less forked, the interior ones becoming gradually shorter, which gives the fins a somewhat pointed acinaciform appearance. The ventrals, placed opposite the dorsal, are fan-shaped, and have eleven rays, all much forked. The outer ray is supported by a short one. The anal fin has twelve rays, is subquadrangular, higher anteriorly, and leaves a portion of naked tail behind it, equal to the length of its own insertion.

The caudal fin is crescentic: a quadrangular portion at its base is covered with scales. B. 8, P. 16, V. 11, A. 12, D. 12, C. 18 $\frac{6}{8}$ rays. This fish weighs in general about 3 lb., but those of 8 lb. are not uncommon, and they have been known to reach even 20 lb. When very fat, its shape is somewhat distorted, as it acquires a hump immediately behind the head. The very large fish increase

principally in circumference, their length suffering little augmentation. The ordinary length is about 16 or 18 inches.

The Attihhawmegh seems to prey on insects. Its stomach, however, is generally filled with earth, mixed with a few slender roots of vegetables, and some small white worms. It has been known, though rarely, to take a hook baited with a small piece of meat.

Some fine Attihhawmegh were caught at the mouth of the Copper-Mine River, and in Bathurst's Inlet, and they abound in every river and lake in the country. They form a most delicious food, and at many parts are used as the sole article of diet, for years together, without producing satiety. It spawns in the month of October.

We observed no difference in external appearance between the males and females.

* COREGONUS ARTEDI.

Le Sueur, in the Journal of the Academy of Sciences, notices a fish under the name of *Coregonus Artedi*, or *Herring Salmon*, as occurring in the same lakes with *Coregonus albus*. The description there given is not sufficient to enable us absolutely to identify the one we are about to mention with his species, but, at the same time, the coincidences of character and habitat render it unadvisable for us to attempt to describe them as distinct.

Our fish is known to the fur-traders by the name of *Tullibee*, a corruption of its Cree appellation, *Otonneebees*. It bears a very strong resemblance to the *Coregonus*

* Genus *Salmo*, Linn.; *Coregonus*, Artedi.—Subgenus *Coregonus*; *Les Ombres*, Cuvier; *Coregonus Artedi*.—Le Sueur, 'Journal of the Academy of Sciences, Philadelphia,' vol. i. p. 231.

albus, or Attihhawmeg, their general figure, and the shape of their fins being nearly alike. It is, however, a more delicate-looking fish, from the comparative smallness of its organs.

Its body, viewed laterally, is broadly oblong, tapering rather suddenly to form the tail. Its back is straighter than that of the Attihhawmegh, and seldom gibbous. Its depth is one-third of its length. The body is compressed; the belly is obtuse; the back rather more acute; the greatest diameter near the lateral line. The *lateral line* is straight, until it nearly reaches the adipose fin, when it makes a very slight curvature upwards.

The colour of the whole body, when held opposite to the light, is silvery, with much lustre. In the shade, the back is greenish-grey, the belly white, and the sides of intermediate colours. The fins are bluish-grey; the opercula, cheeks, and irides, silvery. The scales are oblong, half an inch long, and of nearly uniform size over the whole body. The vertex is covered with a soft, smooth, bluish-grey skin.

The *head* is small, and, when viewed sideways, appears conical. The snout is short, and, when the jaws are open, appears truncated. In a dried specimen it looks rather pointed.

The *mouth* is smaller; and the lips, when open, project in a still less degree beyond the snout than those of the Attihhawmegh. Its orifice is transverse. The lower jaw is very slightly longer than the upper one, and has a small knob at its symphysis in the male, which is received into a depression, produced in the upper one by the smallness and recession of the intermaxillary bones.

The *teeth* on the jaws, if any, are too small to be felt. The tongue is heart-shaped, soft on the edges; but there is a small plate in its centre set with minute teeth.

The *bronchial arches* are set with solitary rows of long awl-shaped cartilaginous processes, serrated on their inner sides with two rows of minute teeth. The central processes of the upper arch are half an inch long, those on the other arches are smaller.

The œsophagus is short, and distinguished from the stomach by its white colour, and glandular appearance. Its internal membrane forms six large longitudinal rugæ. The stomach descends in a straight line from the œsophagus, for about an inch and a half; it is then bent upon itself, and runs upwards towards the septum, and terminates in the first intestine. The descending portion of the stomach is slender, the ascending part more dilated; both are lined by a continuation of the internal membrane of the œsophagus, and exhibit the same number of rugæ. This membrane is thick, and forms a projecting ring at the pylorus, where it evidently terminates. The ascending portion of the stomach differs remarkably from the same part in the Attihhawmegh, in the comparative thinness of its coats. Beyond the pylorus there is a sac of the same diameter with the fundus of the stomach, and like it directed upwards. It is lined by a firm, somewhat glandular membrane, perforated by the orifices of numerous cæca. At the bottom of this sac, the alimentary canal is again bent upon itself, and runs downwards in a straight line to the anus. In the upper part of this course the canal is slender, with delicate coats, and no rugæ: in the lower part, its diameter becomes greater, and its lining is disposed in circular plicæ, of a bright red colour, similar to the same part of the Attihhawmegh. About an inch of intestine next the anus is smooth, and somewhat dilated. There is no proper valve at the rectum.

There are about 120 cæca inserted into the sac above mentioned, and into the gut a short way below it. The

liver is triangular, with the apex directed downwards, and a small lobe at the upper end. The gall-bladder is large, being nearly half the size of the liver. The gall-bladder is a little dilated at its termination, and terminates in the sac with the cæca. The spleen is long and large. The milt is of a wood-brown colour.

B. 8, P. 16, V. $12\frac{1}{2}$, A. 12, D. $12\frac{1}{2}$, C.

Dimensions of an individual of the ordinary size.

Length, exclusive of caudal fin, - -	14 inches.
_____ from snout to anus, - - - -	$11\frac{1}{2}$
Depth where greatest, - - - - -	$4\frac{1}{2}$
Length of gut from pylorus to anus, -	9
_____ of stomach and œsophagus, - -	$2\frac{1}{2}$
Whole length of intestinal canal, - -	$11\frac{1}{2}$

The habits and food of this fish appear to differ but little from those of the Attihhawmegh, notwithstanding the great difference in the structure of their stomachs. It is inferior to that fish as an article of food, and is comparatively rare.

It is found in most of the lakes, and we caught some very fine ones in the sea at the mouth of the Copper-Mine River.

HIODON CLODALIS. Gold Eye.

The Canadian voyagers have long known this fish by the name of *Naccaysh*, the English fur-traders by that of *Gold Eye*; yet, from its being confined to the inland lakes, it does not appear to have been sent to Forster or Hearne, to whose investigations we owe all that is known respecting the Hudson's Bay fish. Its Cree name is *Oweepeetcheesees*. M. Le Sueur having met with it in the northern parts of the United States, constructed a new generic character*

for its reception,—a distinction which it well merits, as the want of an adipose fin, exclusive of differences in internal structure, keep it separate from the already heterogeneous Linnæan genus *Salmo*; and its organisation renders it equally unfit to unite with *Esox*, the only other genus with which it has any affinity.

Shape.—When viewed laterally, the outline of the fish, exclusive of the tail, is nearly oval, the curvature of the belly being a little greater than that of the back. The tail lies nearer the plane of the back than of the belly, and is much narrower than the body; hence it is connected at the anus with the curve of the belly by a sudden and very considerable slope, the whole of which is occupied by the anal fin. The body is greatly compressed. Its greatest thickness is just above the lateral line, or near the back. The belly has a very acute edge, free from serratures; the back is also acute, but in a less degree.

The *lateral line* lies nearer to the back than to the belly. It continues straight from the operculum till it passes the dorsal fin, when it is slightly deflected.

Colour.—The body has a silvery colour, with much lustre.

The *scales* are irregularly orbicular, and large, being about half an inch in diameter. The membrane that covers their bases has a bluish-grey colour.

The *head* is much compressed, and sideways appears conical, with an obtuse snout. There are no scales on the vertex, but the occiput is covered with a large scale on each side. The irides and sides of the head are tinged with honey-yellow, and have much nacry lustre. The infra-orbital bones have in the aggregate a nearly circular out-

* *Hiodon*, Le Sueur, 'Journal of Academy of Sciences, Philadelphia,' vol. i. p. 367. tab. 14.

line, and cover the whole cheek. The præ-operculum triangular, larger and stronger than the operculum, curves down upon the bronchiostegous membrane, and has a pearly lustre. A narrow, somewhat cartilaginous, border forms the posterior rounded margin of the operculum.

The *eye* is large, and its orbit approaches very near the margin of the mouth.

The *nostrils* are double, and placed above the angle of the eye, near the extremity of the snout. The valve of the posterior nostril is formed out of the membranous border of the anterior one.

The *mouth* is large for the size of the head, and its orifice descends obliquely downwards. When the jaws are extended, the upper one is nearly vertical, forming an angle of 70° with the lower one, which stands horizontally, and consequently appears the longer of the two. The maxillaries enter rather more largely into the composition of the margin of the mouth than the intermaxillaries. Both are narrow: the former linear, nearly immoveable, and articulated with the latter, whose somewhat dilated extremities project a little over the lower jaw, and move slightly forwards when the mouth opens.

Teeth.—The upper jaw is armed with a single row of conical teeth, the intermaxillary ones being considerably the largest. The lower jaw is strong, and armed with a double row of conical teeth, having their points directed backwards. Betwixt these two rows there is a narrow, bony surface, rough, with minute teeth. The vomer projects from the roof of the mouth, and is armed, like the lower jaw, with rows of strong conical teeth, and intermediate card-like plates. The palatine bones are rough, with minute teeth. The largest teeth of all are hook-shaped, and situate upon the margin of the tongue. The centre of the

tongue is covered with small hook-shaped teeth, densely crowded.

The *bronchiostegous membranes* are thick, and the left one overlaps the right at their insertion into the root of the tongue; they contain each nine small cylindrical rays. The gill-openings are large. The bronchial arches are furnished with double rows of club-shaped cartilaginous processes, rough with teeth. The posterior extremities of the arches are connected by soft membrane, the anterior ones by cartilages. At both extremities there are slight plates covered with small teeth.

Intestines.—The œsophagus, an inch long, is distinguished from the stomach by its more delicate and whiter rugæ. The stomach is a long sac, which makes a curve at its fundus. Its internal membrane forms nine or ten large longitudinal rugæ, of a reddish colour. The pylorus is very distinct, being much contracted. The gut is nearly of equal diameter throughout, except immediately below the pylorus, where it is dilated. Into this dilated part the gall-duct opens on the one side, and a short, wide, obtuse cæcum on the other. This solitary cæcum is three-fourths of an inch long. The internal membrane of the gut is soft and villous, without regular rugæ or plicæ. There is no distinct rectum. The intestines make one convolution. The fæces have a honey-yellow colour. The liver is linguæ-form, lies on the right side, with a small lobe on the left, and has a reddish-orange colour. There are two small spleens. The *air-bladder* is capacious, and communicates with the œsophagus. The kidneys are thickly spotted with dark-brown specks on a bluish-grey ground. The lining of the abdomen is of a pearly colour, the roe of a pure white.

Fins.—The *dorsal fin*, placed where the back slopes down to form the tail, and beginning opposite to the com.

mencement of the anal fin, is somewhat quadrangular, more elevated, however, anteriorly. It contains eleven rays, the first of which is short and simple; the second, which is the tallest in the fin, is also simple; the rest become gradually more forked and shorter as they recede backwards; the last is divided nearly to the base. The *pectorals* are somewhat pointed, and have twelve rays, of which the first is longer and stronger than the others, the posterior ones becoming gradually smaller. The *ventrals* somewhat fan-shaped, and of a moderate size, have seven forked rays. The *anal fin* is long, and occupies the long slope which the tail forms to unite with the belly at the anus. It becomes gradually narrower posteriorly, has a slightly waved margin, and contains thirty-four rays, of which the first is short, and covers the base of the second, which is the longest in the fin. They are all, except the first, more or less forked. The caudal fin is crescentic: the lower lobe rather larger than the upper one. It contains eighteen rays, the base of the outer ones supported on each side by six or seven smaller ones.

P. 12, D. 11, A. 34, V. 7, C. 18 $\frac{1}{2}$.

Dimensions of an individual.

Length, exclusive of the caudal fin, - 14 inches.

——— to anus, - - - - - 9

Depth, - - - - - 4 $\frac{3}{4}$

This fish resembles the small trouts in its habits. It is caught at Cumberland House only in the spring. The specimens we saw there agree very well in general with the figure of Le Sueur above quoted, but the tail of his specimens appears to have been more forked, the mouth does not droop so much, and section, Fig. 2. is much more obtuse, both above and below, than in ours. In the Owee-pectcheeses the belly is much compressed, and very acute.

XXXI.—*Observations on the Habits, Appearance, and Anatomical Structure of the Bird named The Trumpeter, Psophia crepitans of LINNÆUS, Agami of CUVIER.*

By THOMAS STEWART TRAIL, M. D. F. R. S. E.
M. W. S. &c.

(Read 12th November 1825.)

A LIVING specimen of this singular bird having been sent from Demerara by my friend Charles S. Parker *junior*, Esq., a zealous and accomplished naturalist, I had a favourable opportunity, in the summer of 1824, of noticing its habits. An accident which caused its death soon enabled me to examine its internal structure; and I detected so remarkable a peculiarity in the formation of its bronchial tubes, that I laid an account of it before the Literary and Philosophical Society of Liverpool, at the first meeting in October. Unwilling, however, to publish an account of this remarkable structure from a single dissection, I wrote to a young friend in Demerara to procure living specimens of the bird, and two were lately sent to me from that colony. Of these one died on the passage, and was immediately put into a small cask with rum; the other lived until the ship arrived, but died on that day, and was examined.

a few hours after death. The most careful dissection of the organs of respiration in both birds, in which I was assisted by Dr Williams, completely confirmed the discovery which I had made, a year ago, of the *direct* communication between the trachea and great air-cells in the Trumpeter. This structure I shall fully explain, after a few remarks on the general appearance of the living bird.

The external appearance differs little from the concise descriptions given by Latham and Cuvier; but Latham's figure represents the bird much too erect; for it usually carried its neck arched below, and its shoulders elevated above the bend of the neck, something in the manner of a heron.

In the first specimen examined, I found the beak of a deep-brown colour, and the upper mandible a little shorter than the lower; but this was evidently the effect of a hurt it had received some time before. The beaks of the other two specimens were dark-brown, streaked with deep-green. The upper mandible projected beyond the lower about $\frac{1}{8}$ th of an inch; it was arched and pointed, but the extremity was a little rounded, though with sharp edges. The nostrils are large, oval, pervious, and slightly covered above and behind by a blackish membrane. The eye is large, and of a clear bluish-black colour. Dr Latham describes the iris as of a luteous-brown, but in my specimens it was not so; the iris, in the living and in the recently dead bird, being with difficulty distinguishable from the pupil.

The shield of brilliant feathers on the breast was conspicuous in them all, though two were females; but the colour had more of the iridescent hues of tempered steel than of the golden tint described by some authors. The feathers of the head and neck are velvet-black, soft and curled; the feathers on the shoulders, and breast below the shield, are long, slender, and more coarse. The scapulars

descend considerably on the back, and near their extremities partake of that rufous ash colour which has been by some ornithologists termed *testaceous*.

The wings are short and concave. The spurious wing has four stout feathers. The primaries are 14, of a deep-brown colour, with blackish shafts; but they are nearly equalled by the ten secondary feathers, which are of a fine ash-grey, and, folding over the upper parts of the bird, give its back and rump this colour, when the wings are closed. The wing covers are black.

The tail is short, consisting of ten black feathers, the longest of which do not exceed four inches.

The feathers on the back, rump, and whole under parts of the bird, are black, long and narrow. The feathers descend on the legs to within $1\frac{1}{2}$ inch of the tarsal joint, commonly called the knee of a bird.

The tarsus is long and slender; and the bone, though strong, breaks into many fragments when fractured. The legs and feet are covered by a dense skin, of a fine apple-green colour. The hind part of the tarsus is protected by large scales, which are clouded with deep brown spots. The inner toe is connected to the middle one, by a strong membrane extending to the first joint. The hind toe is rather small. The claws are blackish, incurved, compressed, and sharp; the middle one, which, measured along its curvature, is fully half an inch in length, is slightly grooved on the inside of its lower surface, and has a sharp edge.

The social habits of this bird made the living specimen a favourite with its owner. It often accompanied the different members of the family in their walks; and, if any one attempted to avoid it by running, it speedily overtook the fugitive, aiding the action of its long legs by flapping its wings. It would eat from the hand, and readily fed on bread, boiled potatoes, or seeds; but it seemed most eager

in its search after insects and worms. This occupation it pursued with such intensity, while the gardener was turning up the soil, as sometimes to endanger its head from the stroke of the spade. It delighted to wade in pools of water; and was often observed to plunge its head below the surface, seemingly in quest of prey.

Latham has placed the *Psophia* among the *Gallinacei*; but Cuvier, with greater propriety, has included it in his order of *Echassiers*, the *Grallæ* of Linnæus; to which the habits of the bird, and its external form (with the exception of its head), are more analogous. This idea acquires further confirmation from the very little fat between the skin and muscles of this bird, as well as the extreme difficulty I found in separating them. In all my specimens, though apparently healthy, there was no fat to be seen between the skin and muscles, except a very little about the rump; yet in two of them there was a considerable accumulation of fat among the intestines, shewing that they were not emaciated.

The gullet of the *Psophia* is strongly muscular; its gizzard small, muscular, and, when recent, its internal coat is rugous, and is lined with a grass-green viscid fluid. The liver is large, covering the greatest part of the other viscera. The intestines are cylindrical, and nearly equal the narrowest part of the gullet in diameter; the cloaca is but slightly dilated. The coats of the intestines are thick and strong; they come off at right angles from the middle of the right side of the gizzard. In the two females the oviducts were short; the ovaries distinct, but not developed.

The transparent partitions of the great air-cells are remarkably tough in this bird, and communicate with each other in the usual manner. The external surfaces of the lungs are perforated by holes visible to the naked eye, and pervious to air.

The very peculiar cry of this bird has long been known to naturalists. When caressed, the living individual, from which this description is taken, uttered a deep basso sound, which may be tolerably represented by the syllables *ouï, ouï, ouï*, and which seemed to proceed from the interior of its body. This cry was occasionally preceded by a shriller note, which appeared to proceed from the mouth; but it was almost always followed by the deep internal sound above mentioned, that may be considered as the ordinary voice of the bird. During its emission, the mandibles were slightly separated, and the muscles of the belly were observed to be thrown into strong action, though without any convulsive effort.

It can only be from inattention that any naturalist could describe the sounds as emitted *per anum*, an idea from which the bird has derived its absurd trivial name. This appellation I would propose to change for a more suitable name, viz. *Psophia loricata*, or *P. clypeata*, in allusion to the breastplate or shield of beautiful feathers, so conspicuous on this bird. The voice is formed within the body, and seems to proceed from its interior; so that the *Psophia* may be considered as a true *ventriloquist*.

Though the extraordinary sounds emitted by the Trumpeter have attracted notice, I am not aware that any anatomist has hitherto investigated the structure of its organs of voice. I therefore readily availed myself of the first opportunity of examining its internal structure, and have found my first observations confirmed, after the interval of a year, by two other dissections.

On carefully dividing the ribs, and raising up the sternum, the respiratory organs were exposed to view; and I soon perceived that the bronchial tubes, instead of being united all round to the lower end of the trachea, so as to form with it continuous tubes, had each a considerable

aperture on their approximate sides; which opening communicated directly with the great air-cells of the cavity containing the heart and other viscera of the bird.

This deviation from the usual structure is not very obvious to the eye, until the attachment of one of the bronchial tubes to the lungs is divided, and turned back; when the *septum* of the lower end of the trachea is distinctly seen, fringed with a firm but delicate membrane, which is quite separated from that forming the approximate sides of the bronchial tubes; and a probe can be at once passed into the bronchial tubes, without the rupture of any membrane. In dissecting the recent specimen, on 6th August 1825, when the lungs and bronchial tubes were still *in situ*, and merely exposed to view, I placed the whole under the surface of water; and on blowing into the trachea, the air was seen to pass through these openings on the inner sides of the bronchial tubes. A fine bristle, blunted at the extremity by burning, was introduced into these openings, and afterwards they were found sufficient to admit a large silver probe. On 13th August the specimen preserved in spirits was carefully opened, in the presence of Dr Williams, in a somewhat different manner. After exposing the inside of the thorax, the heart was dissected away, and the bronchial tubes remained in their natural situation. We found a small cell freely communicating with the great air-cells, formed by a transparent membrane stretched over the bronchial tubes; while through it we could distinctly perceive the patulous openings in the bronchial tubes, kept distended by the rings of these tubes, so as to receive a portion of either air or water passing from the trachea; as we ascertained by placing the whole in a basin with water.

It would not be easy to represent in a drawing these apertures in the natural position of the bronchial tubes; but their appearance, when the tubes and trachea are in-

Fig. 7.

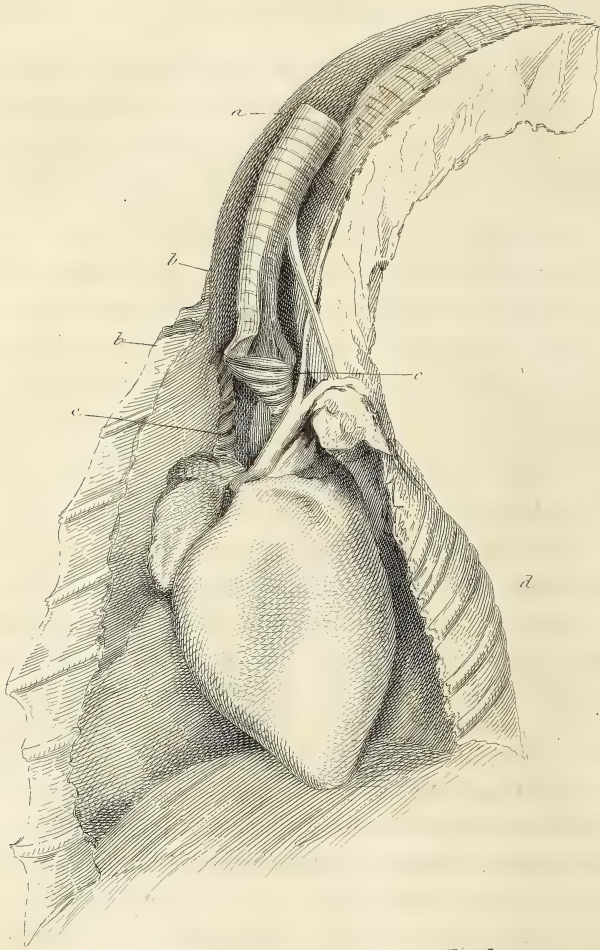

Fig. 2.

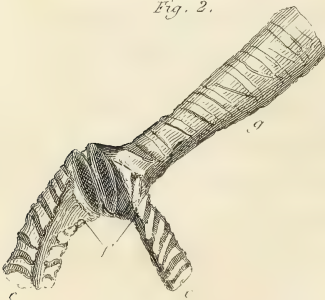
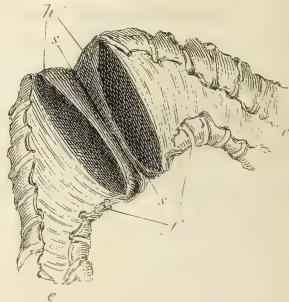

Fig. 3.



verted, is shewn at Fig. 2., and still better at Fig. 3. Plate XVI. The drawing, Fig. 1., is of the size of nature; the parts are seen in their true position, having been taken while the subject was recent, and before the tubes were displaced.

The glottis or upper larynx of the Trumpeter presents nothing remarkable. The general form of the trachea is conical,—a shape (as remarked by Cuvier in his admirable Dissertation on the Voice of Birds) which is usually the index of an unmusical voice; whereas the cylindrical trachea belongs to songsters, and other birds possessing what he calls *une voix flutée*. The windpipe of the Trumpeter is very slightly dilated, about an inch before it enters the thorax, when it contracts a little, and rather suddenly. Each ring, when closely examined, consists of two cartilages joined firmly together at the sides of the trachea,—a structure not readily detected, until the windpipe has been macerated in water for some time. The rings are firm, and lie close to each other; yet the trachea is capable of considerable elongation, from the simultaneous action of the *mylo-hyoideus*, *sterno-trachealis*, and *upsilo-trachealis* muscles. On emerging from the thorax, the trachea first passes along the front, and then to the right side of the lower curvature of the neck, for about four inches; when it again stretches toward the forepart of the neck, before it reaches the head of the bird.

The lowest cartilage of the trachea is firm, almost bony; its lateral portions have an obtuse triangular form, with minute projections at the extremities, where they meet the bony septum of the lower larynx. This septum is thin, and about $\frac{1}{20}$ th of an inch in depth, dividing the extremity of the air-tube into two acutely oval foramina, rather more than 0.3 inch in length, and 0.1 inch in their greatest diameter. Each side of the septum supports a thin, strong, membranous plate or fringe, about 0.1 inch in breadth,

which appears to be a continuation of the membrane lining the trachea; but which is quite divided from the membrane forming the approximate sides of the bronchial tubes*. The bronchial tubes have slender cartilages, that do not extend more than two-thirds around their circumference, even at their upper extremity. The approximate side of each tube, as is usually the case in birds, consists of a thin membrane, which is named by Cuvier *membrane tympaniforme*; but in the *Psophia* it can scarcely deserve that appellation, for, instead of uniting the trachea and bronchial tubes into continuous canals, as in other birds, the upper edge of the membrane forming the bronchial tubes is not continued to the end of the trachea, but allows an opening into each tube, sufficient to admit with ease a common probe,—by which a portion of the air passing from the trachea can find its way into the great air-cells, without previously passing through the lungs. The elasticity of the bronchial cartilages is sufficient to keep these openings so distended, that air at the same time passes into the lungs through the bronchial tubes: as may be seen in the preparation I have made of one of the birds.

It seems probable, from a consideration of the structure of the organs of voice and respiration in the Trumpeter, that the living bird has the power of regulating, in some degree, the relative quantity of air which shall pass in either direction, by the action of the *sterno-trachealis* and *upsilo-trachealis* muscles, aided by the contractility of a very minute pair of muscles (represented in Fig. 1. *b, b*), arising from the lower rings of the trachea, and inserted into the

* I may remark, that the whole lower larynx of the Trumpeter, with the exception of the apertures in the bronchial tubes, has a striking resemblance to the corresponding organs in the Whimbrel, *Scolopax phæopus*, a specimen of which I dissected about the same time as the first Trumpeter.

upper cartilage of the bronchial tubes. The bronchial tubes perforate the lungs in the usual manner; and the surface of the lungs exhibits to the eye numerous small perforations communicating with the great air-cells.

The extraordinary structure of the lower larynx in the *Psophia*, cannot fail to have much influence on its voice. The excellent description which Cuvier has given of the mechanism of the organs of voice in birds, and his very decisive experiments, leave it not doubtful that the lower larynx is the organ by which the sound is *produced*, although the modifications of its tone are influenced by the length and form of the trachea, and the contractions and dilatations of the upper larynx. The lower larynx may be considered, in relation to the organs of voice in birds, as the mouth-piece to the clarinet or flageolet,—the part where the sounds are *formed*; while the elongation of the trachea, or the contraction of the rima glottidis, merely vary the *intensity of the intonation*; just as lengthening a flute, by means of its sliding joint, deepens its tone; or as the hand of the player introduced into the expanded extremity of a French horn, affects the tension of the notes of that instrument.

In the bird now under consideration, the division of the aërial current must weaken its force, and the vibrations of the membranes of the lower larynx will therefore be less quickly performed, and, consequently, the voice of the bird reduced to a lower key, than if the current of air had acted in an undivided stream.

The ventriloquism of the *Psophia* appeared to me to be performed during *inspiration*; and it has been alleged, that persons who have acquired this curious faculty, utter their words during the act of receiving air into the lungs, whenever they wish to exhibit their art. The powerful

action of the muscles of the bird, when it uttered its peculiar cry, rendered it very difficult to ascertain this point with certainty; but it is not difficult to conceive how the voice, formed deeply within the body, would be materially affected by the direct communication of the windpipe with the great air-cells of this singular bird.



Description of the Drawing, Plate XVI.

Fig. 1. Opened thorax of the Trumpeter, of the natural size.

a, Dilated portion of the trachea.

b, b, A small muscle tending to draw up the bronchial tubes.

c, c, The bronchial tubes.

d, The heart *in situ*.

2. The inverted trachea and bronchial tubes, shewing the openings into the bronchial tubes.

3. Magnified view of the two bronchial tubes, *e, e*.

f, The membrane forming their approximate sides.

s, s, The bony septum dividing the lower part of the trachea.

h, The membranous plates which fringe the sides of the septum.

LIVERPOOL, }
August 13. 1825. }

XXXII.—*Memoir on the Classification and Division of Gnaphalium and Xeranthemum of LINNÆUS.*

By Mr DAVID DON,

Librarian to the Linnean Society, &c. &c.

IT must be admitted, that, notwithstanding the highly important labours of Brown, Cassini, Decandolle, and Kunth, much still remains to be done in the class of plants denominated *Compositæ*. In extensive genera, it very frequently happens, that numbers of species are included, having little affinity with those on which the genera were founded. This is eminently the case with *Gnaphalium* and *Xeranthemum*. We are not to be surprised, if our great master, LINNÆUS, has fallen sometimes into this error, —if we consider the scanty materials he had to work on, often being obliged to have recourse to figures, and these not the most faithful; but there is no reason why botanists should still continue these unnatural arrangements. The characters given by Linnæus himself of *Gnaphalium* and *Xeranthemum* will be found to apply to a few only of the species which have been referred to these two genera.

The adoption by Willdenow of the genus *Elichrysum* of Tournefort, so far from lessening, only served to increase the confusion previously existing. Willdenow assumed, as the basis of his genus, an erroneous character, namely, "*receptaculum nudum*," which can only refer to a very small portion of his *Elichrysa*. Our distinguished countryman Mr Brown was the first to attempt a proper limitation of these genera, in a paper entitled, "Observations on the natural Family of Plants called *Compositæ*," inserted in the 12th volume of the Transactions of the Linnean Society. The reading of this admirable paper first led me to an examination of these genera, and the divisions I shall have to propose in the sequel, are the result of that investigation; but convinced that the subject is not yet exhausted, I give some of these divisions, with considerable diffidence, and I shall feel happy, if such of my botanical readers as possess the opportunities, will extend the research, and confirm the observations which I have made.

Before entering on the particular subject of this memoir, it will be perhaps advantageous to give some remarks illustrative of *Compositæ* in general. The *Compositæ* of all known families of plants are the most natural, and the most extensively distributed over the surface of the globe. In the Flora of almost every country, whether situate without or within the Tropics, they are found to constitute nearly a tenth of the Phænogamous Vegetation*. From this extensive distribution of the *Compositæ* has resulted the apparent necessity of dividing them into divers separate groups or families; and hence we find in the writings of the earliest systematic botanists, from Cæsalpinus down to the present time, that various attempts have been made to divide them.

* In tropical countries possessing great diversity of surface, such, for example, as South America, the proportion is considerably greater.

Even a superficial observer cannot but be struck with the apparent discrepancies between certain groups of the *Compositæ*; but let him examine these groups in detail, and these differences at once vanish: for in no class is a uniform chain of natural affinities so beautifully exemplified as in the *Compositæ*. Here we observe no breaks in the series of natural affinities. If interruptions, therefore, in the chain of affinities exist, and we know they do exist in other families, they are not to be found in this, where the various groups are so intimately connected, so blended together at their extremities, that it is next to impossible to define their limits. This is universally the case in all truly natural families. The more a family becomes known, the more difficulty attends its separation into groups.

The end of all divisions in extensive families being practical utility, it is not merely necessary to group together the various genera according to their respective affinities to a particular genus, which is assumed as the type of each separate group; but it is likewise necessary, in order to render such divisions subservient to practical use, that each group be limited by certain characters peculiar to each. Keeping this in view, therefore, we observe that, whatever divisions are adopted in the *Compositæ*, they can only, strictly speaking, be regarded as merely artificial. The important labours of M. Henri Cassini have thrown great light on this class of plants. If this distinguished botanist has erred, it is in forming too many divisions, and in separating genera, which nature evidently intended should not be disjoined. That *Gnaphalium*, which M. Cassini has placed among his *Inuleæ*, and *Xeranthemum*, of which the same distinguished botanist has constituted a distinct group, named by him *Xeranthemeæ*, possess all the essential characters of the *Carduaceæ*, must be evident to every one who has turned his attention to the subject. All of them possess tubular florets, bicaudate anthers,

alternate leaves, and a large proportion of them have a paleaceous receptacle, and the rays of the pappus connected at the base,—all of which appear incontestibly to prove that they cannot with propriety be removed from the *Carduaceæ*; but it is, however, to be observed, that the latter have the tube of their florets suddenly contracted from near the middle downwards; while in *Gnaphalium* and *Helichrysum*, and in the other genera which have been separated from them, the tube of the florets is nearly equal, or gradually narrowed downwards from the summit to the base, as in the *Carlinaeæ* of M. Cassini. This character, although perhaps of generic importance, cannot be assumed as the foundation of a separate group, being liable to considerable variation. Thus, for example, *Cnicus Acarna*, *Carduus cernuus**, *Carthamus tinctorius*, and *Carduus uniflorus*, agree with the *Carlinaeæ* in the form of their florets; and in *Cnicus serratuloides*, *Carduus cyanoides* and *palustris*, the contraction of the tube is scarcely perceptible. In *Xeranthemum* and *Chardinia* the tube of the florets is widened towards the base, and contracted upwards. Had the form and structure of the stigmas in *Helichrysum*, *Gnaphalium*, &c. been uniformly constant, they would have assisted materially in distinguishing them as a separate group. The genus *Carlina* agrees in its stigma with *Xeranthemum*, and with *Astelma* of Brown, in having the rays of its feathery seed-crown united into bundles for a considerable way above the base. The similarity of the pappus of *Acarna* to that of *Metalasia*, is equally striking. In *Carlina acaulis* and *simplex*, as well as in *Atractylis gummifera*, which really belongs to *Carlina*, the rays of the pappus are so remarkably thickened at their extremi-

* This plant M. Cassini has constituted into a genus, named by him *Alfredia*, and has arranged it among the *Carlinaeæ*.

ties, that they might readily be mistaken for the stigmas, which are far less conspicuous. This is also the case with the *Carlina echinus*, the *Echinus mutans* of Cassini; but in it the rays of the pappus are unconnected at the base, and the figure of the florets, as in *Cnicus*, *Carduus*, &c. In the *Carlina vulgaris* and *corymbosa*, the rays of the pappus end in a naked thorny point. The *Inuleæ* of M. Cassini, limited to *Inula* and *Coryza*, will possess sufficient marks in their herbaceous involucre, and in having ligulate florets in the ray, to keep them distinct. *Bupthalmum*, referred by M. Cassini to *Inuleæ*, belongs to the *Heliantheæ*, and *Carpesium* to the *Anthemoideæ*.

We have seen, therefore, the intimate affinity that exists between the true *Carduaceæ* and the plants referred to *Gnaphalium* and *Xeranthemum* of Linnæus. In comparing the *Eupatoreæ* of Cassini, to which the *Vernoniaceæ* of the same distinguished botanist must be reduced, with the *Carduaceæ*, we shall find the affinity almost equally intimate. The former group differs from the latter in the absence of setæ at the base of the anthers. In *Liatris* and *Pteronia*, which belong to the *Eupatoreæ*, the involucre is analogous, especially in *Liatris elegans*, where it is furnished with long, lanceolate, acute, purple rays, like those of *Xeranthemum*. In *Liatris* also, the rays of the feathered seed-crown are united at the base; and both it and *Pteronia* have lanceolate stigmas analogous to those of some species of *Serratula*. If we turn our investigation to the *Labiatifloræ*, we shall meet with similar results. Let us compare, for example, *Xeranthemum*, in which the marginal florets are evidently bilabiate, the anthers bicaudate at the base, and we shall find how closely these characters bring it to the *Labiatifloræ* *. The genus *Catananche*, which belongs

* In some of the normal group of *Carduaceæ*, we find the limb of the florets irregular,—and in *Carduus Marianus*, the genus *Silybum* of Mænoch, it is evidently bilabiate.

undoubtedly to the *Cichoraceæ*, agrees in every respect, both in habit and character, with *Xeranthemum*, except in the florets being all ligulate. The anthers, although not bicaudate at the base, cannot be regarded as entirely naked, being furnished with two small teeth. This is more distinctly observable in *Scolymus*, which, although belonging to the *Cichoraceæ*, has the habit of *Carlina*. The genus *Xeranthemum*, therefore, brings these three groups close to each other, as it were, at right angles.

Although divisions in the extensive class of *Compositæ* are absolutely necessary, in order to facilitate a knowledge of the genera of which it is composed, yet, by the foregoing remarks, I have endeavoured, and I trust satisfactorily, to shew that these divisions are to be regarded in no other light than as artificial; but although artificial, we must avoid the unnatural division of genera. Reserving to a future time the observations I have to make on the other groups of *Compositæ*, I shall now proceed to give characters of the genera I have to propose, adding at the end of each such remarks in elucidation as may appear necessary.

XERANTHEMUM, *Gærtn. Desf.*

XERANTHEMI sp. *Linn. Willd.*

Involucrum imbricatum, scariosum, coloratum; *squamis interioribus* simplici serie longè radiatis. *Receptaculum* planum: *paleis* distinctis, crebris, ensiformibus. *Flosculi hermaphroditi* tubulosi, 5-dentati basi dilatata coriaceâ; *feminei* paucissimi in ambitu, tubo coriaceo, 5-fidi, bilabiati; *labio exteriori* bipartito, brevior. *Filamenta* omnino libera. *Antheræ* basi setis 2 plumosis instructæ. *Stigma* clavatum, emarginatum. *Achenia* oblonga, tereti-angulata, sericea; *flosculis femineis* glabra, apice calva. *Pappus* hermaphroditis hexaphyllus, paleaceus: *paleis* distinctis, ex ovata basi cuspidatis, serrulatis.

Herbæ (Europææ) *erecta, ramosa, niveo-lanata, radice*

annuâ. Folia alterna, lanceolata, integerrima, uninervia. Flores solitarii, pedunculati, magni, albi v. rosei. Stigma flosculis fœmineis integrum, longè exsertum.

To this genus belong *Xeranthemum annuum* and *inapertum* of Willdenow, considered by Linnæus as varieties of one and the same species.

Although I have for the present followed the former, in regarding these as distinct, yet I am very much inclined to believe that they will be found to resolve into a single species. I have already pointed out the numerous points of agreement between this genus and *Catananche*, and that the stigma has a striking analogy to the same organ in *Carlina*, a circumstance which has been before observed by M. Cassini *. The tube of the florets in the *Carduaceæ* is in general of an uniform consistence; but in this and the following genus, the lower half of the tube is of a green colour, thick and coriaceous, and the upper half thin, and of a white colour. M. Desfontaines, although he notices it in *Chardinia*, does not seem to have been aware of its existence in this genus. Although apparently a character of considerable importance, M. Cassini does not notice it in his character of the tribe *Xeranthemææ*.

CHARDINIA, Desf.

XERANTHEMI sp. Willd.

Involucrum imbricatum, scariosum, coloratum, non radians. Receptaculum planum: paleis distinctis, crebris, ensiformibus. Flosculi hermaphroditi tubulosi, 5-dentati: tubus ferè æqualis, ultra dimidium coriaceus; fœminei marginales, filiformes, tridentati. Filamenta parte coriaccâ tubi connata, ultrâ eam libera ac monadelphæ. Antheræ basi setis 2 plumosis instructæ. Stigma clavatum, bilobum.

* Journ. Phys. 82. p. 127.

Achenia difformia; flosculis hermaphroditis oblonga, teretia, sulcata, paleis pluribus (9-10) lanceolatis cuspidatis coronata; fœmineis obcordata, trialata, alis serratis mucronatis.

Herba (Orientalis) lanata, ramosa, radice annuâ. Folia sparsa, elliptica, dentata. Flores magni, solitarii, pedunculati, albi.

This genus consists of but a solitary species, namely, *C. Xeranthemoides* of Desfontaines, the *Xeranthemum orientale* of Willdenow, and the *Xeranthemum orientale, fructu maximo* of Tournefort. So little was it known to Linnæus, that he did not even allow it the rank of a species, being his variety γ of *Xeranthemum annuum*. Although these two genera have many points in common, yet they severally possess abundant characters to keep them distinct. The rayless involucre, the form of the female florets and seeds, the stamens being united to the tube of the florets, and the polyphyllous pappus, are the distinguishing features of *Chardinia*. The genus was established by M. Desfontaines, who has given a very clear and satisfactory account of it, as well as of *Xeranthemum*, in the third volume of the "Memoires du Muséum d'Histoire Naturelle." The name is intended to commemorate the famous Chardin, celebrated for his travels in Persia; and therefore the old specific appellation *orientale* ought to be adopted, in preference to the one proposed by M. Desfontaines. The plant is a native of Armenia.

LEUCOSTEMMA.

ELICHRYSI sp. *Gærtn. Willd.*

XERANTHEMI sp. *Linn.*

Involucrem globosum, imbricatum, scariosum, coloratum: *squamis* omnibus subæqualibus, lanceolatis, acutis,

longè radiantibus. *Receptaculum* hemisphæricum: *paleis* distinctis, lanceolatis, mucronatis, crebris. *Flosculi* omnes hermaphroditi, tubulosi, 5-dentati. *Antheræ* setis 2 plumosis basi instructæ. *Stigma* bipartitum: *laciniis* linearibus, medio canaliculatis, apicè incrassatis truncatisque. *Achenia* tetragona, papilloso-micantia. *Pappus* radiis capillaceis, basi in anulum connexis, apicè incrassatis, denticulatis.

Frutices (Africæ australis) *densè niveo-lanati*. Folia *alterna*, coriacea, *marginata*, *sessilia*. Pedunculi *squamis scariosis niveis illarum involucris instar instructi*. Flores *terminales, solitarii, magni, speciosi, papyracei, nitidi*.

1. *L. vestitum*, foliis linearibus acutis.

Xeranthemum vestitum, Linn. Sp. Pl. 1201.

Gnaphalium vestitum, Thunb. Prod. 148.

Elichrysum vestitum, Willd. Sp. Pl. 3. p. 1903.

Hab. in Promontorio Bonæ Spei. *Thunberg, Masson, Labillardiere, Niven.* h. (v. v. c. et s. sp. in Herb. Lamb.)

2. *L. lingulatum*, foliis lingulatis obtusis.

Hab. in Promontorio Bonæ Spei. *Labillardiere.* h. (v. s. sp. in Herb. Lamb.)

Præcedenti affine, at foliis triplò latioribus differt.

This beautiful and very distinct genus agrees with the two preceding genera, in having the receptacle thickly beset with lanceolate, distinct, pointed paleæ; but its capillary pappus, its parted stigma, and the uniformity and texture of its florets, distinguish it essentially from both. The brilliant white heads of flowers has suggested the name of *Leucostemma*, which I have applied to the genus. It is derived from *λευκος*, *albus*, and *στεμμα*, *corona*.

ASTELMA, *Brown*.

GNAPHALII et XERANTHEMI sp. *Linn*.

ELICHRYSI sp. *Willd*.

Involucrum imbricatum, scariosum, coloratum, connivens v. radians. *Receptaculum* convexum, favosum v. subpaleatum. *Flosculi* omnes hermaphroditi, tubulosi, 5-dentati. *Antheræ* basi biplumatae. *Stigma* bipartitum: *laciniis* lineari-lingulatis, obtusis. *Pappus* radiis plumosis, infernè connatis.

Frutices (Africæ australis) *densè niveo-lanati*. Folia *alterna, sessilia, integerrima, plana*. Flores *terminales, solitarii v. corymbosi, magni, speciosi, nivei v. purpureo-coccinei, aut aurei*.

* *Involucris conniventibus*.

1. *A. eximium*, foliis ovatis acutis, corymbo simplici multifloro, involucris globosis: *squamis* ovalibus obtusissimis.

Astelma eximium, Brown in Bot. Reg. t. 532.

Gnaphalium eximium, Linn. Mant. 573.—Willd. Sp. Pl. 3. p. 1849.

Hab. in Promontorio Bonæ Spei. *Edmundus Lambert, Niven, Joannes Roxburgh*. h. (v. v. c. et s. sp. in Herb. Lamb.)

Involucra globosa, purpureo-coccinea, nitida. *Receptaculum* favosum.

This plant, Mr Lambert informs me, flowered for the first time in England, at Mr Lee's, Hammersmith, in the year 1794.

2. *A. milleflorum*, foliis ovato-lanceolatis mucronatis, corymbis compositis patentissimis, involucris oblongis: *squamis* oblongis apice rotundatis.

Gnaphalium milleflorum, Linn. Suppl. 362. — Thunb. Prod. 152. — Willd. Sp. Pl. 3. p. 1860.

Hab. in planitie aridâ, ad ripas fluminis magni, in Promontorio Bonæ Spei. *Thunberg, Niven.* h. (v. s. sp. in Herb. Lamb.)

Planta 3-6-pedalis, ramosa, densè niveo-lanata. *Corymbus* amplus, indefinitè multiflorus. *Involucra* oblonga, nivea. *Receptaculum* maximè favosum.

3. *A. Stæhelina*, foliis lanceolatis basi attenuatis niveotomentosis, pedunculis elongatis solitariis nudiusculis, involucri squamis ellipticis obtusis.

Xeranthemum Stæhelina, Linn. Syst. Veg. 624.—*Thunb. Prod.* 153.
Elichrysum Stæhelina, Willd. Sp. Pl. 3. p. 1910.

Hab. in Promontorio Bonæ Spei. *Thunberg, Labillardiere, Joannes Roxburgh.* h. (v. s. sp. in Herb. Lamb.)

Involucra oblonga, aurea. *Receptaculum* subpaleatum.

4. *A. crassifolium*, foliis ellipticis basi dilatatis niveotomentosis, pedunculis elongatis solitariis nudiusculis, involucri squamis rotundatis.

Hab. in Promontorio Bonæ Spei. *Niven, Joannes Roxburgh.* h. (v. s. sp. in Herb. Lamb.)

Præcedenti affine. *Receptaculum* etiam subpaleatum.

** *Involucris radiatis.*

5. *A. proteoides*, foliis lanceolatis uninerviis, floribus solitariis sessilibus, involucri squamis ovato-lanceolatis acutis.

Hab. in Promontorio Bonæ Spei. *Joannes Roxburgh.* h. (v. s. sp. in Herb. Lamb.)

Frutex facie omninò *Proteæ* v. *Leucadendri*, densè niveo-lanatus. *Folia* bi- v. tripollicaria. *Flores* magni, nivei

6. *A. speciosissimum*, foliis lanceolatis subtrinerviis, pedunculis elongatis solitariis nudiusculis, involucri squamis ovato-lanceolatis acuminatis.

Xeranthemum speciosissimum, Linn. Sp. Pl. 1202.—Thunb. Prod. 153.
Elichrysum speciosissimum, Willd. Sp. Pl. 3, p. 1904.

Hab. in Montis Tabularii locis glareosis ad Promontorium Bonæ Spei. *Thunberg, Menzies, Niven, Joannes Roxburgh.* h. (v. v. c. et s. sp. in Herb. Lamb.)

Flores maximi, nivei.

7. *A. lineare*, foliis linearibus uninerviis utrinque lutescente-lanatis, pedunculis elongatis solitariis nudiusculis, involucri squamis ovato-lanceolatis acutis.

Hab. ad Promontorium Bonæ Spei. *Joannes Roxburgh.* h. (v. s. sp. in Herb. Lamb.)

Præcedenti affine. *Flores* minores, nivei.

8. *A. variegatum*, foliis lanceolatis acutis carinatis laxissimè imbricatis sæpiùsque tortis margine apiceque rufis, pedunculis solitariis, involucri squamis oblongis obtusis apice extùs atro-sanguineis.

Xeranthemum variegatum, Linn. Syst. Veg. 624.—Thunb. Prod. 153.
Elichrysum variegatum, Willd. Sp. Pl. 3, p. 1911.

β spirale, floribus majoribus.

Elichrysum spirale, Andrew's Rep. t. 262.—Willd. Sp. Pl. 3, p. 1903.

Hab. in planitie sterili prope Caput Bonæ Spei. *Menzies, Niven, Joannes Roxburgh.* h. (v. v. c. et s. sp. in Herb. Lamb.)

Rami sæpè flexuosi. *Involucra* maxima, nivea, extùs præsertim apices squamarum versus atro-sanguinea. *Receptaculum* planum, favoso-paleaceum.

9. *A. imbricatum*, foliis lanceolatis imbricatis tomentosis, pedunculis solitariis squamosis, involucri squamis ovatis acuminatis.

Xeranthemum imbricatum, Linn. Amœn. Acad. 6. p. 100.—Thunb. Prod. 153.

Elichrysum imbricatum, Willd. Sp. Pl. 3. p. 1905.

Hab. ad Promontorium Bonæ Spei. *Thunberg, Labillardiere, Menzies, Joannes Roxburgh.* h. (v. s. sp. in Herb. Lamb.)

Involucra rosea. *Receptaculum* hemisphæricum, processibus numerosis, subcarnosis mollibus instructum.

10. *A. canescens*, foliis ovatis imbricatis tomentosis, pedunculis solitariis squamosis, involucri squamis ovatis acutis.

Xeranthemum canescens, Linn. Amœn. Acad. 6. p. 100,

Elichrysum canescens, Willd. Sp. Pl. 3. p. 1906.

Hab. in Promontorio Bonæ Spei. *Menzies, Joannes Roxburgh.* h. (v. s. sp. in Herb. Lamb.)

Receptaculum ut in præcedente, cui planta maxime affinis est.

Mr Brown first constituted as a distinct genus, under the name of *Astelma*, the *Gnaphalium eximium* of Linnæus; but as the character given by Mr Brown, in the Botanical Register, appears to be constructed solely from *eximium*, I have found it necessary to give a new one, in order to include *Gnaphalium milleflorum*, and several species of *Elichrysum*, which cannot be removed from this genus. The receptacle of *Astelma eximium* is by no means naked, but it is distinctly honey-combed; and the involucre, in an advanced state, becomes radiant like the *A. variegatum*, although less decidedly so. There are many genera, which are truly natural, included in this family, which afford numerous instances, tending to shew that the involucre, whether radiant or connivent, is not a character of generic importance in this tribe of plants. The fundamental character of *Astelma*, therefore, is to be found in the plumose

pappus, whose rays are united for a considerable way above the base, like that of *Carlina*, as we have already remarked. I have placed at the end of the species *A. imbricatum* and *canescens*, as they appear to form the link between *Astelma* and the following genus.

APHELEXIS.

XERANTHEMI sp. *Linn.*

ELICHRYSI sp. *Willd.*

Involucrum campanulatum, laxè imbricatum, scariosum, coloratum, longè radiatum. *Receptaculum* planum, crebrè paleaceum: *paleis* rigidis, mucronatis, simplicibus, aut bitripartitisve. *Flosculi* omnes hermaphroditi, tubulosi, 5-dentati. *Antheræ* basi biplumatae. *Stigma* bipartitum: *laciniiis* recurvatis, apice incrassatis truncatisque. *Pappi radiis* plumosis, basi connexis.

Suffrutices (Africæ australis) *ramosissimi*. *Rami virgati, filiformes, uniflori niveo-lanati*. *Folia acerosa, suprâ sulco exarata, nudiuscula, basi dilatata, sæpiùs imbricata*. *Flores solitarii, magni, nivei, purpurei v. sulphurei*.

1. *A. sesamoides*, foliis omnibus trigonis adpressis, floribus sessilibus, involucris squamis ovato-lanceolatis acutis, paleis linearibus simplicibus.

Xeranthemum sesamoides, Linn. Sp. Pl. 1203.—Thunb. Prod. 152.

Elichrysum sesamoides, Willd. Sp. Pl. 3. p. 1909.

β floribus purpureis.

Hab. ad Promontorium Bonæ Spei. *Thunberg, Masson, Niven, E. Lambert, Joannes Roxburgh.* h. (v. v. c. et s. sp. α et β in Herb. Lamb.)

Rami virgati, filiformes. Flores nivei, maximi.

2. *A. fasciculata*, foliis inferioribus filiformibus patulis;

rameis adpressis trigonis, pedunculis squamosis, involucri squamis ovato-lanceolatis acutis, paleis lanceolatis carinatis.

Xeranthemum fasciculatum, Andrew's Rep. t. 242.

Elichrysum fasciculatum, Willd. Sp. Pl. 3. p. 1909.

β floribus argenteis, Andr. l. c. t. 279.

γ floribus roseis.

Hab. in Promontorio Bonæ Spei. *Masson, Niven, Joannes Roxburgh.* h. (v. v. c. et s. sp. α , β , et γ , in Herb. Lamb.)

Rami virgati, filiformes. *Folia inferiora* patula, 2-3-pollicaria. *Flores* citrini. *Paleæ* simplices, aut bi- v. tripartitæ.

3. *A. filiformis*, foliis inferioribus filiformibus patulis; rameis adpressis trigonis, floribus subsessilibus, involucri squamis ellipticis obtusis, paleis lanceolatis carinatis.

Elichrysum filiforme, Hortulanis.

β floribus roseis.

γ floribus citrinis.

Hab. ad Promontorium Bonæ Spei. *Niven, Joannes Roxburgh.* h. (v. v. c. et s. sp. α , β et γ in Herb. Lamb.)

Rami virgati, filiformes. *Folia inferiora* patula, 3-4-pollicaria. *Flores* omnibus minores, argentei. *Paleæ* simplices v. divisæ.

4. *A. humilis*, foliis teretibus erecto-patulis rigidis basi latè dilatatis, pedunculis squamosis, involucri squamis ovatis acutis, receptaculo favoso.

Elichrysum humile, Andrew's Rep. t. 652.

β floribus niveis.

Hab. in Promontorio Bonæ Spei. *Masson, Labillardiere, Niven.* h. (v. v. c. et s. sp. α et β in Herb. Lamb.)

Frutex humilior, rigidior. *Folia* breviora ac latiora, rigida, erecto-patula. *Flores* rosei, speciosi.

The peculiar habit of the species which compose this genus, would seem of itself sufficient to warrant its separation from the preceding. The shortness of the florets, when compared with the length of the scales, composing the bell-shaped involucre, and the receptacle being beset with rigid, pointed paleæ, will serve to confirm the separation. The rays of the seed-crown are merely united at the base. The colour of the involucre varies in the different species from white to purple and yellow. The generic name, which is intended to denote the remarkable simplicity of form observable in all the species of this genus, I have derived from $\alpha\phi\epsilon\lambda\eta\varsigma$, *simplex*, and $\epsilon\zeta\iota\varsigma$, *habitus*.

EUCHLORIS.

GNAPHALII sp. *Linn.*

Involucreum subrotundum, imbricatum, scariosum, coloratum, connivens: *squamis* rotundo-ovalibus, membranaceis. *Receptaculum* paleis angulatis, retusis, rigidis, in communis conniventibus, basi coalitis crebrè tectum. *Flosculi* omnes hermaphroditi, tubulosi, 5-dentati. *Antheræ* basi bip Plumatae. *Stigma* bipartitum: *laciniis* linearibus, truncatis. *Pappi radiis* basi connexis, apice peniculatis.

Herba (Africæ australis) *perennis, sempervirens, nuda*. *Caulis erectus, simplex, firmus, teres, supernè aphyllus, sesquipedalis*. *Folia elliptico-oblonga, obtusa, 5-nervia, integerrima, utrinque nuda, viridia, coriacea, 3-4-pollicaria, petiolata*; *caulina amplexicaulia*. *Flores terminales, numerosissimi, compositè corymbosi, magnitudine Antennariæ margaritacæ, nivei*.

1. *E. nudifolia*.

Gnaphalium nudifolium, Linn.

Hab. in Promontorio Bonæ Spei. *Roxburgh. 4.* (v. s. sp. in Herb. Lamb.)

This plant is perfectly green, and entirely destitute of the woolliness so peculiar to this tribe of plants. The form and disposition of the paleæ are sufficient to distinguish it. The pappus resembles very much in structure that of the male of *Leontopodium*, and of some species of *Antennaria*. The generic name alludes to the smooth and green appearance of the plant, and is derived from *εὔ*, *bellè*, and *χλωρὸς*, *viridis*.

HELICHRYSUM.

ELICHRYSI et GNAPHALII sp. Willd.

Involucrum imbricatum, scariosum, coloratum, connivens v. radiatum. *Receptaculum* nudum. *Flosculi* omnes hermaphroditi, tubulosi, 5-dentati. *Antheræ* basi biplumatae. *Stigma* bipartitum: *laciniis* linearibus, apice incrassatis truncatisque. *Pappi radiis* capillaceis denticulatis v. apice peniculatis, basi connexis v. solutis.

Herbæ v. Frutices (Asiæ, Africæ et Americæ) *plerumque* niveo-tomentosi. *Folia* alterna, sessilia, patula. *Flores* terminales, solitarii v. corymbosi, aurei, rosei, aut nivei.

The genus *Helichrysum*, as here limited, is distinguished by a naked receptacle, and a capillary seed-crown. It will thus include a large proportion of the Linnæan *Gnaphalia*. In my *Prodromus Floræ Nepalensis*, I had inadvertently united with this genus the *Astelma* of Brown, although the character there given could not include the latter genus. In several species belonging to *Helichrysum* we find the pappus has a striking analogy to the male pappus of *Leontopodium*, and to some species of *Antennaria*. I have followed Persoon in restoring the aspiration to the name; *Elichrysum*, adopted by Willdenow, being contrary to analogy. The following are the species belonging to this genus, viz

Elichrysum fulgidum Willd., *bellidioides* Willd., *dealbatum* and *scorpioides* Labill., *bracteatum* and *rigidum* Andr., *Helichrysum stoloniferum* and *elegans* Prod. Fl. Nep., *Gnaphalium arboreum* L., *grandiflorum* L., *fruticans* L., *congestum* L., *patulum* L., *ignescens* L., *Stæchas* L., *petiolatum* L., *crassifolium* L., *capitellatum* Thunb., *orientale* L., *arenarium* L., *lavendulæfolium* Willd., *rutilans* L., *cymosum* L., *apiculatum* Labill. These are all of the published species I have yet determined, owing to the vagueness of the descriptions given by authors, and the want of good figures to determine precisely the plants they intend. There are, besides, a great number of unpublished species from New Holland and the Cape of Good Hope.

PENTATAXIS.

Involucrum oblongum, pauciflosculosum, pentagonum: *squamis* coloratis, obtusis, adpressè 5-fariam imbricatis, supra torum brevem digestis. *Receptaculum* parvum, favosum. *Flosculi* 5, hermaphroditi, tubulosi, 5-dentati. *Antheræ* basi biplumatæ. *Stigma* bifidum, inclusum: *laciniis* semicylindricis, truncatis. *Pappus* capillaris, serrulatus: *radiis* basi connexis.

Suffrutex (Africæ australis) *erectus*, *ramosus*, *niveolanatus*. *Rami* *elongati*. *Folia* *alterna*, *lanceolata*, *acuta*, *amplexicaulia*, *marginè integerrima*, *crispata*. *Corymbus* *compositus*, *glomeratus*, *Achyranthis* *faciè*. *Flores* *parvi*, *nivei*.

1. *P. micrantha*.

Hab. in Promontorio Bonæ Spei. *Labillardiere*. h. (v. s. sp. in Herb. Lamb.)

This genus is closely allied, both in habit and character, to *Cassinia* of Brown, a genus peculiar to New Holland and New Zealand. It differs, however, in having a honey-combed receptacle, which in *Cassinia* is clothed with paleæ, resembling the inner scales of the involucre. In Mr Brown's *Ozothamnus*, a genus very nearly related both to *Cassinia* and *Pentataxis*, the receptacle is quite naked. The curious arrangement of the scales of the involucre in our genus is also found in *Cassinia quinquefaria* of Brown, and there the scales are likewise disposed in five series. To this curious disposition of the scales of the involucre, the name I have given is intended to apply. It is composed of $\pi\epsilon\upsilon\tau\epsilon$, *quinque*, and $\tau\alpha\acute{\xi}\iota\varsigma$, *series*.

SPIRALEPIS.

GNAPHALII sp. *Thunb., Willd.*

Involucre polyphyllum, imbricatum; *squamis interioribus* in acumen longum subulatum recurvato-tortuosum canaliculatum desinentibus, et radium revolutum, coloratum efformantibus. *Receptaculum* parvum, nudum, scrobiculatum. *Flosculi* omnes hermaphroditi, tubulosi, 5-dentati. *Antheræ* basi biplumatae. *Stigma* bipartitum: *laciniis* apice incrassatis truncatisque. *Pappus* capillaris, niveus, denticulatus, persistens: *radiis* basi solutis.

Herbæ (Africæ australis) *perennes, procumbentes, ramosæ, niveo-lanatae*. Folia *alterna, sessilia, integerrima*. Flores *glomerati, bracteati, albi, rosei v. purpurei*.

1. *S. squarrosa*, foliis lingulatis obtusis, capitulis congestis multifloris, caule assurgente.

Gnaphalium squarrosum, Linn. Sp. Pl. 1197.—Thunb. Prod. 151.—Jacq. Fragm. p. 6. t. 3. f. 4. (bona).—Willd. Sp. Pl. 3. p. 1877.

Hab. in Promontorio Bonæ Spei. *Thunberg, Joannes Roxburgh*. 7. (v. s. sp. in Herb. Lamb.)

2. *S. glomerata*, foliis spathulatis petiolatis, capitulis foliosis, caule diffuso: ramis elongatis.

Gnaphalium glomeratum, Linn. Amœn. Acad. 6. p. 99.—Thunb. Prod. 151.—Willd. Sp. Pl. 3. p. 1891.

Hab. in planitie arida prope Caput Bonæ Spei. *Thunberg, Niven.* 4. (v. s. sp. in Herb. Lamb.)

3. *S. tincta*, foliis cuneato-rotundatis, capitulis paucifloris, caule prostrato radicante.

Gnaphalium tinctum, Thunb. Prod. 151.—Willd. Sp. Pl. 3. p. 1877.

Hab. ad Promontorium Bonæ Spei. *Labillardiere.* 4. (v. s. sp. in Herb. Lamb.)

4. *S. rotundifolia*, foliis cuneato-rotundatis rugosissimis, capitulis globosis, caule procumbente.

Gnaphalium rotundifolium, Thunb. Prod. 152.—Willd. l. c. 3. p. 1901.

Hab. in Capite Bonæ Spei. *J. Roxburgh.* 4. (v. s. sp. in Herb. Lamb.)

I have separated this genus from *Helichrysum*, on account of the peculiar structure of its involucre, whose scales are nearly of equal length, and terminated by a long twisted point, to which the generic name alludes. The species agree so well in habit and character, that, although perfectly distinct, they are with difficulty characterised, so as to be easily known. The generic name is composed of *σπιρα*, *spira*, and *λεπις*, *squama*.

PETALACTE.

GNAPHALII sp. *Linn., Willd.*

Involucrum cylindraceum, simplici serie polyphyllum: *foliis* linearibus, distinctis, æqualibus, apice laminâ petaloideâ orbiculatâ scariosâ coloratâ patulâ radiatis. *Recepta-*

culum parvum, favosum. *Flosculi* omnes hermaphroditi, tubulosi, 5-dentati. *Antheræ* basi bisetæ: *setis* obtusis, nudis. *Stigmata* linearia, truncata. *Pappus* niveus, caducus: *radiis* basi solutis, apice penicillatis.

Frutices (Africæ australis) *humiles, lanati, erecti*. Folia *sparsa, mucronulata, integerrima, sessilia, coriacea*. Flores *terminales, fasciculato-corymbosi, pulchri, albi aut purpurei*.

1. *P. coronata*, foliis lanceolatis, radio concolori.

Gnaphalium coronatum, Linn. Sp. Pl. 1191.—Thunb. Prod. 149.—Willd. l. c. 3. p. 1854.

Hab. ad Promontorium Bonæ Spei, in declivitate Montis Tabularii. *Niven, Joannes Roxburgh*. h. Floret Octobri et Novembri. (v. s. sp. in Herb. Lamb.)

Fruticulus cæspitosus, palmaris. *Flores* fasciculatim corymbosi: *radio* niveo.

2. *P. bicolor*, foliis spathulatis, radio bicolori.

Hab. in Capite Bonæ Spei. *J. Roxburgh*. h. (v. s. sp. in Herb. Lamb.)

Præcedenti similis. *Involucris* *radius* purpureus et niveus.

The genus *Petalacte* is essentially distinguished by having a simple involucre, whose leaflets are of equal length, and furnished at the top with a broad, orbicular, coloured lamina, which give the flowers some distant resemblance to those of *Achillea Ptarmica*. The pappus is caducous, with the rays unconnected at the base. The setæ at the base of the anthers are naked and obtuse. The name alludes to the petaliform rays of the involucre, and is derived from *πετάλα*, *petalum*, and *ακτιν*, *radius*.

PHÆNOCOMA.

ELICHRYSI sp. *Willd.*XERANTHEMI sp. *Linn.*

Involucrum globosum : *squamis* lanceolatis, mucronatis, basi adpressis ; *interioribus* multiplici serie radiatis, longis, erectis, coloratis. *Receptaculum* conicum, nudum. *Flosculi* *feminei* marginales, filiformi-tubulosi, fauce coarctati, obtusè 5-dentati, rudimentis staminum nullis ; *masculi* numerosissimi, tubulosi, supra medium ventricosi, fauce coarctatâ, obtusè 5-dentati. *Antheræ* basi bisetosæ : *setis* tenuissimis, nudis. *Stigma* masculis inclusum, indivisum, truncatum ; *fœmineis* bipartitum, exsertum : *laciniis* linearibus recurvatis, truncatis emarginatisque. *Achenia* difformia ; *fœmineis* ovali-oblonga, undique villosissima ; masculis linearia, glabra. *Pappus* uniformis : *radiis* apice peniculatis, basi levitè connexis.

Frutex habitu anomalus, erectus, rigidissimus, proliferè ramosissimus, lanugine niveâ appressâ tectus. Ramuli foliiferi, brevissimi (nunc semiunciales) conferti, patuli. Folia minuta, granulata, adpressè 5-fariam imbricata, nuda, nitida. Flores magni, terminales, solitarii, sessiles, purpureo-coccinei, splendidissimi.

1. *P. prolifera.*

Xeranthemum proliferum, Linn. Sp. Pl. p. 1202.—Thunb. Prod. 152.
Elichrysum proliferum, Willd. Sp. Pl. 3. p. 1905.

Hab. ad Promontorium Bonæ Spei. *Thunberg, Masson, Labillardiere, Niven.* 17. (v. v. c. et s. sp. in Herb. Lamb.)

This is one of the most splendid plants that can well be imagined. Its anomalous and almost leafless habit, and its large magnificent flowers, form a striking object. It could not therefore fail to attract the attention of the earliest

voyagers to the Cape of Good Hope; but, although it has been so long known to botanists, there are few plants that have been less understood than it. The female florets being five-toothed and tubular, and the naked slender setæ at the base of the anthers, together with the uniformity of the pappus in both the male and female florets, as well as the naked conical receptacle, will serve at once to distinguish it. This genus agrees in several respects with *Xeranthemum*. The name is derived from φαεινος, *splendidus*, and κομα, *coma*, and is intended to denote its brilliant coloured involucre.

CARPHOLOMA.

Involucrum oblongum, cylindraceum, imbricatum, lanatum, nec scariosum, nec radiatum: *squamis* adpressis, apice spinosis, patulis. *Receptaculum* planum, in peripheriâ solâ paleis distinctis setaceis instructum. *Flosculi* omnes hermaphroditi, tubulosi, 5-dentati. *Antheræ* basi bisetæ: *setis* puberulis. *Stigma* bipartitum: *laciniis* angustis, apice incrassatis truncatisque. *Pappus* pilosus, serrulatus: *radiis* basi fasciculatim connexis.

Frutex (Africæ australis) *erectus, rigidus, ramosissimus, niveo-lanatus*. Folia *fasciculata, brevia, teretiuscula, obtusa*. Flores *terminales, solitarii, purpurascetes*.

1. *C. rigidum*.

Hab. in Promontorio Bonæ Spei. *Labillardiere*. 17. (v. s. sp. in Herb. Lamb.)

This is a very distinct and well-marked genus, on account of its spinose, truncate involucre, which is neither scarioso nor coloured, and flat receptacle, whose circumference is furnished with several slender paleæ. The resemblance between the involucre of our plant and that of the true

Carduaceæ, is another proof in support of the opinions I have advanced in the preface. We have here the involucre of the *Carduaceæ* united with the florets and truncated stigmas of *Gnaphalium*. The name is derived from *καρφος*, *palea*, and *λωριμ*, *margo*, in allusion to the paleaceous margin of the receptacle.

METALASIA, *Brown*.

ANTENNARIÆ sp. *Gærtn*.

GNAPHALII sp. *Linn., Willd*.

Involucrum cylindræum, adpressè imbricatum: *squamis intimis* scariosis, coloratis, sæpè radiatis. *Receptaculum* minutum, scrobiculatum. *Flosculi* omnes hermaphroditi, tubulosi, 5-dentati. *Antheræ* basi biplumatae. *Stigma* bipartitum: *laciniis* apice incrassatis truncatisque. *Pappi radiis* basi solutis, setaceis v. plerumque subulatis, planis, supernè dilatatis, margine tenuissimè serrulatis.

Frutices (Africæ australis) *aridi, rigidi, facie sæpè juniperinâ, ramosissimi*. Folia *sparsa v. fasciculata, rigida, plerumque tortuosa, quasi resupinata, pungenti-mucronata*. Flores *terminales, glomerati v. solitarii, albi, rosei, aut aurei*.

* *Foliis fasciculatis tortis, quasi resupinatis*.

1. *M. umbellata*, foliis ovato-lanceolatis subulatisve mucronatis patulis, floribus aggregatis sessilibus fastigiatis lanatis, involucri radiis intimis ovalibus obtusis integris, pappo subulato acuto.

Gnaphalium umbellatum, Linn. Suppl. 363.—Thunb. Prod. 147.—Willd. Sp. Pl. 3. p. 1861.

Hab. in Capite Bonæ Spei. *Thunberg, Masson*. 1. (v. sp. in Herb. Lamb.)

Frutex rigidissimus, divaricato-ramosissimus: *ramis di-*

chotomis. *Folia primaria* ovato-lanceolata; *fascicularum* subulata. *Involucri squamis* roseis.

2. *M. muricata*, foliis lineari-subulatis pungentibus deflexis, involucris radiis intimis ovalibus obsolete 3-dentatis, pappo subulato obtuso.

Gnaphalium muricatum, Linn. Sp. Pl. 1192.—Thunb. Prod. 148.—Willd. Sp. Pl. 3. p. 1856.

Hab. in Capite Bonæ Spei. *Thunberg, Labillardiere. h.*
(v. s. sp. in Herb. Lamb.)

Folia duplò longiora quàm in præcedente.

3. *M. divergens*, foliis lineari-lanceolatis pungentibus deflexis, floribus aggregatis sessilibus, radiis intimis involucris lanceolatis acutis, pappo subulato obtuso.

Gnaphalium divergens, Thunb. Prod. 148.—Willd. Sp. Pl. 3. p. 1857.

Hab. in Capite Bonæ Spei. *Thunberg, Labillardiere. h.*
(v. s. sp. in Herb. Lamb.)

Folia uncialia. *Capitula* minora.

4. *M. fasciculata*, foliis lineari-lanceolatis mucronatis, corymbo composito patulo, radiis involucris lanceolatis apice dentatis, pappo subulato, ramis erectis fastigiatis.

Gnaphalium fasciculatum, Thunb. Prod. 148.—Willd. Sp. Pl. 3. p. 1858.

Hab. in Capite Bonæ Spei. *Thunberg, Labillardiere. h.*
(v. s. sp. in Herb. Lamb.)

5. *M. fastigiata*, foliis lanceolatis mucronatis, corymbo composito patulo, radiis involucris lanceolatis mucronatis, pappo subulato, ramis patulis.

Gnaphalium fastigiatum, Thunb. Prod. 148.—Willd. Sp. Pl. 3. p. 1859.

Hab. ad Caput Bonæ Spei. *Thunberg. h.* (v. s. sp. in Herb. Lamb.)

6. *M. aurea*, foliis subulatis pungentibus, capitulis corymbosis fastigiatis, involucri squamis intimis rotundatis disco æqualibus, pappo subulato obtuso.

Hab. in planitie aridâ ad Promontorium Bonæ Spei juxta ripas fluminis Camtas dicti. *Niven.* h. (v. s. sp. in Herb. Lamb.)

Frutex 4-pedalis, rigidissimus. *Flores* aurei. *Involucra* cylindrica, semiuncialia.

7. *M. hispida*, foliis lineari-subulatis mucronatis ciliato-hispidis, capitulis aggregatis subsessilibus, involucri radiis oblongis obtusis.

Gnaphalium hispidum, Linn. Suppl. 363.—Thunb. Prod. 148.—Willd. Sp. Pl. 3. p. 1857.

Hab. ad Caput Bonæ Spei. *Thunberg.* h.

8. *M. polyanthos*, foliis lineari-subulatis mucronatis, corymbo composito paniculato, radiis involucri lanceolatis acutis.

Gnaphalium polyanthos, Thunb. Prod. 147.—Willd. Sp. Pl. 3. p. 1859.

Hab. in Capite Bonæ Spei. *Thunberg.* h.

9. *M. seriphioides*, foliis lineari-subulatis inermibus, floribus lateralibus sessilibus.

Gnaphalium seriphioides, Berg. cap. 267. (exclus. synonym.)—Thunb. Prod. 148.—Willd. Sp. Pl. 3. p. 1860.

Hab. in Promontorio Bonæ Spei. *Thunberg.* h.

** *Foliis solitariis strictis, nec resupinatis.*

10. *M. pungens*, foliis ovato-lanceolatis mucronatis laxè quadrifariam imbricatis, umbellis capitatis, involucri radiis ovatis mucronatis, pappo subulato obtusiusculo.

Hab. ad Promontorium Bonæ Spei. *Niven.* h. (v. s. sp. in Herb. Lamb.)

11. *M. uniflora*, foliis ovatis mucronatis laxè quadrifariam imbricatis, floribus subsolitariis, involucris radiis lanceolatis mucronatis, pappo setaceo colorato basi coalito.

Hab. ad Caput Bonæ Spei. *Labillardiere*. h. (v. s. sp. in Herb. Lamb.)

Frutex erectus, rigidus, *Diosmæ imbricatæ* facie. *Flores* 5-plò omnibus majores, radio niveo.

12. *M. phyllicoides*, foliis ovali-oblongis obtusè mucronulatis villosis 4-fariam imbricatis subtùs concavis, capitulis globosis, involucris radiis ovalibus obtusis, pappo capillari basi soluto.

Gnaphalium phyllicoides, Niven MSS.

Hab. ad Promontorium Bonæ Spei, in locis siccis elevatis. *Niven*. h. (v. s. sp. in Herb. Lamb.)

Frutex pedalis, erectus, rigidus, *Phyllicæ* facie. *Flores* capitati, radio niveo.

The genus *Metalasia* was separated by Mr Brown* from *Antennaria*, in which it had been included by Gærtner. Its habit and character are so widely different from *Antennaria*, as limited by Mr Brown, that we are surprised so distinguished a botanist as Gærtner should have united them. The leaves of most of the species of this genus are convex and smooth underneath, and concave and woolly on the upper surface, but by a peculiar twisting they become as if resupinate. That it is the upper surface which is concave and woolly, and not the under, will be at once seen, by examining the situation of the young leaves. In *M. pungens* the leaves have no twisting, and there the natural position of the leaves is evident.

* Linn. Trans. vol. 12, p. 122.

I have placed at the end two doubtful species, namely, *M. uniflora* and *phylicoides*, both of which differ very materially from the other species in the structure of their pappus. The former has leaves very similar to those of *M. pungens*, and agreeing with them also in their position; but the latter has the leaves truly concave on the under surface, and convex above.

ANTENNARIA, *Brown.*

ANTENNARIÆ sp. *Gærtn.*

GNAPHALII sp. *Linn.*

Involucrum polyphyllum, imbricatum, scariosum, coloratum; fœmineis connivens. *Receptaculum* planum, epaleatum, serobiculatum. *Flosculi* dioici; *masculi* tubulosi, 5-dentati; *fœminei* tenuissimi, filiformes: *limbo* minuto, obliquo, 3-denticulato. *Antheræ* basi biplumatae. *Stigma* exsertum, bipartitum laciniis obtusis; masculis inclusum, indivisum. *Pappus* difformis; *masculus* radiis apice v. incrassatis planis v. peniculatis; *fœmineus* capillaris, denticulatus, involucro multò longior, penicillatus.

Herbæ perennes, cæspitosa, niveo-lanata; masculinæ longè robustiores ac pulchriores. Caules simplices. Folia alterna, sessilia, integerrima, sæpè basi decurrentia; radicalia sæpè maxima, patentia. Flores terminales, corymbosi, albi v. rariùs rosei. Prod. Fl. Nepal. p. 174. (characterè paulo mutato.)

There are several remarkable peculiarities relating to the flowers of the different sexes, some of which appear to me not to have been before remarked. The first is, that the involucre of the male flowers, those most frequently described, are more highly coloured, generally spherical, with the scales broad, obtuse, loosely imbricated or spreading, the innermost ones forming a ray considerably longer than the florets and pappus. The florets are also shorter than the pappus,

the rays of which are spreading. In the second place, the female involucre, on the contrary, are longer, cylindrical, with elongated, adpressed, mostly pointed, scales, the innermost series connivent, and shorter than the pappus, which is closely pressed together, and has a striking resemblance to a camel-hair-pencil. The circumstance of the scales of the female involucre being uniformly longer, and generally pointed, has given rise to frequent mistakes in characterising the species. In the common *Antennaria dioica* the scales of the male involucre are broad and rounded, while those of the female are lanceolate and pointed. The same will be found to be the case with the *Antennaria alpina*, the female of which has always been described. There are specimens both of the male and female of this plant in the herbarium of the late Earl of Bute, now in Mr Lambert's possession. They were collected on the Swiss Alps by M. Garcin. The pappus appears to me to afford the most satisfactory specific characters.

LEONTOPODIUM, *Brown.*

ANTENNARIÆ sp. *Gærtn.*

GNAPHALII sp. *Linn.*

Involucreum hemisphæricum, imbricatum, lanosum, truncatum: *squamis* apice sphacelatis. *Receptaculum* planum, favosum. *Flosculi* polygami; *masculi* tubulosi, 5-dentati; *feminei* filiformes: *limbo* obliquo, 3-denato. *Antheræ* basi setis 2, tenuissimis nudis instructæ. *Stigma* fœmineis bipartitum exsertum: *laciniis* linearibus, obtusis. *Pappus* difformis, basi connexis; *masculus* densissimus radiis apice peniculatis, involucre æqualibus, quasi truncatis; *fœmineus* capillaris, denticulatus, involucre vix longior.

Herbæ perennes, densè niveo-lanatæ, caspitosa. Folia alterna, integerrima; radicalibus maximis. Flores termi-

nales, numerosi, in capitulum planum collocati, sessiles, bracteis numerosis lanceolatis lanosis radiatim patulis involucrati. Involucra centralia sæpiùs mascula. Flosculi masculi fœmineis v. neutris, et fœminei masculis intermixti.

1. *L. alpinum*, capitulis solitariis sessilibus.

Gnaphalium Leontopodium, Lam. Encycl. 2. p. 751.—Scop. Carn. 2. p. 150.—Jacq. Austr. 1. t. 86.—Willd. Sp. Pl. 3. p. 1892.

Filago Leontopodium, Linn. Sp. Pl. 1312.

Hab. in Alpibus Helveticis, Austriacis, Valeriacis, Carinthiacis, et Delphinatus. 4. (v. s. sp. in Herb. illustriss. Comitum de Bute, nunc in Mus. Lamb.)

2. *L. sibiricum*, capitulis pluribus pedunculatis.

Gnaphalium Leontopodioides, Willd. Sp. Pl. 3. p. 1893.

Filago Leontopodium, Pallas MSS.

Hab. in Sibiria orientali, ubi legit ann. 1789. *D. Merk.* 4. (v. s. sp. in Herb. Pallas. nunc in Mus. Lamb.)

Caulis altior. *Folia* radicalia lanceolata, petiolata. *Capitula* plura, pedunculata.

In my 'Prodromus Floræ Nepalensis,' I had proposed to unite this genus to *Gnaphalium*, although it would certainly have been much more natural to have placed it with *Antennaria*, in which it had been included by Gærtner. The truncate polygamous flowers, the hemispherical, non-scariose, rayless involucre, and the simple setæ at the base of the anthers, alone distinguish it from *Antennaria*; but as these characters, joined to the remarkable bractæ, appear to warrant such a separation, I have willingly followed Mr Brown in the expediency of keeping them distinct. Both species are polygamous; that is, they have either separate stalks bearing male and female heads of flowers from the same root, or the centre involucre in each head is male, and surrounded by several female ones. The female involucre are constantly furnished with some male florets, and the male involucre with either female, or neuter ones.

GNAPHALIUM, *Brown.*GNAPHALII sp. *Linn.*

Involucrum polyphyllum, imbricatum, scariosum, coloratum, connivens. *Receptaculum* planum, nudum (rarò favosum). *Flosculi marginales* foeminei, numerosi, filiformes, tenuissimi: *limbo* minuto, obliquo, 3-denticulato; *centrales* masculi, pauci, tubulosi, 5-dentati. *Antheræ* coalitæ, basi bisetosæ. *Stigma* bifidum, in *masculis* inclusum, ac incompletum. *Pappus* tenuissimus, capillaris, denticulatus, utriusque sexus consimilis.

Herbæ (*pleræque annuæ et extra tropicæ*), *humiles, ramosæ, niveo-lanatæ*. Folia *alterna, sessilia, integra*. Flores *terminales, corymbosi v. glomerati, albi aut aurei*. Prod. Fl. Nepal. 172.

The genus *Gnaphalium*, as now limited, forms a very natural and distinct group. It is abundantly characterised by having its male and female florets in the same involucrem, and by the uniformity of its pappus in both sexes. In the structure of its flowers, *Gnaphalium* has a striking analogy to *Erigeron*, as constituted by me in the 'Prodrömus Floræ Nepalensis;' but the latter differs essentially in the anthers being destitute of setæ at their base. This genus forms, through the *Conyzææ*, the transition to the *Asterææ*, the family to which *Erigeron* belongs. The species belonging to this genus are, *Gnaphalium germanicum* Sm., *arvense* Willd., *montanum* Willd., *gallicum* Sm., *pyramidatum* Willd. (all included by Linnæus in his genus *Filago*), *uliginosum* L., *minimum* Sm., *fuscum* Scop., *pusillum* Hænke Sudet., *supinum* L., *multicaule* Willd., *americanum* Sw., *verticillatum* Thunb., *sylvaticum* L., *purpureum* L., *obtusifolium* L., *undulatum* L., *sanguineum* L., *luteoalbum* L., *affine* Fl. Nepal., *Busua* Fl. Nepal., *fætidum* L., *japonicum* Thunb., *polycephalum* Mich., *Lagopus* Willd.

Addendum to Dr GREVILLE'S Article, p. 483.

THE moss described under the name of *Neckera Americana* I have, since the article was printed, found to be previously described. It is the *Neckera minor* of SCHWEGR. Suppl. i. 2. p. 149, and the var. β of *N. viticulosa*, HEDW. Sp. p. 210. The reader is therefore requested to substitute the specific name of *minor* for that of *Americana*; though it is unaccountable how I could pass this over when describing the moss, yet the fact may serve to confirm the species, which appears to be very distinct, notwithstanding its great affinity with *N. viticulosa*.

APPENDIX.

HISTORY

OF THE

SOCIETY

(Continued from Vol. IV. p. 585.)

THE Secretary read a memoir on the Geographical Distribution of Plants in Yorkshire, by Mr Atkinson ; also, a Biographical Notice of Mary Noble of Penrith, in the 107th year of her age ; with some Remarks on Longevity, by Dr Thomas Barnes : and a Description of a New Species of *Regulus* from Brazil, accompanied with a Drawing, by Dr Traill. Professor Jameson then read the Reverend H. F. Borgesen's Description of Vettie's Giel, a striking scene in Norway.

1823.
May 31.

The Secretary read, *1st*, The Continuation of Dr Fleming's Voyage round the North of Scotland, in 1821 ; *2d*, Notice regarding the Migration of the Woodcock, by Major Morrison ; *3d*, The first part of a Paper on the power possessed by some species of Spiders of ascending into the air, by Mr John Murray, F. L. S., Lecturer on Chemistry.

June 14.

There were then communicated to the Society the Results of a Series of Thermometrical Observations, made hourly at Leith, during twenty-four successive hours, once every month, from July 1822 to July 1823, by Mr Coldstream. Professor Jameson communicated Dr Boué's answer to M. Beudant's opinion regarding the Crystalline Rocks of the Red-sandstone formation, as explained in the 3d volume of his *Voyages en Hongrie*; also the first part of Dr Francis Hamilton's Commentary on the Herbarium Amboinense.

1823.
Nov. 15.

The Secretary read a paper by the Reverend Mr Dunbar of Applegarth, confirming Shirach and Huber's doctrine of the occasional conversion of the larvæ of working bees into queen bees: also, a Notice from Dr Cumin of Glasgow, regarding the Formation of Young Tubers within the substance of a large Potato, with the original specimen, and a Drawing of it by Mr P. Syme. Dr Knox then gave an account of the Foramen centrale of Sœmmering, as discovered by him in the Eyes of certain Reptiles, illustrating his communication by anatomical preparations. The Secretary read Extracts from a Paper by Mr Marshall, on the Natural and Economical History of the Cocoa Nut-tree. Mr Parry exhibited to the meeting Colonel Miller's newly invented Percussion-Shell, and gave an account of some successful experiments made with it near Leith Fort. Mr Nicol repeated, in presence of the meeting, Döbereiner's remarkable experiment, shewing the ignition of the fine powder of platina, when exposed to a stream of hydrogen gas in atmospheric air.

1823.
Nov. 29.

Dr Knox read a Paper on the Organs of Digestion, Respiration, and Circulation, of the *Ornithorynchus paradoxus*, illustrating his description by stuffed specimens and a natu-

ral skeleton. The Secretary read the concluding part of Dr Fleming's Gleanings of Natural History, on a Voyage round the North of Scotland, in 1821: also a Notice of Remarkable Hailstones, of a pyramidal form, which fell in Aberdeen in June last, by Mr Robert Lindsay of Aberdeen. Mr Parry exhibited some Drawings made from carvings in oak, executed before the time of Henry VIII: and Professor Jameson laid before the meeting a chart, shewing the route pursued by Captain Parry through various parts of Baffin's Bay, during the three preceding summers.

Dr Knox read a Paper on the Kidneys, Urinary Bladder, and Organs of Generation in the Male of the *Ornithorhynchus paradoxus*, illustrating his descriptions by Sketches. Dr Yule gave an Account of the Changes produced on some Tallow Candles, which had been accidentally preserved in a dry state for near a century; and exhibited specimens. Mr Greville then read an Account of Mr Cormack's Journey across Newfoundland in 1822; and a short Paper narrating an instance of misdirected instinct in the common Frog, during the coupling season, communicated by Mr Burd. Professor Jameson gave an Account of Thermometrical and Hygrometrical Observations made at Port Callao, in South America, by Mr William Jameson, surgeon; and also read Extracts from a Letter, written from Funca, by Mr Bowdich, the African traveller.

1823,
Dec. 13.

Mr Greville read an Account of a Steinbart or Stone-axe, said to have been found imbedded in a layer of compact clay, under several beds of limestone, in Staffordshire; with Remarks on the geological consequences of this fact, if ascertained to be correct. Dr Knox read some Account of the

Dec. 27.

Quadrupeds met with on the Shores of the Inlets of Hudson's Bay, in Captain Parry's last Voyage, communicated by Dr Richardson.

1824.
Jan. 10.

Dr Richardson read the first part of an Account of the Animals collected and seen during the Overland Arctic Expedition, illustrating his remarks by shewing prepared Specimens of the Animals. Mr Arnott communicated a Paper by himself on some Species of Mosses.

Jan. 24.

Dr Richardson read the concluding part of his Account of Animals collected during the Overland Arctic Expedition, and exhibited Specimens. Dr Knox read a Paper on the mode of Growth, Reproduction, and Structure of the Poison-fangs of Serpents, illustrating his description by Preserved Specimens, Anatomical Preparations, and Sketches. Mr Menteach of Closeburn presented a Specimen of a Larch Plank, shewing the manner in which the Larch Tree begins to decay at the base of the trunk, when twenty or thirty years old, if planted over sandstone.

Feb. 7.

Professor Jameson read the introductory part of a Monograph on the genus *Larus*, by Mr Macgillivray; specimens of six of the species described were exhibited. The Secretary read an Account, contained in a letter to Professor Jameson, from Lieutenant Lamont, of the 91st Regiment, of the capture, in the West Indies, of an enormous Ray, popularly called the "Sea Devil," measuring fifteen feet in breadth, and almost as much in length. Dr Grierson of Cockpen read his General Observations on Geology, Geognosy, Oryctognosy, and Mineralogy, and on the Nature of these respective Studies.

Dr Knox read a Memoir on the Osseous, Muscular, and Nervous Systems of the *Ornithorynchus paradoxus*, illustrating his description of the osseous structure by a perfect skeleton of the animal. The Secretary read a deposition by three Shetland fishermen, Daniel and William Manson, and John Henderson, emitted on oath before Arthur Nicholson, Esq. of Lochend, Justice of the Peace, relative to a small cetaceous animal, of very uncommon appearance, which they had accidentally captured at the deep sea fishing, and taken into their boat, but soon afterwards released, from superstitious feelings, they having believed it to be a mermaid.

1824.
Feb. 21.

Professor Jameson read an Account of Petrified Shells found in the Gawilghur range of hills, and of the Structure of the Hill of Seetabuldee-Nagpoor, in the East Indies, by Mr Vaysey. A live Rattle-snake, newly arrived from South Carolina, and in a vigorous state, was exhibited to the meeting. Mr Parry read the first part of his Paper on the Management of Young Plantations, recommending, in the fir tribe, the practice of disbudding with the thumb, at a very early period, instead of pruning with the knife and saw at later times.

Mar. 6.

The Secretary read the second part of a Paper by Mr John Murray, F. L. S., on the Ascent of some species of Spiders into the air, shewing that this depends on their fine gossamer threads being peculiarly affected by the electric fluid of the atmosphere. Also two Papers by the Rev. Dr Fleming of Flish; the one containing an Account of a New British Species of *Spatangus*; and the other a Description of a New Species of *Plumularia*, collected in the late expedition under Captain Parry; with some Remarks on the

Mar. 20.

Sertulariadae found in Hudson's Straits. Mr Arnott then read a communication from Prideaux John Selby, Esq. of Twizel House, containing some curious particulars in the Natural History of the Golden Regulus.

1824.
April 3.

Mr Parry read a continuation of Notices regarding the Management of Young Plantations. Dr Knox then communicated some Remarks on the supposed Discoveries of Professor Tiedemann, and Dr Fohmann, relative to the non-existence, in the *Phoca vitulina*, of the *vasa efferentia*.

April 17.

Dr Knox read a short Paper on the *Colymbus septentrionalis*, or Red-throated Diver, shewing that the bones are black or dark-coloured, and that this coloration depends on the periosteum. Mr Deuchar communicated some Remarks on Meteoric Stones, and proposed a theory to account for their formation. At the same meeting, there was laid before the Society the first part of a Memoir on the Sandfield in the vicinity of Edinburgh, by Mr Alexander Blackadder.

May 1.

The Secretary read a communication sent to the Society, entitled, Observations and Experiments on the Formation of Pearls. Also, Notice of a Substitute for Cork, in Tropical Climates, being the central part of the scape of *Agave vivipara*; by the Reverend Lansdown Guilding of St Vincent; with Specimens of the Prepared Agave-Cork. And likewise an Account of William Dempster, who accidentally swallowed a large Table-knife, at Carlisle in November last, by Dr Barnes of Carlisle. Professor Jameson read a Notice of the Discovery of some Fossil Remains of a Whale found near the seat of Lord Dunmore, on the banks of the

Forth, and at several hundred yards distance from the present bed of the river; communicated by Mr Alexander Blackadder, Allan-Park. A stuffed specimen of the Dog of New South Wales, presented to the Museum by Governor Brisbane, was then exhibited, and described by Professor Jameson.

Professor Jameson communicated Mr A. Blackadder's Observations on the Alluvial Strata of the Forth District, illustrated by a Geognostical Map. Mr Witham of Lartington read a Memoir on some peculiarities existing in the Trap Rocks in the west and north-west of the counties of York, Durham, Westmoreland, and Northumberland. The Secretary read a Notice regarding the Pernicious Effects on Fruit-trees, of the layer of bog-iron-ore immediately under the surface-soil in Aberdeenshire, provincially termed *pan*; communicated by Mr Stevenson, Civil-Engineer. Mr F. A. Parry exhibited a remarkable stalagmite or deposition formed at the bottom of one of the tanks of lime-water at Canongate of Edinburgh, through which the coal-gas is passed with a view to its purification. Mr Deuchar then communicated his view of the comparative merits of the different Theories of Galvanic Action.

1824.
May 15.

The Secretary read, *1st*, A Notice of the incarceration of a live Toad (*Rana verrucosa*) in the wall of Fort-William Barracks, Calcutta, for the period of fifty-four years; communicated by Major-General Hardwick; *2d*, Account of the Monocotyledonous and Acotyledonous Plants found between the 4th and 11th degrees of north latitude, on the western coast of Africa; by Mr George Don; *3d*, Notice of a viviparous variety of *Juncus lampocarpus*; communicated by Mr Parry.

Nov. 13.

1824.
Dec. 4.

The Secretary read two communications relative to the discovery of the Bones of a Grampus or Small Whale, in the carse-clay, lying over black peat-moss, on the estate of Blair Drummond; the one communication by Henry Home Drummond, Esq. M. P., and the other from Mr A. Blackadder, surveyor. There were likewise laid before the meeting, Meteorological Observations made at Guayaquil, from January to June 1824, by William Jameson, Esq. surgeon; and Barometrical Observations between the Pacific Ocean and Mendoza, in the year 1821, by Dr Gillies. Dr Barclay presented a letter from Dr Mease of Philadelphia, accompanying a specimen of the Siren lacertina, for the Society's collection.

Dec. 18.

The Secretary read, *1st*, A communication from Dr Treviranus of Bremen, on the Cochlea of the Internal Ear of Birds; *2d*, A Notice by Mr J. W. Reddoch of Falkirk, regarding the Bones of a Quadruped, found in a bed of clay, and of razor-shells found in a bed of sand under the clay, near Camelon, ninety feet above the present level of the Forth; *3d*, The description, by Dr Traill of Liverpool, of a New Species of Silurus, *S. Parkeri*, found in the river at Demerara, in 1821.

1825.
Jan. 8.

Dr Knox read a short communication, shewing that the bones found in a bed of clay near Camelon, and ninety feet above the present level of the Forth, were those of a full grown seal, of the species still inhabiting the Frith of Forth. The first part of Dr Richardson's Remarks on the Climate and Vegetable Productions of the Hudson's Bay Countries, was then read.

Jan. 22.

The Secretary read Dr Richardson's Observations on the

Climate at Fort Enterprize, Lat. $64^{\circ} 28' N.$, Long. $116^{\circ} 6' W.$; with an Account of the Progress of Spring and Summer, at that station, in the year 1821. Dr Greville read extracts from, and gave a general account of, the third memoir, by himself and Mr Arnott, on a New Arrangement of the Musci. The Secretary then read an Account of a New Species of Ornithorynchus (*O. crispus*), by Mr Macgillivray; specimens of this, and the other species, being, at the same time, placed on the table. Professor Jameson gave an Account of the Sea-Leopard; an animal of the genus *Phoca*, from the lately discovered islands of New South Orkney; and of the Eared Seal from New South Shetland; both animals brought home by Captain Weddel.

The Secretary read the concluding part of Dr Richardson's Observations on the Botany of the Hudson's Bay Countries. Mr Witham read a Notice of the occurrence, in Primitive rocks, in Ross-shire, of Mineral Pitch, which has hitherto been observed associated only with secondary rocks; specimens were also laid upon the table. The Secretary read Mr John Baird's Account of Fossil Trees, found in Secondary Trap-rocks, at Cleghorn, in Lanarkshire; and specimens were likewise produced. Professor Jameson read a communication from Mr A. Blackadder, Allan Park, tending to shew that the Rhinoceros Horns of Blair-Drummond may probably be regarded as having occurred in the blue clay of that district. Professor Jameson also read an Account, communicated by Mr David Mylne, of some remarkable Fossilized Trunks and Branches of Trees, found in a quarry near Coldstream; and fine Specimens of these were exhibited. Mr David Blackadder, of Edinburgh, laid before the meeting samples from Blair-Drummond Moss, *1st*, Of the peat beneath the blue clay; *2d*, Of the clay itself; and, *3d*, Of the surface peat.

1825.
Feb. 5.

1825.
Feb. 19.

The Secretary gave a General Account, *1st*, Of Tables of Summer Temperature observed in Spitzbergen, by Captain Franklin and Captain Buchan ; and, *2dly*, Of a Table of the Temperature of the Sea, at various depths, made during Capt. Franklin's voyage to Spitzbergen. There was then read a Notice in regard to the Fossil Trees, &c. found imbedded in the clay strata near Harwich, contained in a letter from Mr William Knott, Landguard Fort ; and a specimen of the fossil wood was exhibited. Likewise a Notice in regard to a collection of Buried Trees, apparently native kinds, lately found in draining a peat-moss in West Lothian ; in a letter from Mr Logan of Clarkstone to Mr A. Blackadder. Observations made during a voyage to the East Indies and China, in 1817 and 1818, by Captain Charles Stewart of the Honourable East India Company's ship General Harris, were laid on the table. Professor Jameson gave an Account of a Specimen of a Large Fossil Tree lately dug out of the Coal Formation at Cullalo, in Fyfe, which was exhibited to the meeting. Dr Grant then read the first part of a Memoir containing a series of Observations and Experiments on the Natural History of Sponges, which he illustrated by Specimens.

Mar. 5.

Professor Jameson read the Reverend George Young's Account of the remains of a genuine though extinct species of Crocodile, 18 feet long, lately found imbedded in the secondary rocks at Whitby in Yorkshire ; and, at the same time, exhibited a correct Drawing of it, executed by Mr Bird. Dr Grant read the conclusion of his first Memoir, containing a series of Observations and Experiments on the Natural History of Sponges. A fine Specimen of Organic Vegetable Remains, found in Craig-Leith quarry, was exhibited and described by Professor Jameson.

The Secretary read a Notice of the effects produced by the presence of the Larva of an Insect in the Human Stomach; communicated by Dr Yule. He then gave an Account of Mr George Cheyne's Journal from Madeira to Lat. $18^{\circ} 06'$ N. and Long. $38^{\circ} 20'$ W., and presented to the meeting a commentary on the Second Book of the Herbarium Amboinense, by Dr Francis Hamilton. A letter from Mr James Fotheringham, Gairny Bridge, was then read, giving a general Account of the Shower of Fishes supposed to have fallen in the west of Fifeshire last summer. Mr Deuchar exhibited a very singular experiment with compressed inflammable gas; and likewise the application of Mr Gordon's portable lamp apparatus as a blowpipe.

1825.
Mar. 19.

The Secretary read a Notice regarding Specimens of Peat Moss, of different qualities and densities, from a moss at Jardine-Hall, Dumfries-shire. Likewise a short Notice regarding the Magnetism of the Earth, by the late Lieutenant Mathew Miller; which Mr Adie illustrated by an experiment, shewing the effect of Magnetic Bars, placed with N. and S. ends together, upon a compass passed over them. Professor Jameson read an Account of the recent discovery of a Tusk of the Mammoth, in a bed of old alluvium, containing also Marine Shells, and situated near to Kilmarnock, in Ayrshire. Dr Grant then read an Account of a Particular Organ, observed by him in the cuttle-fish (*Sepia loligo*), and which he regards as analogous to the pancreas: Specimens were also laid on the table.

April 2.

There was laid before the meeting a Description and Drawing of a Species of Cephalus, nearly allied to *Tetrodon truncatus* of Cuvier; communicated by Dr Traill of Liverpool. Professor Jameson communicated to the So-

April 16.

ciety Mr David Mylne's Descriptive Account of the Stratification on the right bank of the Whitadder. Dr Grierson of Cockpen read his Account of the Explosion of Stobbs Gunpowder Mills, on the 17th of February last : And the Secretary read a short Additional Notice by Mr Hutcheson of Dalkeith Mills, communicated by Mr Burd. The Secretary then read Mr Alexander Blackadder's Report regarding the Buried Forest of Lawrence Park, near Linlithgow. Mr Deuchar communicated his Observations on Magnetic stimuli ; illustrating some of his remarks by repeating several of Professor Oersted's experiments. There were exhibited by Professor Jameson to the meeting, *1st*, The cast of a remarkable and supposed Antediluvian Skull ; *2dly*, The cast of a Jaw-bone of the Mammoth,—both from the Great Valley of Austria ; *3dly*, Two Specimens of the Ancient Bricks of Babylon, containing inscriptions in an unknown character.

1825.
April 30.

Dr Grant read a Paper on the Existence of a Pancreas in Gasteropodous Animals, and shewed dissected Specimens of the Doris Argo, with the pancreas pointed out. The Secretary then read a communication from Mr Blackadder, staff-assistant surgeon, on Unusual Atmospherical Refraction, or Misage, as observed in this neighbourhood ; and laid before the meeting some Account of Capt. Franklin's Trigonometrical Observations made in India. Dr Greville gave an Account of Two New Species of Musci, of the genera Neckera and Hypnum.

May 14.

Mr Haidinger read a Paper on Drawing the Figures of Crystals in True Perspective. The Secretary read Mr Blackadder's Account of the Luminous Arch which lately accompanied the appearance of the Aurora Borealis at

Edinburgh. Dr Knox exhibited Bones of Various Animals, found in the Caves of Oreston, near Plymouth, being chiefly bones of large oxen and very large deer. A letter from Henry Home Drummond, Esq. M. P. was then read, accompanied by a plug of wood, which was found inserted in a circular perforation existing in the great stag's horn discovered in the Blair-Drummond peat moss, and which would intimate that the stag had been in the hands of the former inhabitants of the district. Professor Jameson gave a general account of a long communication received from a correspondent, on the chances for and against Captain Parry's succeeding in his present attempt to reach the South Sea, by Icy Cape; the opinions of the author being unfavourable to his success. He also exhibited the tusk of the Fossil Elephant or Mammoth lately found near Kilmarnock.

Mr Witham read a Notice of the occurrence of the Common Cockle (*Cardium edule*) in a living state, in Fresh Water Ditches, at Cocklesbury, in Yorkshire, at a great distance from the sea, and much above its present level. A Memoir by Mr David Don, on the Classification of the genera *Gnaphalium* and *Xeranthemum* of Linnæus, was laid on the table. There was then read the first part of a sketch of the Comparative Anatomy of the Organ of Hearing, containing Remarks on the Structure of the Ear in the Shark-tribe, illustrated by Preserved Specimens; by Mr Thomas Buchanan. There was next read a communication regarding the existence of a Rock of Conglomerate in the Gravel Beds near Edinburgh; and Specimens of the rock were exhibited. Professor Jameson gave an Account of a Table of Colours, arranged for Naturalists, by the Reverend Lansdown Guilding of St Vincent's.

1825.
Nov. 19

1825.
Dec. 3.

The Secretary read Dr Traill's Remarks on the Anatomy of the Trumpeter Bird, *Psophia crepitans*. Dr Grant then made some Observations on the Habits of the *Tritonia arborescens*, particularly the power possessed by that animal of producing a peculiar and very audible sound; and at the same time exhibited living Specimens. Prof. Jameson communicated some Remarks on the existence of many Mineral Substances, in very minute quantities, in the Ocean and in the Atmosphere. He then laid before the meeting a Letter from Count Sternberg, accompanied with a New Fasciculus of his Work on Fossil Remains of Plants. And the Secretary read a Letter from Dr J. Miller of Kingston, Jamaica, expressing the wish of the Agricultural Society of Jamaica to correspond with the Wernerian Society; to which the Secretary was authorised to reply, assuring the Jamaica Society that it will afford this Society much satisfaction to be able, in any way, to promote the objects of the Jamaica Institution.

Dec. 17.

The Secretary read a Paper by Mr John Murray, Lecturer on Chemistry, containing Experiments and Observations on the varying Temperature of the Chameleon, as connected with the Changes of Colour exhibited by the animal. Professor Jameson communicated a Notice of Zircon found in Primitive Rocks in the Island of Scalpay, Harris; by Mr William Nicol, Lecturer on Natural Philosophy. The Secretary then read a Notice by Mr P. J. Selby, regarding a specimen of the rare *Larus minutus*, shot in Galloway, and sent to the Museum by Lieutenant Macculloch, Barholm House. Likewise a communication from Dr Traill regarding the use of Oil of Turpentine for preserving Zoological Specimens in Cabinets: This substance, it was stated by Professor Jameson, had been em-

ployed, for several years past, in the Museum here, with the same view, and with great success. Professor Jameson then read the first part of Mr William Macgillivray's Account of the Animals of the classes Cirripeda, Conchifera, and Mollusca, observed in the Island of Harris. And he also communicated a Letter from Mr Meynell, of Yarm, in Yorkshire, mentioning that he had, for four years past, kept the smelt or spirling (*Salmo Eperlanus*, LIN.), in a fresh-water pond, having no communication with the sea, by means of the Tees, or otherwise, and that the smelts had continued to thrive, and breed as freely, as when they enjoy intercourse with the sea.

OFFICE-BEARERS, 1826.

Office-bearers elected at the Meeting on 3d December 1825.

President,

ROBERT JAMESON, Esq. Prof. Nat. Hist. Edin. &c.

Vice-Presidents,

ROBERT BALD, Esq.		Dr ROBERT GRAHAM,
Sir WM. JARDINE, Bart.		Rev. Dr BRUNTON.

Secretary, PATRICK NEILL, Esq.

Treasurer, A. G. ELLIS, Esq.

Librarian, JAMES WILSON, Esq.

Painter, P. SYME, Esq.

Council.

WILLIAM DRYSDALE, Esq.		Dr ANDREW COVENTRY.
GILBERT INNES, Esq.		JOHN STARK, Esq.
Dr ROBERT KNOX.		Dr R. E. GRANT.
G. A. W. ARNOTT, Esq.		Dr JOHN BOGGIE.

List of Members of the Wernerian Natural History Society of Edinburgh,—continued from Vol. IV.

RESIDENT.

1823.

- Nov. 29. JOHN ALEXANDER CAMERON, Esq. Edinburgh.
 HENRY WITHAM, Esq. of Lartington.
 EDWARD WILLIAM AURIOL HAY, Esq. A. B. Oxon.
 The Rev. ALEXANDER BRUNTON, D. D. Professor of Oriental Languages in the University of Edinburgh.

1824.

- Jan. 10. THOMAS ALEXANDER FRASER of Lovat, Esq.
 CHARLES MACALISTER, Esq.
 JOHN WILSON ANDERSON, Esq.
 WILLIAM DUNLOP, Esq. Surgeon, and Lecturer on Forensic Medicine.
 April 3. JAMES SYME, Esq. Surgeon, and Lecturer on Anatomy, Edinburgh.

1825.

- Feb. 5. HENRY ENGLEFIELD, Esq.
 WILLIAM GIBSON THOMSON, Esq.

NON-RESIDENT.

1824.

- Feb. 7. Sir WILLIAM PURVIS HUME CAMPBELL, Bart.
RICHARD DOBSON, M. D.
- April 3. JOHN EDWARDS, Esq. Surgeon.
- Dec. 18. Sir DAVID MONCREIFFE, Bart. of Moncreiffe
House.
JACOB VERZFELD, Esq. of Cape Town.

1825.

- Feb. 5. COLIN ROGERS, M. D.
RICHARD DAVIE, Esq.
JOSEPH MITCHELL, Esq. General Superintendant
of Parliamentary Roads in the Highlands of
of Scotland.
- May 14. JAMES B. KIRK, M. D. of Greenock.
JAMES WOODFORD, M. D.

FOREIGN.

1823.

- April 26. M. NORDENSKIOLD of Abo, in Finland.
- Nov. 29. The Rev. THOMAS MACCULLOCH of Pictou,
Nova Scotia.

1824.

- April 3. Professor REICHENBACH of Dresden.
- Dec. 18. Professor KEYSER of Christiania.

1825.

- Feb. 5. Professor HANSTEEN of Christiania.
Professor RATHKE of Christiania.

CORRESPONDING.

1823.

Nov. 29. Mr WILLIAM MACGILLIVRAY, Edinburgh.

1824.

Jan. 10. The Rev. WILLIAM DUNBAR of Applegarth.

THOMAS HORTON JAMES, Esq. London.

May 15. THOMAS BARNES, M. D. Carlisle.



INDEX

TO

VOLUME FIFTH.

A

	Page
AFRICA, Southern, Dr Knox's inquiry into the origin and characteristic differences of the native Races inhabiting, p. 206 ; three distinct races, 207 ; Anglo-Dutch colony intruders, 207 ; Hottentots, or Bosjesmans, 207 ; Damaras, 207 ; Kaffres, 208 ; Kaffre nations referred to the Ethiopian race, 210 ; Bosjesman nations referred to the Mongolic, 210 ; comparative table of the characters of the Negro and Kaffre, 211 ; table of the characters of the Mongol and Bosjesman, 214 ; comparative measurements of the head in several varieties of the human species, - - - - -	218
Anictangium, generic characters of, - - - - -	61
Animals collected on Captain Franklin's Expedition, Dr Richardson's account of the, - - - - -	568
Antennaria, generic characters of, - - - - -	28
Arnott, G. A. W. Esq. his account of several species of Hepaticæ from Rio de Janeiro, 204—Notice of Mr Jameson's Journal of a voyage from Rio de Janeiro to the coast of Peru, 187—Account of two species of Lycopodineæ, from Rio de Janeiro, 199—New arrangement of the genera of Mosses, 42 ; continued, 442—Account of several species of Musci found at Rio de Janeiro, - - - - -	200

Astelma, generic characters of, - - -	542
Atkinson, J. Esq. his sketch of the geographical distribution of plants in Yorkshire, - - -	277
Atmospherical refraction, Mr Blackadder's account of unusual, - - - - -	576
Auk, black-billed, Mr Edmondston's observations on it, 8—identical with <i>Alca torda</i> , 13—account of its habits,	22
Aurora borealis, Mr Blackadder's account of the luminous arch accompanying its appearance, - - -	576

B

Bees, Rev. Mr Dunbar, on the conversion of working into Queens, - - - - -	566
Blackadder, Alexander, Esq. on the superficial strata of the Forth District, 424—on the bones of whales discovered in the upper district of the Forth, - - -	437
Bones, Mr Blackadder's notice regarding those of a whale found in the upper district of the Forth, - - -	ib.
— fossil, of a whale, discovered in the district of Monteth, Mr Drummond's notice regarding, - - -	440
— of a quadruped found near Falkirk, Mr Reddoch's notice regarding, 572—Dr Knox's determination of the species to which they belonged, - - -	572
Bosjesmans, one of the races inhabiting Southern Africa, 207—their characters compared with those of the true Mongols, - - - - -	214
Boué, Dr, his answer to Mr Beudant's opinions regarding the crystalline rocks of the Red sandstone, - - -	566
Bryum argenteum, turbinatum, and roseum, described, - - -	201
Buried trees found in West Lothian, Mr Logan's account of,	574
Buxbaumia, generic characters of, - - -	79
Buxbaumioideæ, characters of the family of, - - -	72

C

Carpholoma, generic characters, and description of a species of, - - - - -	555
--	-----

	Page
Chameleon, Mr J. Murray's experiments and observations on its temperature, as connected with the changes of its colour, - - - - -	578
Chardinia, generic characters of, - - - - -	540
Chronometers, table of the daily differences, and rates of three, on a voyage from Rio de Janeiro to the coast of Peru, - - - - -	194
Cochlea of the ear of birds, Dr Treviranus's communication on the, - - - - -	572
Cockle, common, Mr Witham's notice regarding its occurrence in fresh water ditches in Yorkshire, - - - - -	577
Coco-nut tree, Mr Marshall's contribution to its natural and economical history, 107—Its description, 107—Supposed medical uses, 110—Habitat and distribution, 112—Synonyms, 115—Uses, 116—Mode of extracting toddy from the flower, 122—Distillation of arrack from the juice, 126—Extraction of sugar, 128—Manufacture of coir, 134—Coco-oil, - - - - -	138
Coldstream, Mr John, his thermometrical observations made hourly at Leith, during twenty-four successive hours, and once every month, from July 1822 to July 1823, - - - - -	175
Colours, Rev. L. Guilding's table of, - - - - -	577
Conchiferous animals observed in Harris, - - - - -	579
Coregonus albus, described, - - - - -	510
----- Artedi, described, - - - - -	515
Corfu, Mr Miller's register of the weather at, during part of 1821, - - - - -	90
Cork, Rev. D. Guilding's notice of a substitute for it, - - - - -	570
Crocodile, Rev. G. Young's account of one found in secondary rocks at Whitby, - - - - -	574
Crystals, Mr Haidinger's account of the method of drawing them in true perspective, 485—Excellence of Häüy's figures, 486—The method developed is that followed by Mohs, 486—General principles, 487—Projections of simple forms, 488—Method of drawing a hexahedron, 488—A regular octahedron, 491—A given	

- isosceles four-sided pyramid, 491—The pyramid (P)³ of pyramidal zircon, 492—Scalene four-sided pyramid, 494—Right rhombic prism, 494—Regular six-sided prism, 495—Regular six-sided prism, whose lateral planes are squares, 495—Regular six-sided prism, whose sides are squares, 496—Rhombohedron, 499—Scalene six-sided pyramid, 500—Projections of compound forms, 501—Combination of the hexahedron and octahedron, 501—Rhombohedral combination R. (P)³. R + 2, of the species of rhombohedral lime-haloide, 503—The pyramidal combination P. (P)³. $\frac{3}{2\sqrt{2}}$ P + 3. P + ∞, of the species of pyramidal zircon, - 505

D

- Dempster, William, Dr Barnes's account of his swallowing a table-knife, - - - - - 570
 Dicranum bryoides, flexuosum, and cirrhatum, described, 201
 Diphyscium, generic characters of, - - - - - 73
 Dissodon, generic characters of, - - - - - 461
 Diver, red-throated, its bones of a dark colour, - 570
 Don, Mr David, his classification of the genera Gnaphalium and Xeranthemum of Linnæus, 533—Monograph of the genus Pyrola, - - - - - 220
 Drawing crystals in true perspective, Mr Haidinger's account of the method of, - - - - - 485
 Drummond, Henry Home, Esq. his notice regarding bones of a whale discovered in the district of Monteith, - 440

E

- Edmondston, Laurence, Esq. his observations on the Lesser Guillemot and Black-billed Auk, proving them to be identical with the Foolish Guillemot and Common Auk, - - - - - 8
 Explosion of Stobbs Gunpowder Mills, Dr Grierson's account of the, 576—Additional notice regarding it, - 576

F

- Fishes observed during Captain Franklin and Dr Richardson's Journey to the Polar Sea, Dr Richardson's account of some, 509—*Coregonus albus*, 510—*Coregonus Arctedi*, 515—*Hiodon clodalis*, - - - - 518
- Mr J. Fotheringham's account of a shower of, supposed to have fallen in Fifeshire, - - - - 575
- Fleming, Dr John, his description of a new species of *Plumularia*, from the Arctic Expedition, 303—Account of a new British species of *Spatangus*, - - - - 287
- Fontinalis squamosa*, a variety of it described, - - - - 204
- Foramen centrale of the Retina, Dr Knox's account of it as seen in reptiles, 1—in *Lacerta superciliosa*, 4—*L. scutata*, 6—*L. calotes*, 6—Chameleon, - - - - 104
- Forth district, Mr Blackadder, on the superficial strata of the, 424—Upper district, 425—Lower district, 426—Clay of this district described, 425—Peat-mosses, 426—Vegetable remains found in the clay, 427—Description of the strata, 428—Sand and gravel deposits on the margin of the carse-clay of the lower district, 429—Sands and gravel of the upper district, 432—Old red sandstone of the upper district, 434—Bones of whales discovered in the upper district, - - - - 437
- Fossil bones of a whale discovered in the district of Monteth, Mr Drummond's notice regarding, - - - - 440
- shells, Mr Vaysey's account of some found in the Gawilghur Range in India, 289—Geological nature of the Range, 290—The only remains of animals discovered in India, have been found in trap rocks, - - - - 296
- tree found at Cullalo, in Fifeshire, - - - - 574
- trees found near Harwich, Mr W. Knott's notice of, 574—Found in trap rocks in Lanarkshire, Mr J. Baird's account of, - - - - 573
- trunks and branches found near Coldstream, Mr D. Mylne's account of, - - - - 573

- Frog, Mr Burd's notice respecting an instance of mis-directed instinct in it, - - - 567
- Fruit-trees, Mr Stevenson on the prejudicial effects of a layer of bog iron-ore upon, - - - 571

G

- Gawilghur Range of Hills, Mr Vaysey's account of some fossil shells found in it, 289—Geographical account of these hills, 289—Of the newest Flœtz Trap Formation, 290—Results of their investigation, 290—The principal part compact basalt, 290—Wacke, 291—Nodular wacke or basalt, 291—Columnar basalt, 291—Simple minerals contained in the wacke, 293—The shells belong either to the genus *Conus* or *Voluta*, and are flattened, 295—The rocks containing them inferred to be of igneous origin, - - - 296
- Geology and Geognosy, Dr Grierson's general observations on their nature, 401—Account of the principal theories of geologists, 403—Huttonian theory, 405—Wernerian theory, 407—Legitimate objects of Mineralogy and Geology, 408—The term Geognosy introduced by Werner, to distinguish the truly useful from the merely speculative part of mineralogy, - 409
- Gnaphalium and Xeranthemum of Linnæus, Mr Don's memoir on the classification and division of, 533—Remarks illustrative of the family of *Compositæ*, 534—Characters of the genus *Xeranthemum*, 538—*Chardinia*, 539—*Leucostemma*, 540—*Astelma*, 542—*Aphelexis*, 546—*Euchloris*, 548—*Helichrysum*, 549—*Pentataxis*, 550—*Spiralepsis*, 551—*Petalacte*, 552—*Phænocoma*, 554—*Carpholoma*, 555—*Metalasia*, 556—*Antennaria*, 560—*Leontopodon*, 561—*Gnaphalium*, 563—Characters of the genus, - - - 563
- Greville, Robert Kaye, Esq. his new Arrangement of the Genera of Mosses, 42—continued, 442.—Descriptions of two new species of Mosses from America, 481—*Addendum*, - - - 564

	Page
Grierson, Rev. Dr. his observations on Geology and Geognosy, - - - - -	401
Guillemot, Lesser, Mr Edmondston's observations on it, 8—Identical with the Foolish Guillemot, 13—Account of its habits, - - - - -	22
Gymnostoideæ, characters of the families of, - - - - -	42
Gymnostomum, characters of the genus, 43—G. Jamesoni described, - - - - -	200

H

Haidinger, W. Esq. his account of the method of drawing crystals in true Perspective, - - - - -	485
Hamilton, Dr Francis, his Commentary on the Herbarium Amboinense of Rumphius, - - - - -	307
Head, measurement of it, in several varieties of the human race, - - - - -	218
Hedwigia, generic characters of, - - - - -	67
Helichrysum, generic characters of, - - - - -	545
Hepaticæ, description of four species of, from Rio de Janeiro, - - - - -	204
Herbarium Amboinense, Dr Francis Hamilton's Commentary on the, 307—Palma Indica major, or Cocos nucifera, 307—Pinanga domestica, or Areca catechu, 307—Pinangæ sylvestres, various species of Areca, 308—Saribus, Corypha rotundifolia, Encyclopedie, 312—Limalia arbor, Licualia spinosa, Willd. 312—Description of Licualia peltata, 313—Lontarus domestica, 314—L. sylvestris, 314—L. sylvestris Yhur dicta, 315—L. sylvestris Eabang, 315—L. sylvestris altera, 315—Palma indica vinaria secunda, 315—Arbor Tsiang, 316—Seguaster major, 316—S. minor, 316—Description of Hauria caryotoides, 317—Nypha, or Nipa fruticans, Willd. 318—Sagus seu Palma farinaria, 318—S. genuina, or Sagus Rumphii, Willd. 319—Sagus sylvestris, S. longissima, S. lævis, S. filaris, 320—Bisula, 320—Olus calappoides, 321—O. calappoides e Celebe, ut et	

illa ex Insulis Ulasseriensibus, 323—Planta Pappa dicta, 324—Arbor calappoides sinensis, 324—Manga domestica, or Mangifera indica, Linn. 325—Manga Pau-marga sylvestris, 325—Manga fœtida, 327—Durio, or Durio zibethinus, 327—Saccus arboreus major, Tsjaca Maram. Hort. Mal. 327—Saccus arboreus minor, 328—Angelyquen vel Caju Bandaa, 329—Soccus lanosus, S. granosus, S. sylvestris, 332—S. sylvestris celebica, S. sylvestris fœmina, 333—Prunum stellatum angulosum, 334—Blimbingium teres, 335—Jambosa domestica, 335—Jambo d'Agoa Rosada, 336—Jambosa nigra, J. aquea, 336—J. sylvestris alba Utan Puti, J. sylvestris alba Biawas, J. sylvestris parvifolia, 337—J. sylvestris, Jamboe Ayer Utan dicta, 338—J. ceramica, 339—J. sylvestris Lahunensis, 341—Jambolana, 341—Mangostana, M. celebica, 343—Arbor Mundo dicta, 345—Anona, 348—Fructus Chinensis Khi dicta, 352—Anona tuberosa, 352—Cujavus domestica, C. agrestis, 352—C. sylvestris, 353—Cujavillus, 353—Papajamas et femina, P. sylvestris, P. litorea, 354—P. Atehu, 355—Lansium domesticum album et rubrum, L. sylvestre primum et secundum, L. montanum, 355—Cusambium, 356—Linkeng, 358—Pomum draconum domesticum, P. draconum sylvestre, 358—Rau Genrang, 358—Condondum, 358—Condondum Malaccense, 359—Cynomorium, C. sylvestre, 359—Sandoricum domesticum, S. sylvestre, 360—Cajim-gulur, 361—Sajanus, 361—Atunus, 362—Atun Puti, 362—Vidoricum domesticum, V. sylvestre primum, 362—Catappa domestica, C. litorea, C. sylvestris, 363—Cassuvium, 177—Cassuvium sylvestre, 365—Gnemon domestica mas et femina, G. sylvestris, 367—Morunga mas et femina, 368—Turia, 373—Turia rubra, T. striata, 374—Tæri mera, 374—Olus album domesticum, O. album insulare, 375—Utta pela seu Sagor Bagnala, 376—Eriophoros Javana, 376—Bilacus Tellor, 378—Bilacus Madia Pissang, B. taurinus, B. Amboinensis sylvestris, 382

Hippophagi, Mongol and Bosjeman races strictly merit the appellation of,	- 216
History of the Society,	- 565
Hookeria tomentosa, albicans, prolonga, described,	- 202
Hudson's Bay countries, Dr Richardson's remarks on their climate and vegetable productions,	- 572
Hypnum loxense, imbricatum, minutulum, subsecundum, amœnum, described,	- 203
—— remotifolium, a new species, described,	- 483

J

Jameson, Mr W. notice of a Journal of a voyage from Rio de Janeiro to the coast of Peru, by him,	- 187
Journal of a voyage from Rio de Janeiro to the coast of Peru, by Mr William Jameson, Mr Arnott's notice of it, 187—Meteorological journal kept on the voyage, 192—Table of the daily differences and rates of three chronometers, 194—Account of mosses, &c. collected at Rio de Janeiro, 199—Lycopodineæ, Lycopodium rupestre, and convolutum, 199—Musci, Gymnostomum Jamesoni, Dicranum bryoides, D. flexuosum, Tortula cirrhata, Bryum argenteum, turbinatum and roseum, Orthotrichum Jamesoni, Hookeria affinis, Hookeria prolonga, Hypnum loxense, imbricatum, minutulum, subsecundum, and amœnum, and Fontinalis squamosa, 200—Hepaticæ, Jungermannia, patula, brachiata, Tamarisci, platyphylla, and multifida,	- 204
Juncus lampocarpus, Mr Parry's notice regarding a viviparous variety of,	- 571
Jungermannia, several species of, described,	- 204

K

Kaffre, characters of the, compared with those of the Negro,	211
Knox, Dr Robert, his account of the Foramen centrale of the Retina, as seen in the eyes of certain reptiles, 1—Additional observations on the same subject, 104—	

Observations on the anatomy of the *Ornithorynchus paradoxus*, 26, 144, 151, 161—Inquiry into the origin and differences of the native races inhabiting Southern Africa, 206—On the mode of growth, reproduction and structure of the poison-fangs in serpents, - 411

L

- Larus*, Mr Macgillivray's descriptions, characters and synonyms of the different species of the genus, 247—General remarks, 247—Generic characters, 248—*Larus bathyrinchus*, 253—*L. marinus*, 255—*L. fuscus*, 260—*L. argenteus*, 264—*L. arcticus*, 268—*L. glacialis*, 270—*— minutus*, Mr Selby's account of one shot in Galloway, - 578
- Larva, Dr Yule's account of the effects produced by the presence of one in the human stomach, - 575
- Leontopodon, characters of the genus, - 561
- Leucostemma, characters of the genus, - 540
- Lycopodineæ, description of two species of, - 199
- Lycopodium rupestre* and *convolutum* described, - 199

M

- Macgillivray, Mr W. his monograph of the genus *Larus*, 247
- Magnetic stimuli, Mr Deuchar's observations on, - 576
- Magnetism of the Earth, Mr M. Miller's notice regarding it, - 575
- Mammoth tusk found near Kilmarnock, - 575
- Marshall, Mr Henry, his contribution to the natural and economical history of the Coco-nut Tree, - 107
- Members of the Society, list of, - 581
- Mermaid, deposition of three Shetland fishermen respecting one, - 569
- Metalasia, generic characters of, - 556
- Meteoric stones, Mr Deuchar's remarks on, - 560
- Meteorological Journal, kept on a voyage from Rio de Janeiro to the coast of Peru, - 192
- Migration of the Golden-crested *Régulus*, Mr Selby's observations on the, - 397

- Miller, Mathew, Esq. his register of the weather at Corfu, during part of 1821, - 90
- Mineral pitch, Mr Witham's account of its occurrence in Ross-shire, - 573
- Mongol, characters of the, compared with those of the Bosjeman, - 214
- Mosses, Messrs Greville and Arnott's New Arrangement of the Genera of, 42—Characters of the Gymnostomoidæ, 42—Of the genus *Gymnostomum*, 43—*Schistostega*, 55—*Anictangium*, 61—*Hedwigia*, 67—*Buxbaumioideæ*, 72—*Diphyschium*, 73—*Buxbaumia*, 79—Subject continued, 442—*Splachnoideæ*, 442—*Splachnum*, 448—*Dissodon*, 461—*Tayloria*, - 470
- Murray, John, Esq. his observations on the ascent of the Spider into the atmosphere, - 384
- Musci, Mr Arnott's account of several species of, from Rio de Janeiro, 200—Dr Greville's description of two new species from America, - 481

N

- Neckera americana*, a new species, described, 481—Not new, but found to be *N. minor*, Schwægr. - 564
- Neckera undulata* described, - 202
- Negro, characters of the, compared with those of the Kaffre, 211
- Newfoundland, account of Mr Cormack's journey across it, 567
- Noble, Mary, Dr Barnes's biographical account of, - 565

O

- Office-bearers for 1823-4-5, list of, - 582
- Organ of hearing in the Shark tribe, Mr Buchanan's account of it, - 577
- Ornithorynchus paradoxus*, Dr Knox's observations on its anatomy, 26—Organs of sense described, 26—Poison-gland and spur, 37—Organs of digestion, respiration, and circulation, 144—Kidneys, urinary bladder, and organs of generation, 151—Osseous, muscular and nervous systems, - 161

- Ornithorynchus, a new species of it described, - 573
 Orthotrichum Jamesoni described, - 201

P

- Pancreas, Dr Grant's account of its occurrence in Sepia
 Loligo, 575—In gasteropodous animals, - 576
 Pentataxis, generic characters of, - 550
 Petalacte, generic characters of, - 552
 Phænocoma, generic characters of, - 554
 Plantations, Mr Parry on the management of young, - 569
 Plants, Mr Atkinson's sketch of the geographical distribution of, in Yorkshire, 277—General observations, 277
 Enumeration of particular species, - 278
 Plumularia bullata, Dr Fleming's description of, - 308
 Psophia crepitans, Dr Traill's observations on its habits, appearance, and anatomical structure, 523—Description, 524—Erroneously placed among the Gallinaceæ, 526—Intestinal canal, *ib.*—Lungs, *ib.*—Cry described, 527—Specific name absurd, and proposed to be altered into Loricata or Clypeata, 527—Psophia a true ventri-
 loquist, 527—Trachea described, - 528
 Pyrola, Mr Don's monograph of the genus, 220—General observations, 220—Generic character, 224—Conspectus of the species, 225—*P. rotundifolia*, 228—*P. asari-
 folia*, 230—*P. chlorantha*, 231—*P. occidentalis*, 232—
P. dentata, *P. picta*, 235—*P. aphylla*, 237—*P. media*,
 238—*P. minor*, 239—*P. secunda*, 241—*P. uniflora*, 242
 —*P. umbellata*, 243—*P. maculata*, 244—*P. Menziesii*, 245

Q

- Quadrupeds of Hudson's Bay, Dr Richardson's account of
 the, - 568

R

- Races inhabiting Southern Africa, Dr Knox's inquiry into
 their origin and differences, - 206

- Register of the weather at Corfu, during part of 1821, - 90
- Regulus, Golden-crested, Mr Selby's observations on its migrations, 397—Its arrival on the coast, from Berwick to Whitby, along with Thrushes and Woodcocks, 398—Disappeared entirely in the winter of 1822, 399—Not seen in Scotland in the summer of 1823, - 399
- Reptiles, existence of the foramen centrale of the retina in certain species of, 1—In *Lacerta superciliosa*, 4—*L. scutata*, 6—*L. calotes*, 6—Chameleon, - 104
- Retina, Dr Knox's account of the discovery of the foramen centrale of the, in the eyes of reptiles, - 1
- Rhinoceros horns of Blair-Drummond, Mr Blackadder's communication regarding them, - 573
- Richardson, Dr John, his account of some fishes observed during Captain Franklin's journey to the polar sea, - 509

S

- Schistostega, description of the genus, - 55
- Sea-devil, Mr Lamont's account of the capture of one in the West Indies, - 568
- Seetabuldee, a hill in India, Mr Vaysey's account of its geological structure, - 298
- Selby, P. J. Esq. his observations on the migrations of the Golden-crested Regulus, - 397
- Serpents, Dr Knox on the mode of growth, reproduction and structure of the poison-fangs, 41—Observations on the simple teeth of serpents, 412—the fangs, 415—A single fixed one only, in general, on each side, 415—Progressive growth of the fangs, - 416
- Shells, Mr Vaysey's account of some fossil ones found in the Gawilghur Range in India, - 289
- Silurus Parkeri, described by Dr Traill, - 572
- Skull, supposed antediluvian, - 576
- Smelts kept for four years in fresh water, - 579
- Spatangus, Dr Fleming's account of a new British species of, 287
- Spider, Mr Murray, on the power possessed by it of propelling its threads, and ascending into the air, 384—

- General remarks, 384—Gossamer, 385—Shower of spider's webs, 387—*Aranea aëronautica* described, 387—Remarks on *Aranea geometrica*, 388—Atmosphere full of cobwebs, 388—Fall of *A. aëronautica* after a discharge of fire-arms, 389—Experiment on spiders, 389—Propulsion of the thread, 390—Thread electrified, 391—Various experiments and observations on the subject, - 392
- Spiralepis*, generic characters of, - 551
- Splachnoideæ*, characters of the family of, - 442
- Splachnum*, generic characters of, - 448
- Sponges, Dr Grant's memoir on the natural history of, - 574
- Stone-axe, account of one said to have been found imbedded in compact clay under limestone, - 567

T

- Tallow-candles, Dr Yule's account of the changes produced in, - 567
- Tayloria*, characters of the genus, - 470
- Thermometrical observations made hourly at Leith, during twenty-four successive hours, and once every month, from July 1822 to July 1823, Mr John Coldstream's, - 175
- Toad imprisoned for fifty-four years, Major-General Hardwick's account of one, - 571
- Tortula cirrhata* described, - 201
- Traill, Dr Thomas Stewart, his observations on the habits, appearance and structure of the *Psophia crepitans*, - 523
- Trap Rocks of the counties of York, Durham, Westmoreland, Cumberland, and Northumberland, Mr Witham's notice regarding the, 475—Opinions respecting the origin of trap, 475—Strata of Derbyshire, 476—Description of the trap rocks in question, - 477
- Tritonia arborescens*, Dr Grant's observations on its habits, 578
- Trumpeter, Dr Traill's observations on its habits, appearance and structure, - 523
- Turpentine, rectified oil of, Dr Traill's communication regarding its use for preserving zoological specimens, - 578

V

- Vaysey, H. W. Esq. his account of some fossil shells found in the Gawilghur Range, 289—Account of the geological structure of the hill of Seetabuldee, Nagpoor, and its immediate vicinity, - - 298
 Vegetable remains found in Craig-Leith Quarry, - 574

W

- Weather, Mr Miller's register of it, at Corfu, during part of 1821, - - - 90
 Whale, Mr H. Drummond's notice regarding bones of one discovered in the district of Monteith, 440—Mr Blackadder's notice regarding bones of one, discovered in the upper district of the Forth, - - 437
 Whitadder, Mr D. Mylne's account of the stratification on its right bank, - - - 576
 Witham, Henry, Esq. his notice regarding the trap rocks of the counties of York, Durham, Westmoreland, Cumberland, and Northumberland, 475—Regarding live cockles found in fresh-water ditches, - 577

X

- Xeranthemum and Gnaphalium of Linnæus, Mr Don's memoir on the classification and division of, - 533
 ——— generic characters of, - - - 538

Z

- Zircon found in the Island of Scalpay, - - - 578



